

# AS5304/AS5306

## Integrated Hall ICs for Linear and Off-Axis Rotary Motion Detection

### General Description

The AS5304/AS5306 are single-chip ICs with integrated Hall elements for measuring linear or rotary motion using multi-pole magnetic strips or rings. This allows the usage of the AS5304/AS5306 in applications where the Sensor IC cannot be mounted at the end of a rotating device (e.g. at hollow shafts). Instead, the AS5304/AS5306 are mounted off-axis underneath a multi-pole magnetized ring or strip and provides a quadrature incremental output with 40 pulses per pole period at speeds of up to 20 meters/second (AS5304) or 12 meters/second (AS5306).

A single index pulse is generated once for every pole pair at the Index output. Using, for example, a 32pole-pair magnetic ring, the AS5304/AS5306 can provide a resolution of 1280 pulses/revolution, which is equivalent to 5120 positions/revolution or 12.3bit. The maximum speed at this configuration is 9375 rpm.

The pole pair length is 4mm (2mm north pole / 2mm south pole) for the AS5304, and 2.4mm (1.2mm north pole / 1.2mm south pole) for the AS5306. The chip accepts a magnetic field strength down to 5mT (peak). Both chips are available with **push-pull outputs (AS5304A)** or with **open drain outputs (AS530xB)**. The AS5304/AS5306 are available in a small 20-pin TSSOP package and specified for an operating ambient temperature of -40°C to 125°C.

*Ordering Information and Content Guide appear at end of datasheet.*

## Key Benefits and Features

The benefits and features of this device are listed below:

**Figure 1:**  
Added Value of Using AS5304/AS5306

Benefits	Features
<ul style="list-style-type: none"> <li>• Contactless motion and position sensing</li> </ul>	<ul style="list-style-type: none"> <li>• Highest reliability and durability in harsh environments</li> </ul>
<ul style="list-style-type: none"> <li>• High speed measurement</li> </ul>	<ul style="list-style-type: none"> <li>• Control of high speed movements</li> </ul>
<ul style="list-style-type: none"> <li>• Robust against external magnetic stray fields</li> </ul>	<ul style="list-style-type: none"> <li>• Lower material cost (no magnetic shielding needed)</li> </ul>

- High speed, up to 20m/s (AS5304), 12m/s (AS5306)
- Magnetic pole pair length: **4mm (AS5304)** or **2.4mm (AS5306)**
- Resolution: **25µm (AS5304)** or **15µm (AS5306)**
- 40 pulses / 160 positions per magnetic period
- 1 index pulse per pole pair
- Linear movement measurement using multi-pole magnetic strips
- Circular off-axis movement measurement using multi-pole magnetic rings
- 4.5V to 5.5V operating voltage
- Magnetic field strength indicator, magnetic field alarm for end-of-strip or missing magnet

## Applications

The AS5304 and AS5306 are ideal for high speed linear motion and off-axis rotation measurement in applications, such as electrical motors, X-Y-stages, rotation knobs, and industrial drives.

### Block Diagram

The functional blocks of the AS5304 and AS5306 are shown below:

**Figure 2:**  
Functional Blocks of the AS5304/06

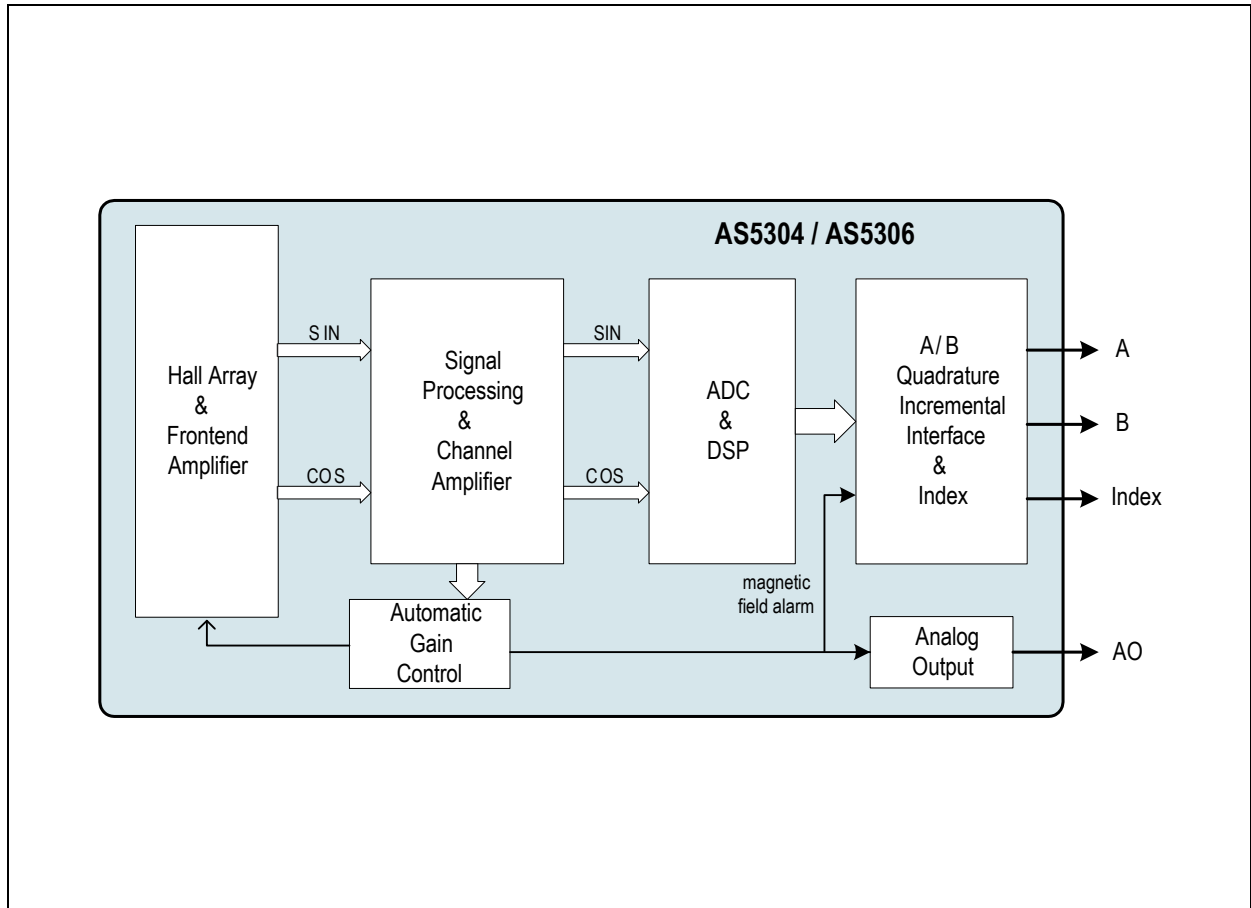

## Pin Assignments

**Figure 3:**  
Pin Assignments (Top View)

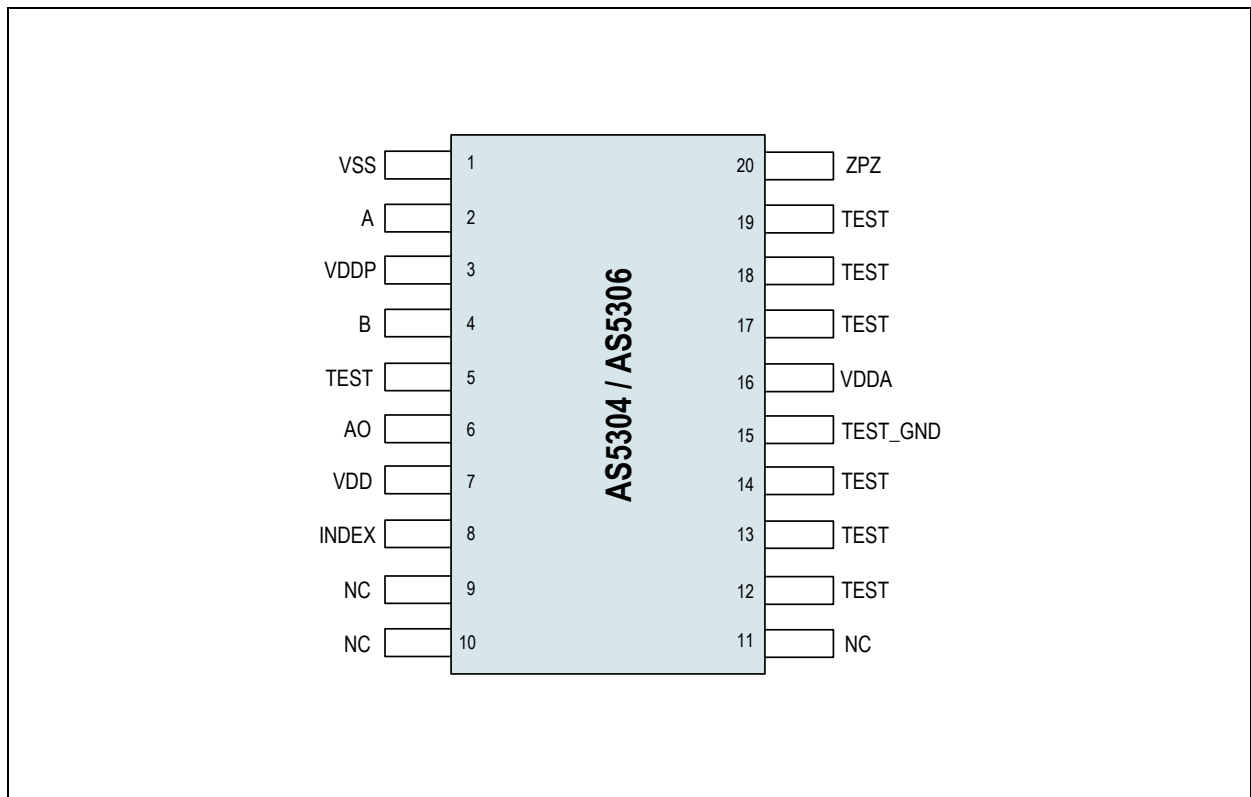

**Figure 4:**  
Pin Description

Pin Number	Pin Name	Pin Type	Description
1	VSS	Supply pin	Supply ground
2	A	Digital output push pull or open drain (programmable)	Incremental quadrature position output A. Short circuit current limitation
3	VDDP	Supply pin	Peripheral supply pin, connect to VDD
4	B	Digital output push pull or open drain (programmable)	Incremental quadrature position output B. Short Circuit Current Limitation
5,12,13,14,17,18,19	TEST	Analog input/output	Test pins, must be left open
6	AO	Analog output	AGC Analog Output. (Used to detect low magnetic field strength)
7	VDD	Supply pin	Positive supply pin
8	Index	Digital output push pull or open drain (programmable)	Index output, active HIGH. Short Circuit Current Limitation

Pin Number	Pin Name	Pin Type	Description
9,10,11	TEST	Analog input/output	Test pins, must be left open
15	TEST_GND	Supply pin	Test pin, must be connected to VSS
16	VDDA Hall		Hall Bias Supply Support (connected to VDD)
20	ZPZmskdis	Digital input	Test input, connect to VSS during operation

## Absolute Maximum Ratings

Stresses beyond those listed under [Absolute Maximum Ratings](#) may cause permanent damage to the device. These are stress ratings only. Functional operation of the device at these or any other conditions beyond those indicated under [Electrical Characteristics](#) is not implied. Exposure to absolute maximum rating conditions for extended periods may affect device reliability.

**Figure 5:**  
Absolute Maximum Ratings

Symbol	Parameter	Min	Max	Units	Comments
VDD	Supply	-0.3	7	V	
V <sub>in</sub>	Input pin voltage	VSS-0.5	VDD+0.5	V	
I <sub>scr</sub>	Input current (latchup immunity)	-100	100	mA	JESD78
ESD <sub>HBM</sub>	Electrostatic discharge (human body model)	±2		kV	MIL 883 E method 3015
Θ <sub>JA</sub>	Package thermal resistance		114.5	°C /W	Still Air / Single Layer PCB
T <sub>strg</sub>	Storage temperature	-55	150	°C	
T <sub>body</sub>	Soldering conditions		260	°C	IPC/JEDEC J-STD-020
RH <sub>NC</sub>	Relative Humidity non-condensing	5	85	%	
MSL	Moisture Sensitivity Level	3			Represents a maximum floor life time of 168h

## Electrical Characteristics

All limits are guaranteed. The parameters with min and max values are guaranteed with production tests or SQC (Statistical Quality Control) methods.

## Operating Conditions

**Figure 6:**  
Operating Conditions

Symbol	Parameter	Conditions	Min	Typ	Max	Unit
AVDD	Positive supply voltage		4.5	5.0	5.5	V
DVDD	Digital supply voltage					
VSS	Negative supply voltage		0.0	0.0	0.0	V
IDD	Power supply current, AS5304	A/B/Index, AO unloaded!	25		35	mA
	Power supply current, AS5306					
T <sub>amb</sub>	Ambient temperature		-40		125	°C
T <sub>J</sub>	Junction temperature		-40		150	°C
LSB	Resolution	AS5304		25		µm
		AS5306		15		
INL	Integral nonlinearity	Ideal input signal (ErrMax - ErrMin) / 2			2.5	LSB
DNL	Differential nonlinearity	No missing pulses. Optimum alignment			±0.5	LSB
Hyst	Hysteresis		1	1.5	2	LSB

## System Parameters

**Figure 7:**  
System Parameters

Symbol	Parameter	Conditions	Min	Typ	Max	Unit
T <sub>PwrUp</sub>	Power up time	Amplitude within valid range / Interpolator locked, A B Index enabled			500	µs
T <sub>Prop</sub>	Propagation delay	Time between change of input signal to output signal			20	µs

### A / B / C Push/Pull or Open Drain Output

Push Pull Mode is set for AS5304A, Open Drain Mode is set for AS530xB versions.

**Figure 8:**  
Open Drain Output

Symbol	Parameter	Conditions	Min	Typ	Max	Unit
$V_{OH}$	High level output voltage	Push/Pull mode	0.8 VDD			V
$V_{OL}$	Low level output voltage				0.4 + VSS	V
$I_{LOH}$	Current source capability	Push/Pull mode	12	14		mA
$I_{LOL}$	Current sink capability		13	15		mA
$I_{Short}$	Short circuit limitation current	Reduces maximum operating temperature		25	39	mA
$C_L$	Capacitive load	see Figure 9		20		pF
$R_L$	Load resistance	see Figure 9		820		$\Omega$
$t_R$	Rise time	Push/Pull mode			1.2	$\mu s$
$t_F$	Fall time				1.2	$\mu s$

**Figure 9:**  
Typical Digital Load

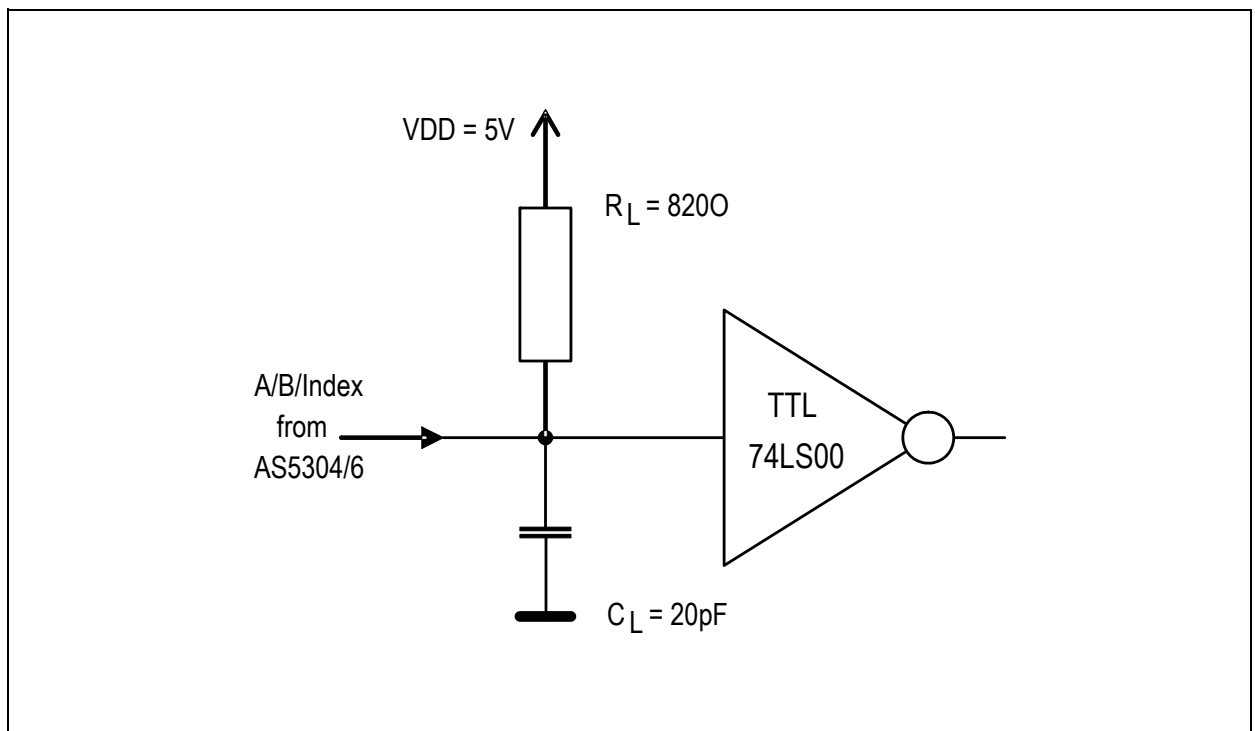



## CAO Analog Output Buffer

**Figure 10:**  
CAO Analog Output Buffer

Symbol	Parameter	Conditions	Min	Typ	Max	Unit
$V_{OutRange}$	Minimum output voltage	Strong field, minimum AGC	0.5	1	1.2	V
$V_{OutRange}$	Maximum output voltage	Weak field, maximum AGC	3	4	5.1	V
$V_{Offs}$	Offset				±10	mV
$I_L$	Current sink / source capability		5			mA
$I_{Short}$	Average short circuit current	Reduces maximum operating temperature	6		40	mA
$C_L$	Capacitive load			10		pF
BW	Bandwidth			5		kHz

## Magnetic Input

**Figure 11:**  
Magnetic Input

Symbol	Parameter	Conditions	Min	Typ	Max	Unit
$L_{P\_FP}$	Magnetic pole length	AS5304		2.0		mm
		AS5306		1.2		
$T_{FP}$	Magnetic pole pair length	AS5304		4.0		mm
		AS5306		2.4		
$A_{mag}$	Magnetic amplitude		10		60	mT
	Operating dynamic input range		1:6		1:12	
$Off_{mag}$	Magnetic offset				±0.5	mT
$T_{dmag}$	Magnetic temperature drift				-0.2	%/K
$f_{mag}$	Input frequency		0		5	kHz

## Detailed Description

The AS5304/AS5306 require a multi-pole magnetic strip or ring with a pole length of 2mm (4mm pole pair length) on the AS5304, and a pole length of 1.2mm (2.4mm pole pair length) on the AS5306. The magnetic field strength of the multi-pole magnet should be in the range of 5mT to 60mT at the chip surface.

The Hall elements on the AS5304/AS5306 are arranged in a linear array.

By moving the multi-pole magnet over the Hall array, a sinusoidal signal (SIN) is generated internally. With proper configuration of the Hall elements, a second 90° phase shifted sinusoidal signal (COS) is obtained. Using an interpolation circuit, the length of a pole pair is divided into 160 positions and further decoded into 40 quadrature pulses.

An Automatic Gain Control provides a large dynamic input range of the magnetic field.

An Analog output pin (AO) provides an analog voltage that changes with the strength of the magnetic field (see [The AO Output](#)).

## Electrical Connection

The supply pins VDD, VDDP and VDDA are connected to +5V. Pins VSS and TEST\_GND are connected to the supply ground. A 100nF decoupling capacitor close to the device is recommended.

**Figure 12:**  
Electrical Connection of the AS5304 / AS5306

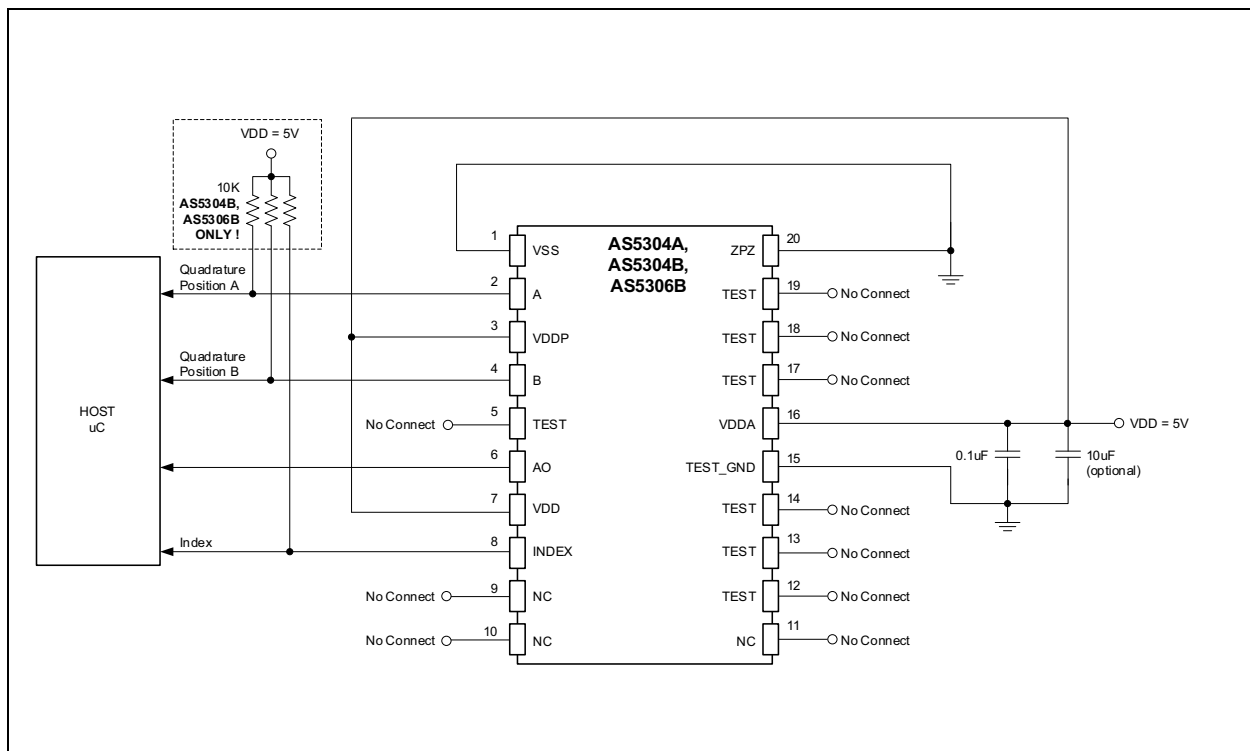

## Incremental Quadrature AB Output

The digital output is compatible to optical incremental encoder outputs. Direction of rotation is encoded into two signals A and B that are phase-shifted by 90°. Depending on the direction of rotation, A leads B (CW) or B leads A (CCW).

### *Index Pulse*

A single index pulse is generated once for every pole pair. One pole pair is interpolated to 40 quadrature pulses (160 steps), so one index pulse is generated after every 40 quadrature pulses (see [Figure 13](#)).

The Index output is switched to Index = high, when a magnet is placed over the Hall array as shown in [Figure 14](#), top graph: the north pole of the magnet is placed over the left side of the IC (top view, pin#1 at bottom left) and the south pole is placed over the right side of the IC.

The index output will switch back to Index = low, when the magnet is moved by one LSB from position  $X=0$  to  $X=X1$ , as shown in [Figure 14](#), bottom graph. One LSB is 25 $\mu\text{m}$  for AS5304 and 15 $\mu\text{m}$  for AS5306.

**Note(s):** Since the small step size of 1 LSB is hardly recognizable in a correctly scaled graph it is shown as an exaggerated step in the bottom graph of [Figure 14](#).

Figure 13:  
Quadrature A / B and Index Output

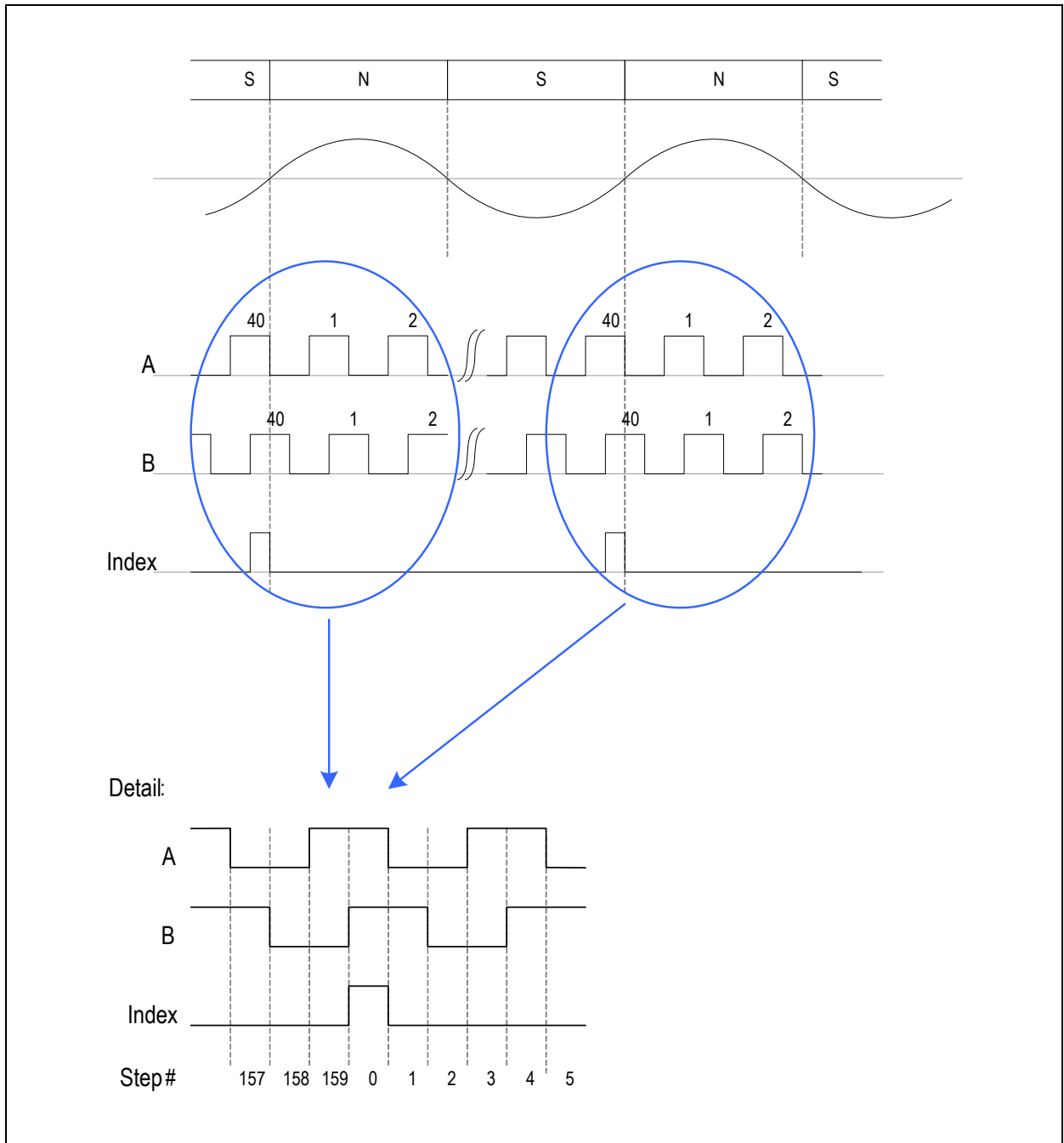

### ***Magnetic Field Warning Indicator***

The AS5304 can also provide a low magnetic field warning to indicate a missing magnet or when the end of the magnetic strip has been reached. This condition is indicated by using a combination of A, B and Index, that does not occur in normal operation:

A low magnetic field is indicated with:

Index = high

A=B=low

### ***Vertical Distance between Magnet and IC***

The recommended vertical distance between magnet and IC depends on the strength of the magnet and the length of the magnetic pole.

Typically, the vertical distance between magnet and chip surface should not exceed  $\frac{1}{2}$  of the pole length. That means for AS5304, having a pole length of 2.0mm, the maximum vertical gap should be 1.0mm. For the AS5306, having a pole length of 1.2mm, the maximum vertical gap should be 0.6mm. These figures refer to the chip surface. Given a typical distance of 0.2mm between chip surface and IC package surface, the recommended vertical distances between **magnet and IC surface** are therefore:

AS 5304:  $\leq 0.8\text{mm}$

AS 5306:  $\leq 0.4\text{mm}$

**Figure 14:**  
Magnet Placement for Index Pulse Generation

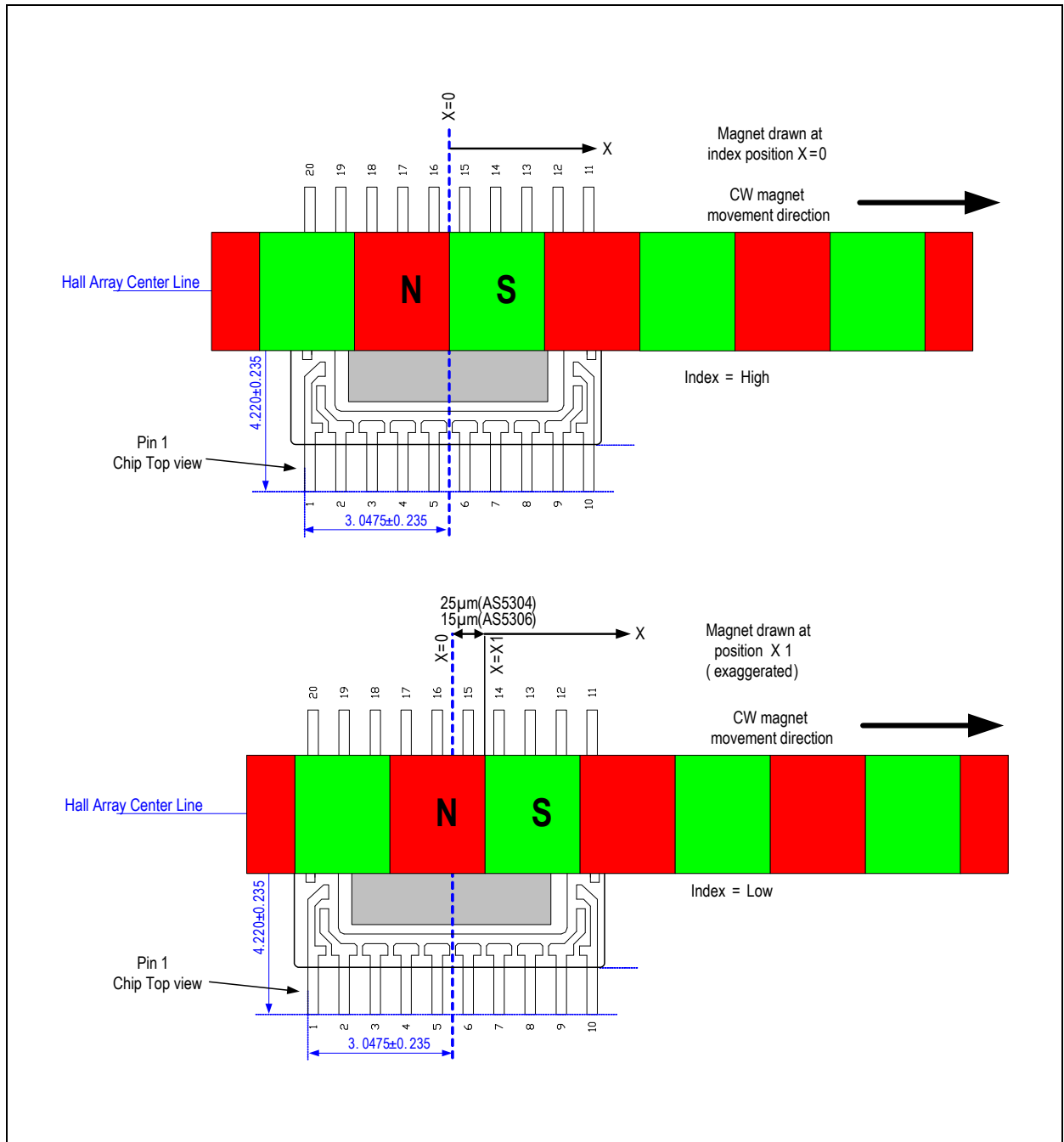

### **Soft Stop Feature for Linear Movement Measurement**

When using long multi-pole strips, it may often be necessary to start from a defined home (or zero) position and obtain absolute position information by counting the steps from the defined home position. The AS5304/AS5306 provide a soft stop feature that eliminates the need for a separate electro-mechanical home position switch or an optical light barrier switch to indicate the home position.

The magnetic field warning indicator (see [Magnetic Field Warning Indicator](#)) together with the index pulse can be used to indicate a unique home position on a magnetic strip:

1. Firstly, the AS5304/AS5306 move to the end of the strip until a magnetic field warning is displayed (Index = high, A=B=low).
2. Then, the AS5304/AS5306 move back towards the strip until the first index position is reached (Note that an index position is generated once for every pole pair, it is indicated with: Index = high, A=B= high). Depending on the polarity of the strip magnet, the first index position may be generated when the end of the magnet strip only covers one half of the Hall array. This position is not recommended as a defined home position, as the accuracy of the AS5304/AS5306 are reduced as long as the multi-pole strip does not fully cover the Hall array.
3. It is therefore recommended to continue to the next (second) index position from the end of the strip (Index = high, A=B= high). This position can now be used as a defined home position.

### **Incremental Hysteresis**

If the magnet is sitting right at the transition point between two steps, the noise in the system may cause the incremental outputs to jitter back and forth between these two steps, especially when the magnetic field is weak.

To avoid this unwanted jitter, a hysteresis has been implemented. The hysteresis lies between 1 and 2 LSB, depending on device scattering. [Figure 15](#) shows an example of 1LSB hysteresis: the horizontal axis is the lateral position of the magnet as it scans across the IC, the vertical axis is the change of the incremental outputs, as they step forward (blue line) with movement in +X direction and backward (red line) in -X direction.

**Note(s):** 1LSB = 25µm for AS5304, 15µm for AS5306

**Figure 15:**  
Hysteresis of the Incremental Output

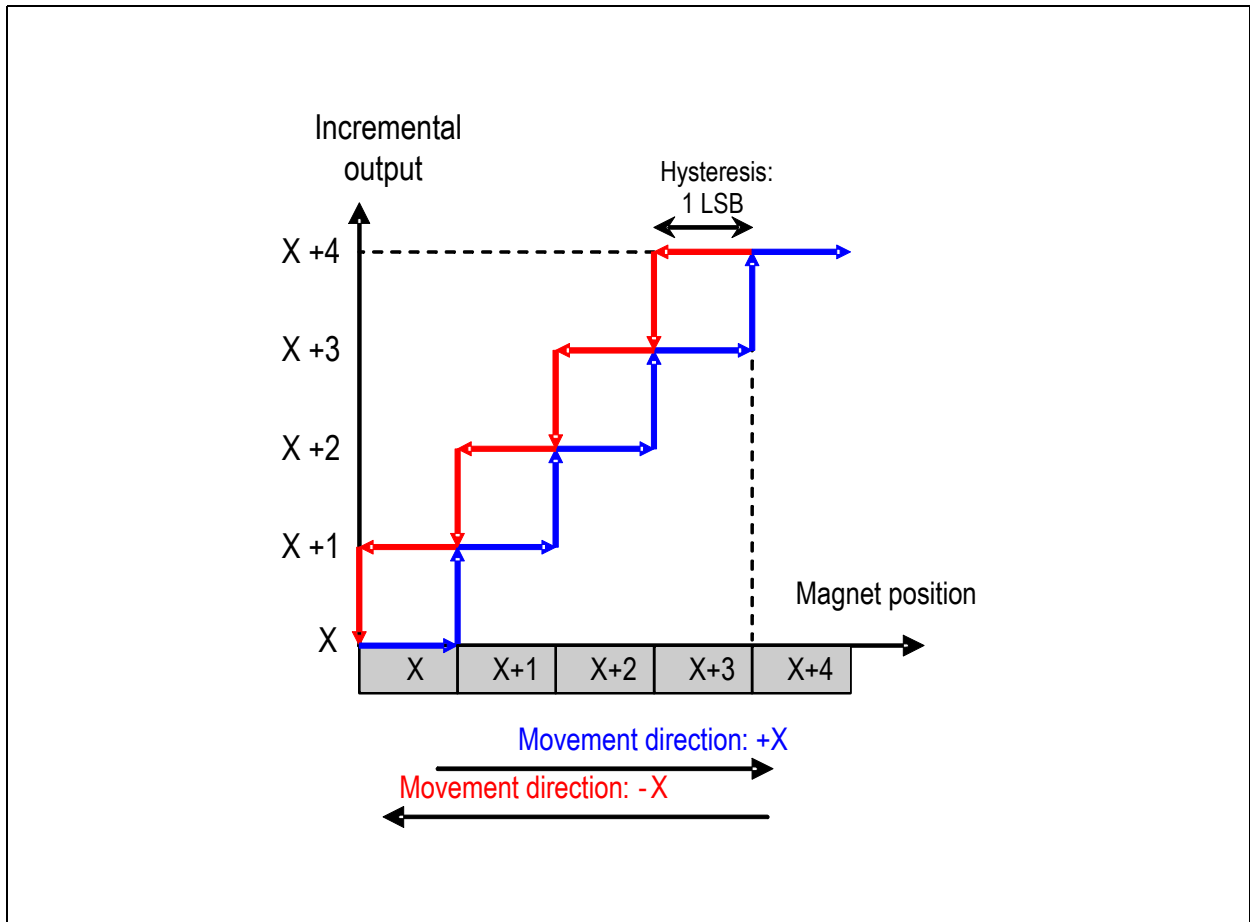

**Integral Non-Linearity (INL)**

The INL (integral non-linearity) is the deviation between indicated position and actual position. It is better than 1LSB for both AS5304 and AS5306, assuming an ideal magnet. Pole length variations and imperfections of the magnet material, which lead to a non-sinusoidal magnetic field will attribute to additional linearity errors.

**Error Caused by Pole Length Variations**

Figure 16 and Figure 17 show the error caused by a non-ideal pole length of the multi-pole strip or ring. This is less of an issue with strip magnets, as they can be manufactured exactly to specification using the proper magnetization tooling.



**Figure 16:**  
**Additional Error Caused by Pole Length Variation: AS5304**

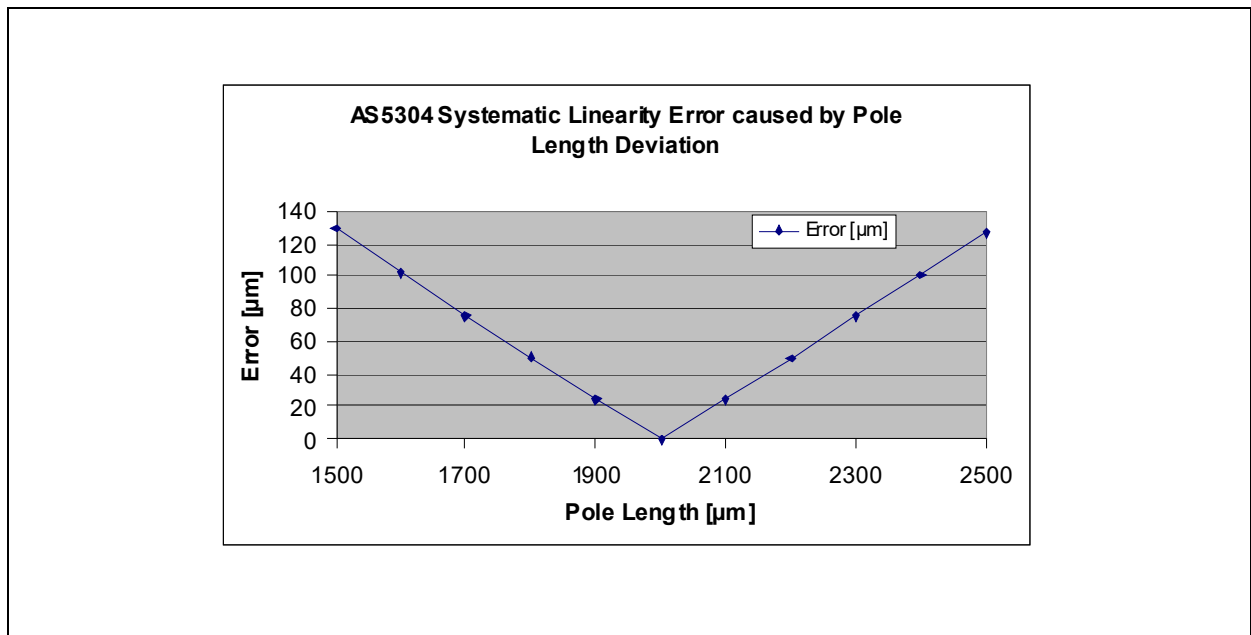

However, when using a ring magnet (see Figure 20), the pole length differs depending on the measurement radius. For optimum performance, it is therefore essential to mount the IC such that the Hall sensors are exactly underneath the magnet at the radius where the pole length is 2.0mm (AS5304) or 1.2mm (AS5306), see also [Multi-Pole Ring Diameter](#).

**Note(s):** This is an additional error, which must be added to the intrinsic errors INL (page 16) and DNL (page 18).

**Figure 17:**  
**Additional Error Caused by Pole Length Variation: AS5306**

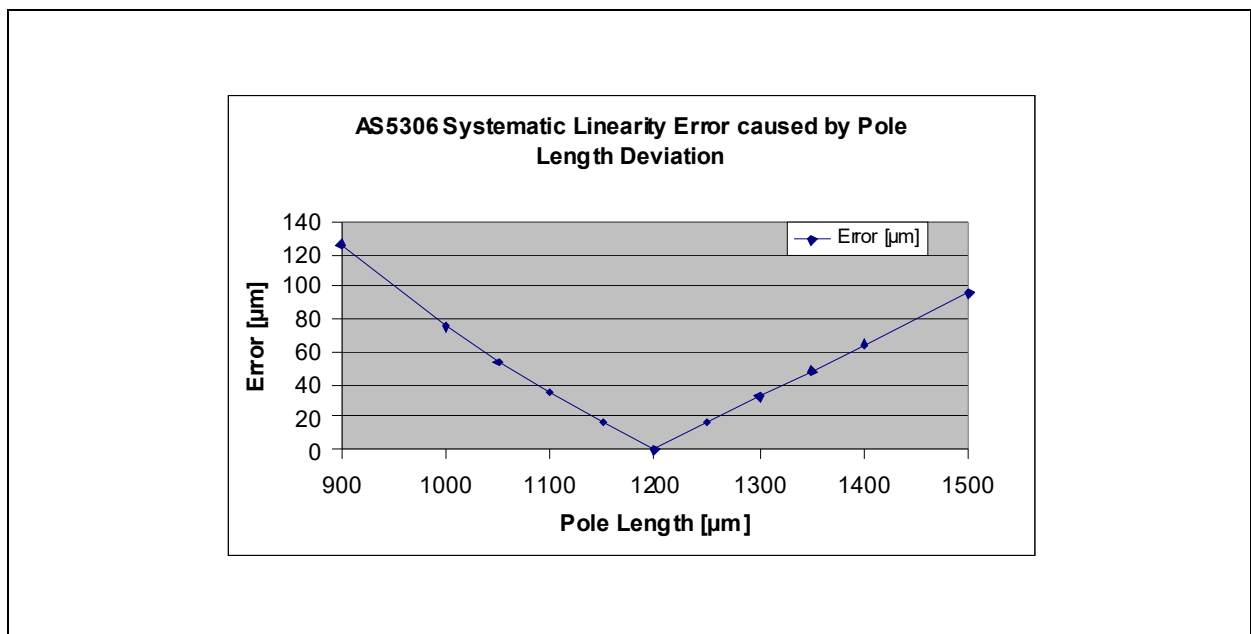

### Dynamic Non-Linearity (DNL)

The DNL (dynamic non-linearity) describes the non-linearity of the incremental outputs from one step to the next. In an ideal system, every change of the incremental outputs would occur after exactly one LSB (e.g. 25µm on AS5304). In practice however, this step size is not ideal, the output state will change after  $1\text{LSB} \pm \text{DNL}$ . The DNL must be  $< \pm 1/2$  LSB to avoid a missing code. Consequently, the incremental outputs will change when the magnet movement over the IC is minimum 0.5 LSB and maximum 1.5 LSBs.

**Figure 18:**  
DNL of AS5304 (left) and AS5306 (right)

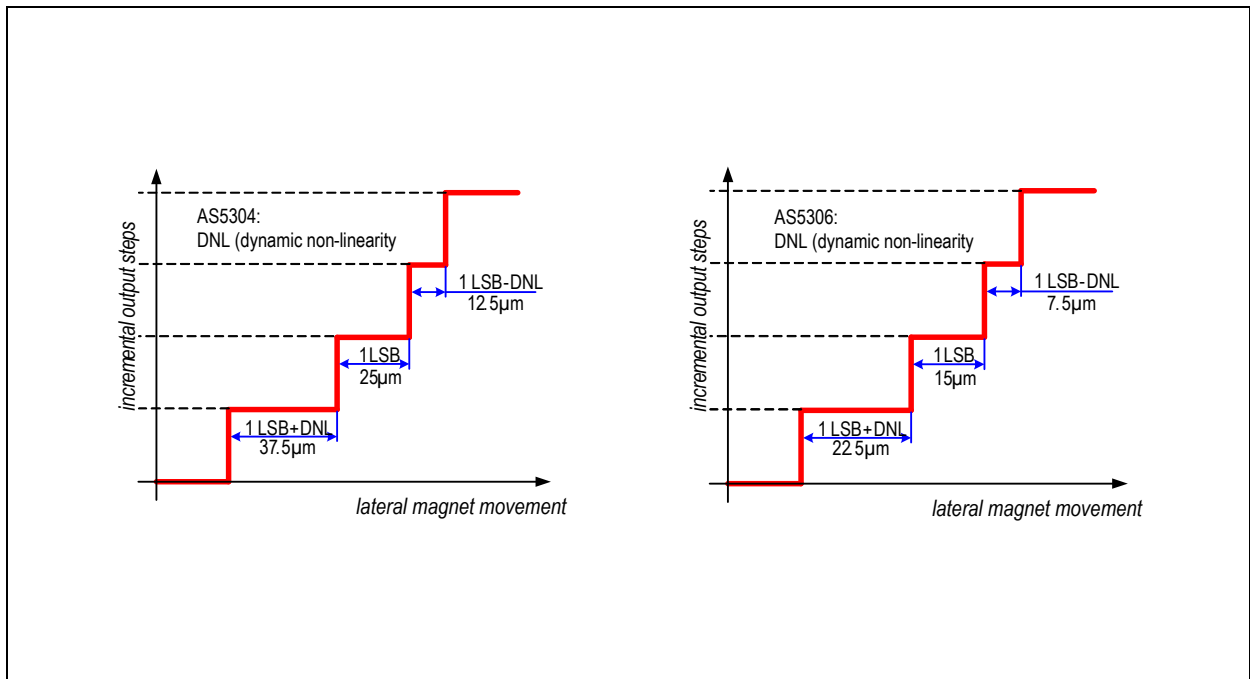

## The AO Output

The Analog Output (AO) provides an analog output voltage that represents the Automatic Gain Control (AGC) of the Hall sensors signal control loop.

This voltage can be used to monitor the magnetic field strength and hence the gap between magnet and chip surface:

- Short distance between magnet and IC -> strong magnetic field -> low loop gain -> low AO voltage
- Long distance between magnet and IC -> weak magnetic field -> high loop gain -> high AO voltage

**Figure 19:**  
AO vs. AGC, Magnetic Field Strength, Magnet-to-IC Gap

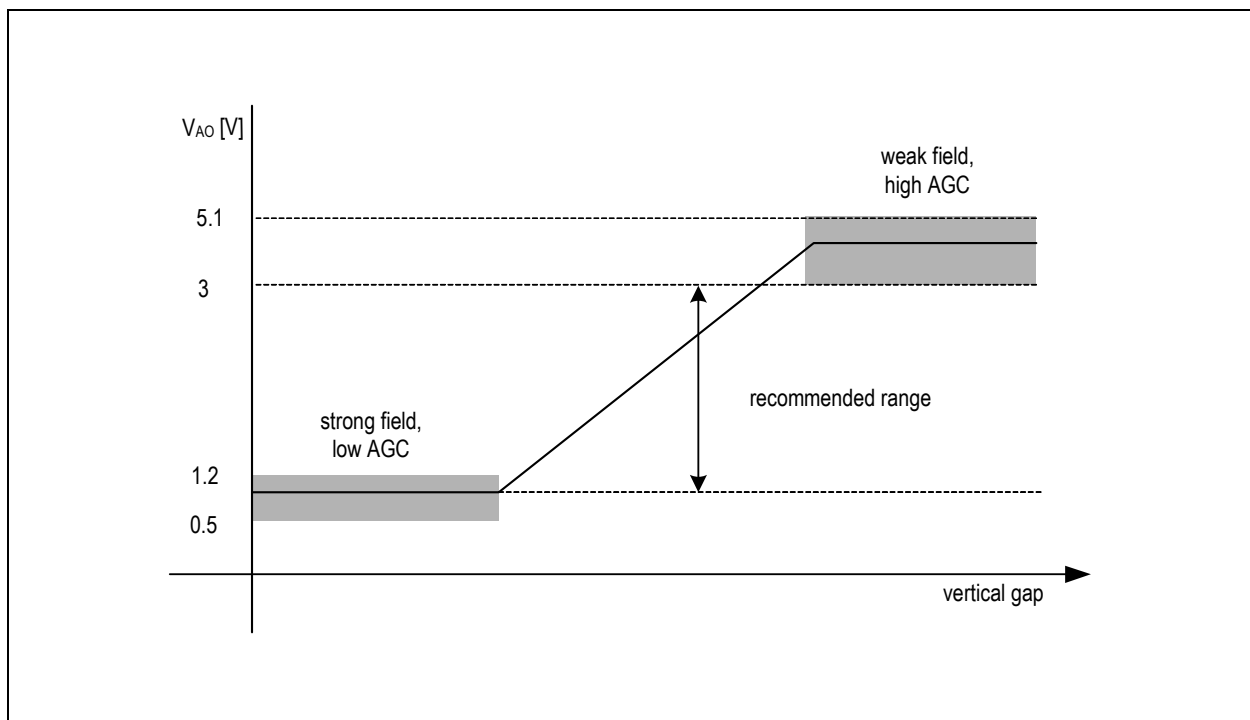

**Application Information**

**Figure 20:**  
AS5304 (AS5306) with Multi-Pole Ring Magnet



**Figure 21:**  
AS5306 (AS5304) with Magnetic Multi-Pole Strip Magnet for Linear Motion Measurement

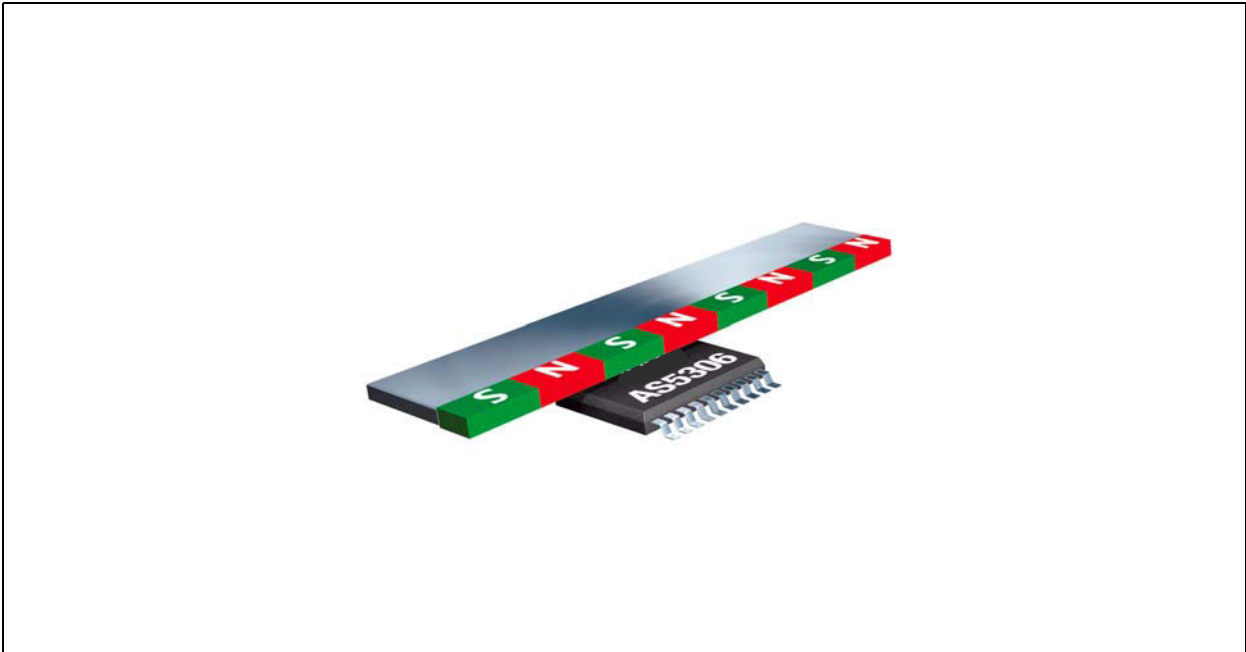

## Resolution and Maximum Rotating Speed

When using the AS5304/AS5306 in an off-axis rotary application, a multi-pole ring magnet must be used. Resolution, diameter and maximum speed depend on the number of pole pairs on the ring.

### Resolution

The angular resolution increases linearly with the number of pole pairs. One pole pair has a resolution (= interpolation factor) of 160 steps or 40 quadrature pulses.

**Resolution [steps] = [interpolation factor] x [number of pole pairs]**

**Resolution [bit] = log (resolution[steps]) / log (2)**

*Example:* Multi-pole ring with 22 pole pairs

Resolution = 160x22 = 3520 steps per revolution  
 = 40x22 = 880 quadrature pulses / revolution  
 = 11.78 bits per revolution = 0.1023° per step

### Multi-Pole Ring Diameter

The length of a pole pair across the median of the multi-pole ring must remain fixed at either 4mm (AS5304) or 2.4mm (AS5306). Hence, with increasing pole pair count, the diameter increases linearly with the number of pole pairs on the magnetic ring.

**Magnetic ring diameter = [pole length] \* [number of pole pairs] /  $\pi$**

for AS5304:  $d = 4.0\text{mm} * \text{number of pole pairs} / \pi$

for AS5306:  $d = 2.4\text{mm} * \text{number of pole pairs} / \pi$

*Example:* (same as above) Multi-pole ring with 22 pole pairs for AS5304

Ring diameter =  $4 * 22 / 3.14 = 28.01\text{mm}$  (this number represents the median diameter of the ring, this is where the Hall elements of the AS5304/AS5306 should be placed; [\(see Figure 25\)](#)).

For the AS5306, the same ring would have a diameter of:  
 $2.4 * 22 / 3.14 = 16.8\text{mm}$

**Maximum Rotation Speed**

The AS5304/AS5306 use a fast interpolation technique allowing an input frequency of 5kHz. This means, it can process magnetic field changes in the order of 5000 pole pairs per second or 300000 revolutions per minute. However, since a magnetic ring consists of more than one pole pair, the above value must be divided by the number of pole pairs to get the maximum rotation speed:

**Maximum rotation speed = 300000 rpm / [number of pole pairs]**

*Example:* (same as above) Multi-pole ring with 22 pole pairs:

Maximum speed =  $300000 / 22 = 13636$  rpm (this is independent of the pole length)

**Maximum Linear Travelling Speed**

For linear motion sensing, a multi-pole strip using equally spaced north and south poles is used. The pole length is again fixed at 2.0mm for the AS5304 and 1.2mm for the AS5306. As shown in [Maximum Rotation Speed](#) above, the sensors can process up to 5000 pole pairs per second, so the maximum travelling speed is:

**Maximum linear travelling speed = 5000 \* [pole pair length]**

*Example:* Linear multi-pole strip:

Maximum linear travelling speed =  $4\text{mm} * 5000 \text{ 1/s} = 20000\text{mm/s} = 20\text{m/s}$  {for AS5304}

Maximum linear travelling speed =  $2.4\text{mm} * 5000 \text{ 1/s} = 12000\text{mm/s} = 12\text{m/s}$  {for AS5306}

**Package Drawings & Markings** The devices are available in a 20-pin TSSOP package.

**Figure 22:**  
Packaging Drawings and Dimensions

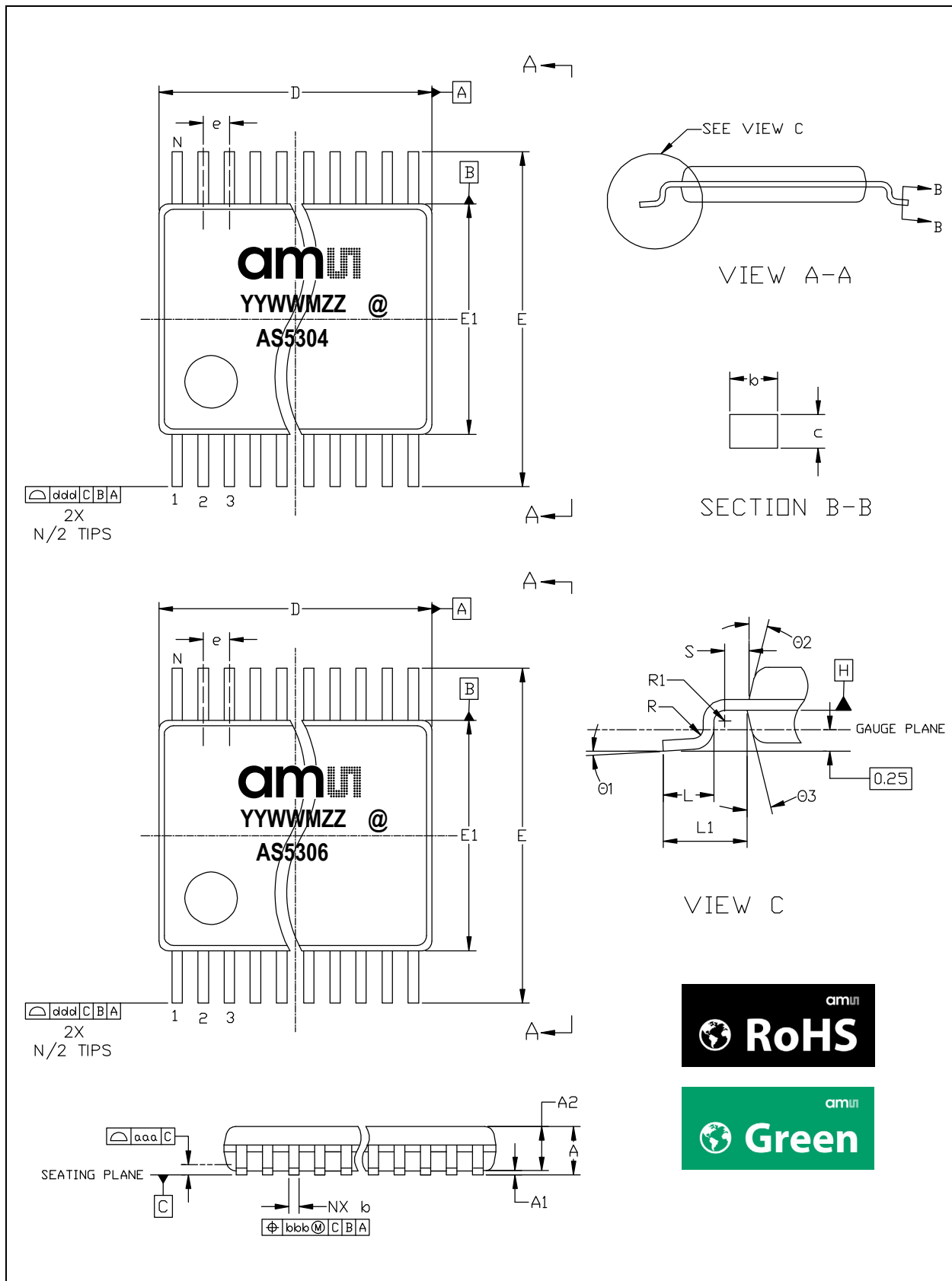

**Figure 23:**  
Package Dimensions

Symbol	Min	Nom	Max
A	-	-	1.20
A1	0.05	-	0.15
A2	0.80	1.00	1.05
b	0.19	-	0.30
c	0.09	-	0.20
D	6.40	6.50	6.60
E	-	6.40 BSC	-
E1	4.30	4.40	4.50
e	-	0.65 BSC	-
L	0.45	0.60	0.75
L1	-	1.00 REF	-

Symbol	Min	Nom	Max
R	0.09	-	-
R1	0.09	-	-
S	0.20	-	-
q1	0°	-	8°
θ2	-	12 REF	-
θ3	-	12 REF	-
aaa	-	0.10	-
bbb	-	0.10	-
ccc	-	0.05	-
ddd	-	0.20	-
N	20		

**Note(s):**

1. Dimensions and tolerancing conform to ASME Y14.5M-1994.
2. All dimensions are in millimeters. Angles are in degrees.

**Figure 24:**  
Packaging Code

YY	WW	M	ZZ	@
Year	Manufacturing Week	Assembly Plant Identifier	Assembly Traceability Code	Sublot Identifier



### Sensor Placement in Package

TSSOP20 / 0.65mm pin pitch

**Figure 25:**  
Sensor in Package

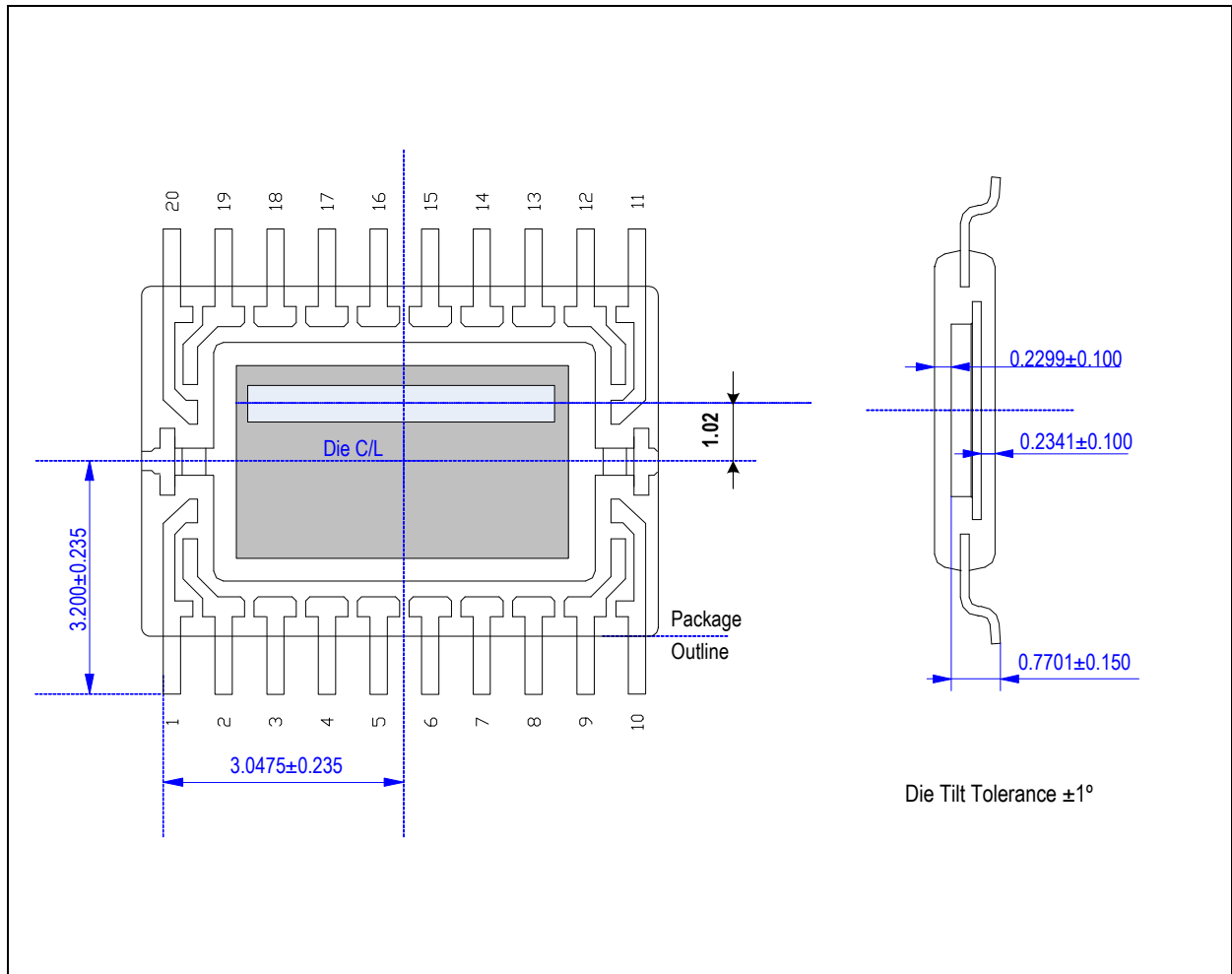

## Ordering & Contact Information

The devices are available as the standard products shown in the below figure.

Figure 26:  
Ordering Information

Ordering Code	Package	Description	Delivery Form	Delivery Quantity
<b>AS5304</b>				
AS5304A	20-pin TSSOP	25µm resolution, 2mm Magnet pole length, Push Pull	Tape & Reel	500 pcs/reel
AS5304B	20-pin TSSOP	25µm resolution, 2mm Magnet pole length, Open Drain	Tape & Reel	4500 pcs/reel 500 pcs/reel
<b>AS5306</b>				
AS5306B	20-pin TSSOP	15µm resolution, 1.2mm Magnet pole length, Open Drain	Tape & Reel	4500 pcs/reel

Buy our products or get free samples online at:

[www.ams.com/Products](http://www.ams.com/Products)

Technical Support is available at:

[www.ams.com/Technical-Support](http://www.ams.com/Technical-Support)

Provide feedback about this document at:

[www.ams.com/Document-Feedback](http://www.ams.com/Document-Feedback)

For further information and requests, e-mail us at:

[ams\\_sales@ams.com](mailto:ams_sales@ams.com)

For sales offices, distributors and representatives, please visit:

[www.ams.com/Contact](http://www.ams.com/Contact)

### Headquarters

ams-OSRAM AG  
Tobelbader Strasse 30  
8141 Premstaetten  
Austria, Europe

Tel: +43 (0) 3136 500 0

Website: [www.ams.com](http://www.ams.com)

## RoHS Compliant & ams Green Statement

**RoHS:** The term RoHS compliant means that ams-OSRAM AG products fully comply with current RoHS directives. Our semiconductor products do not contain any chemicals for all 6 substance categories plus additional 4 substance categories (per amendment EU 2015/863), including the requirement that lead not exceed 0.1% by weight in homogeneous materials. Where designed to be soldered at high temperatures, RoHS compliant products are suitable for use in specified lead-free processes.

**ams Green (RoHS compliant and no Sb/Br/Cl):** ams Green defines that in addition to RoHS compliance, our products are free of Bromine (Br) and Antimony (Sb) based flame retardants (Br or Sb do not exceed 0.1% by weight in homogeneous material) and do not contain Chlorine (Cl not exceed 0.1% by weight in homogeneous material).

**Important Information:** The information provided in this statement represents ams-OSRAM AG knowledge and belief as of the date that it is provided. ams-OSRAM AG bases its knowledge and belief on information provided by third parties, and makes no representation or warranty as to the accuracy of such information. Efforts are underway to better integrate information from third parties. ams-OSRAM AG has taken and continues to take reasonable steps to provide representative and accurate information but may not have conducted destructive testing or chemical analysis on incoming materials and chemicals. ams-OSRAM AG and ams-OSRAM AG suppliers consider certain information to be proprietary, and thus CAS numbers and other limited information may not be available for release.

## Copyrights & Disclaimer

Copyright ams-OSRAM AG, Tobelbader Strasse 30, 8141 Premstaetten, Austria-Europe. Trademarks Registered. All rights reserved. The material herein may not be reproduced, adapted, merged, translated, stored, or used without the prior written consent of the copyright owner.

Devices sold by ams-OSRAM AG are covered by the warranty and patent indemnification provisions appearing in its General Terms of Trade. ams-OSRAM AG makes no warranty, express, statutory, implied, or by description regarding the information set forth herein. ams-OSRAM AG reserves the right to change specifications and prices at any time and without notice. Therefore, prior to designing this product into a system, it is necessary to check with ams-OSRAM AG for current information. This product is intended for use in commercial applications. Applications requiring extended temperature range, unusual environmental requirements, or high reliability applications, such as military, medical life-support or life-sustaining equipment are specifically not recommended without additional processing by ams-OSRAM AG for each application. This product is provided by ams-OSRAM AG "AS IS" and any express or implied warranties, including, but not limited to the implied warranties of merchantability and fitness for a particular purpose are disclaimed.

ams-OSRAM AG shall not be liable to recipient or any third party for any damages, including but not limited to personal injury, property damage, loss of profits, loss of use, interruption of business or indirect, special, incidental or consequential damages, of any kind, in connection with or arising out of the furnishing, performance or use of the technical data herein. No obligation or liability to recipient or any third party shall arise or flow out of ams-OSRAM AG rendering of technical or other services.

## Document Status

Document Status	Product Status	Definition
Product Preview	Pre-Development	Information in this datasheet is based on product ideas in the planning phase of development. All specifications are design goals without any warranty and are subject to change without notice
Preliminary Datasheet	Pre-Production	Information in this datasheet is based on products in the design, validation or qualification phase of development. The performance and parameters shown in this document are preliminary without any warranty and are subject to change without notice
Datasheet	Production	Information in this datasheet is based on products in ramp-up to full production or full production which conform to specifications in accordance with the terms of ams-OSRAM AG standard warranty as given in the General Terms of Trade
Datasheet (discontinued)	Discontinued	Information in this datasheet is based on products which conform to specifications in accordance with the terms of ams-OSRAM AG standard warranty as given in the General Terms of Trade, but these products have been superseded and should not be used for new designs

## Revision Information

Changes from 2-00 (2017-May-03) to current revision 3-00 (2022-Jan-24)	Page
Replaced two instances of AS530xA with AS5304A	1, 8
Updated figure 12	10
Updated figure 26	26

**Note(s):**

1. Page and figure numbers for the previous version may differ from page and figure numbers in the current revision.
2. Correction of typographical errors is not explicitly mentioned.

## Content Guide

<b>1</b>	<b>General Description</b>
2	Key Benefits and Features
2	Applications
3	Block Diagram
<b>4</b>	<b>Pin Assignments</b>
<b>6</b>	<b>Absolute Maximum Ratings</b>
<b>7</b>	<b>Electrical Characteristics</b>
7	Operating Conditions
7	System Parameters
8	A / B / C Push/Pull or Open Drain Output
9	CAO Analog Output Buffer
9	Magnetic Input
<b>10</b>	<b>Detailed Description</b>
10	Electrical Connection
11	Incremental Quadrature AB Output
11	Index Pulse
13	Magnetic Field Warning Indicator
13	Vertical Distance between Magnet and IC
15	Soft Stop Feature for Linear Movement Measurement
15	Incremental Hysteresis
16	Integral Non-Linearity (INL)
16	Error Caused by Pole Length Variations
18	Dynamic Non-Linearity (DNL)
19	The AO Output
<b>20</b>	<b>Application Information</b>
21	Resolution and Maximum Rotating Speed
21	Resolution
21	Multi-Pole Ring Diameter
22	Maximum Rotation Speed
22	Maximum Linear Travelling Speed
<b>23</b>	<b>Package Drawings &amp; Markings</b>
25	Sensor Placement in Package
<b>26</b>	<b>Ordering &amp; Contact Information</b>
<b>27</b>	<b>RoHS Compliant &amp; ams Green Statement</b>
<b>28</b>	<b>Copyrights &amp; Disclaimer</b>
<b>29</b>	<b>Document Status</b>
<b>30</b>	<b>Revision Information</b>