

Assembly instruction APD 6-/7-way

Fixed connector
Jam nut receptacle

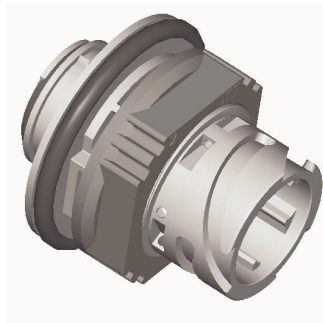

Free connector



Fixed connector
Flange receptacle

APD-1AP6, 6-way for stamped contacts
APD-1AP6-EP 6-way for press in contacts
APD-1AP7-EP 7-way for press in contacts

APD-1AP7, 7-way for stamped contacts

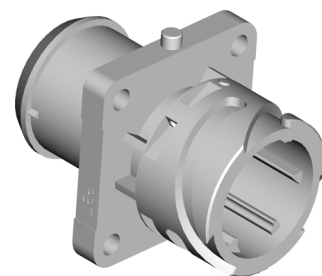
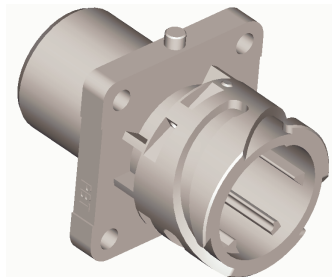

No endbell mountable
Front panel mounting possible

Bearbeitet:
AKU / WD

Geprüft:
NK

Norm:
HES

Änd.-Stand:
-4263W

Änd.-Datum:
11.06.2012



Content

I.) APD 6-/7-way with stamped crimp contacts	3
1.) Connector Types	3
2.) Stamped Crimp Contacts	4
3.) Single Wire Seal	4
4.) Crimp with Hand Crimp Tool	5
5.) Crimp with Crimp Machine	5
6.) Insertion and Extraction of Stamped Contacts	6
II.) Assembly instruction with Press-in Contacts (pin contacts only)	7
1.) Connector Types	7
2.) Press-In Contacts (1,6mm)	7
3.) Stripping the Cable	8
4.) Crimp instruction for Press-in Contacts	8
5.) Insertion of Press-in Contacts	9
III.) Mounting Cut-out and Accessory	10
1.) Mounting Cut-out	10
2.) Flange Sealing	10
3.) Metal Flange Support	10
4.) Blanking Plug (Blind seal, wire filler)	11
5.) Mounting of Jam Nut Receptacle	11
6.) Tools for Tighten the Jam Nut	12
IV.) Product safety and warranty	13



ITT Industries

Assembly instruction

APD 6-/7-way

CAS25022E**I.) APD 6-/7-way with stamped crimp contacts****1.) Connector Types**Fixed connector
Flange receptacle

packaging unit 100 pieces

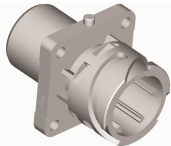
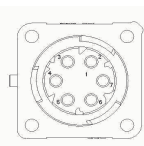
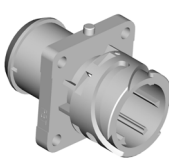
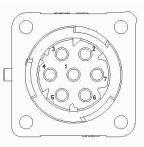
		Order number	Order name.	Code	Colour	
	6-way		120110-0083	APD-1AP6	1	black (1. contact cavity closed)
	7-way		121583-0020	APD-1AP7	1	black

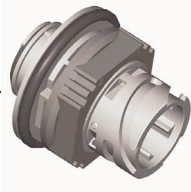
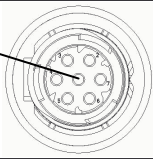
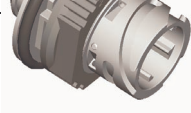
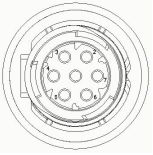

Fixed connector
Jam nut receptacle

packaging unit 100 pieces

		Order number	Order name.	Code	Colour	
	6-way		121583-0061	APD-1CP6	1	black (1. contact cavity closed)
	7-way		121583-0019	APD-1CP7	1	black

Free connector

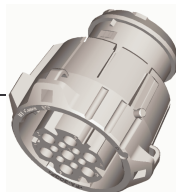
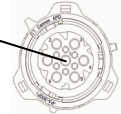
packaging unit 100 pieces

		Order number	Order name.	Code	Colour	
	6-way		120110-0024	APD-1BS6	1	black (1. contact cavity closed)
	7-way		121583-0018	APD-1BS7	1	black

Bearbeitet:
AKU / WDGeprüft:
NKNorm:
HESÄnd.-Stand:
-4263WÄnd.-Datum:
11.06.2012

2.) Stamped Crimp Contacts

The pin and socket contacts are built of high conductive material.

Socket contact, size 1,6mm

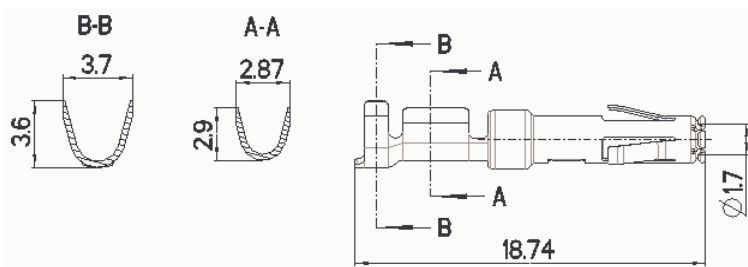

Order number.: 192900-0001
 Crimp diameter: 0,75-1,5mm²
 Standard plating: tinned
 3000 contacts per reel
 Single contact, order number
 192900-0003

Pin contact, size 1,6mm

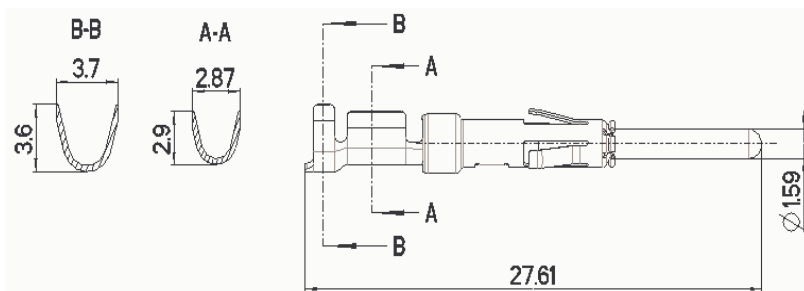

Order number.: 192900-0000
 Crimp diameter: 0,75-1,5mm²
 Standard plating: tinned
 3000 contacts per reel
 Single contact, order number
 192900-0002

The contacts get crimped with insulation crimp. The crimping measurements are the same for pin and socket contacts in uncrimped condition.

3.) Single Wire Seal

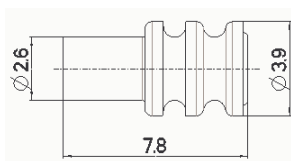

Before skinning the cable, push single wire seal in direction of arrow onto the cable.. (optional)

<u>Bestell-Bez.</u>	<u>Bestell-Nr.</u>
10GR3940	121667-0022
Ø 1,4 – 2,0mm grau	
10YE3940	121667-0023
Ø 1,9 – 2,1mm gelb	
10RD3940	121667-0024
Ø 1,2 – 1,6mm rot	

The single wire sealing is not going to be crimped

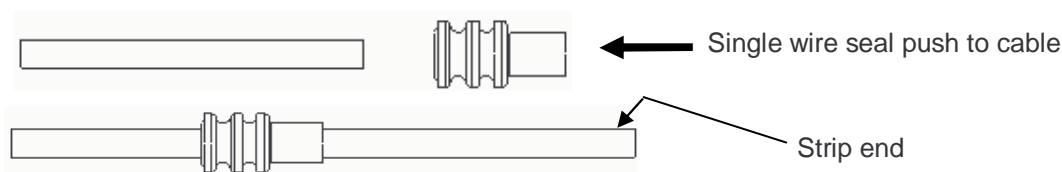

Bearbeitet: AKU / WD	Geprüft: NK	Norm: HES	Änd.-Stand: -4263W	Änd.-Datum: 11.06.2012
-------------------------	----------------	--------------	-----------------------	---------------------------

4.) Crimp with Hand Crimp Tool

Single contacts are going to be crimped with hand crimp tool..



Wire size	Order number.
16-18 AWG; 0,75–1,5mm ²	CHT-Trident 121586-5237

During the processing the crimping specification CAS25047 is to be considered

5.) Crimp with Crimp Machine

For high volume production, crimp machinery with interchangeable crimp tool as the Mecal-TT and WWZ-Mecal-EVS (mini applicator) are used.

Crimp machine Mecal-TT Press



<u>Order name:</u>	<u>Order number:</u>
Mecal-TT	121586-5225

Crimp tool
(mini applicator) WWZ-Mecal-EVS



<u>Order name:</u>	<u>Order number:</u>
WWZ-Mecal-EVS	121586-5217

During the processing the crimping specification CAS25046 is to be considered

Bearbeitet: AKU / WD	Geprüft: NK	Norm: HES	Änd.-Stand: -4263W	Änd.-Datum: 11.06.2012
-------------------------	----------------	--------------	-----------------------	---------------------------

6.) Insertion and Extraction of Stamped Contacts

There is no need of insertion tools.

A.) The stamped contacts get mounted from the rear panel of the connector into the contact cavity by hand until it snaps in. To the front, the contact is bounded by the shoulder at the contact.

B.) Single Wire Seal push into connector housing. (Optional)

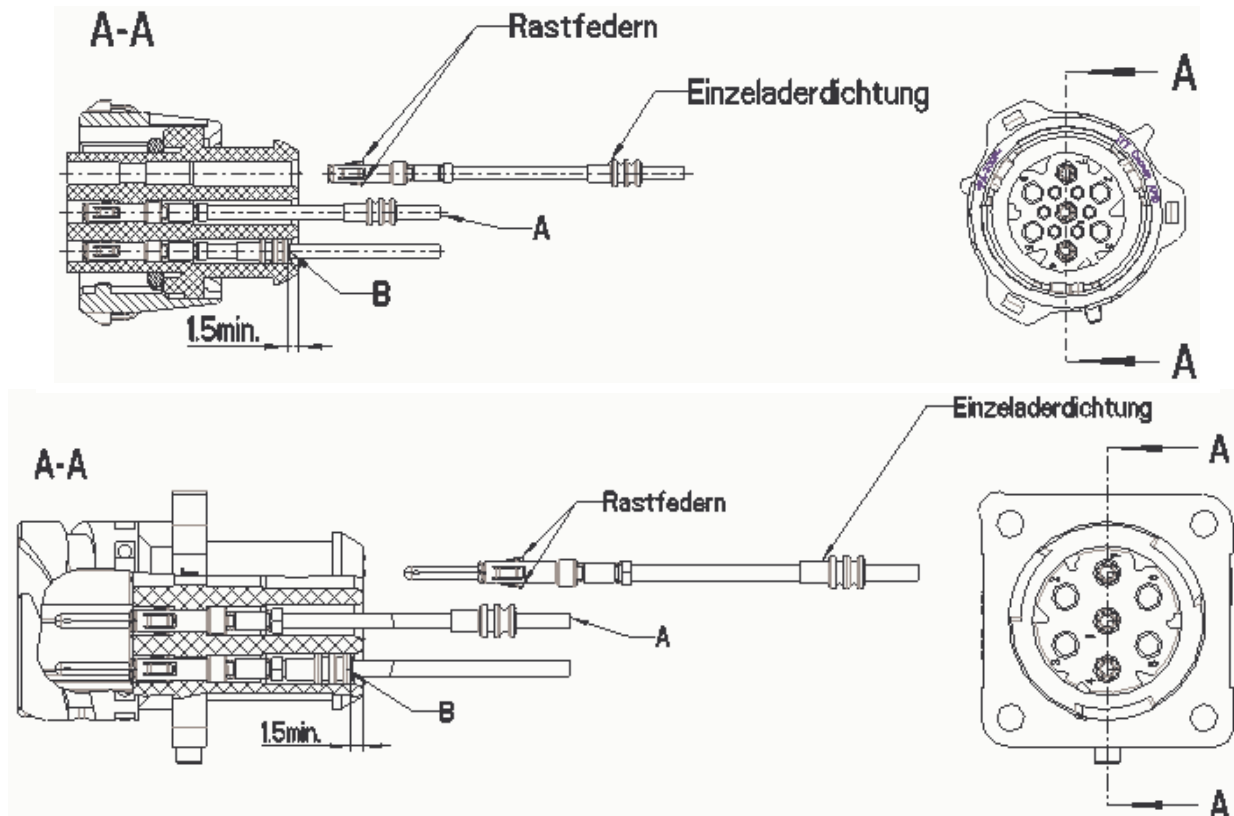

Extraction

The extraction of stamped contacts, pin and socket from the housing occurs from the front with the extraction tool. The extraction tool gets inserted into the contact cavity on the mating face. See [picture 1](#). Eventually the snap springs get clamped and the cable can be pulled out from the cable face. See [picture 2](#).

Extraction tool

Order number: 192922-1450

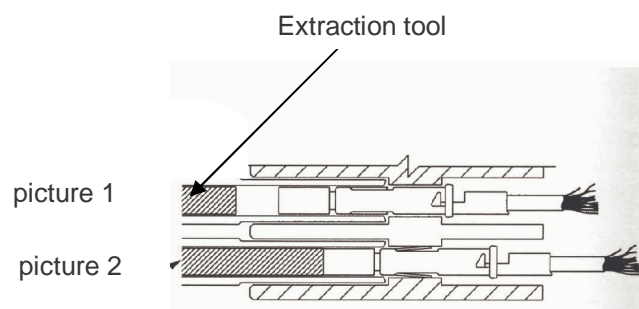

Bearbeitet:
AKU / WD

Geprüft:
NK

Norm:
HES

Änd.-Stand:
-4263W

Änd.-Datum:
11.06.2012



ITT Industries

Assembly instruction

APD 6-/7-way

CAS25022E**II.) Assembly instruction with Press-in Contacts (pin contacts only)**

In addition to the standard contacts also press-in contacts may be used for the APD 6-/ 7-way fixed connector. The pressed-in contacts cannot be exchanged anymore.

1.) Connector Types

Fixed connector
Flange receptacle

Packaging unit: 100 pieces

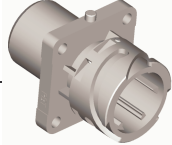
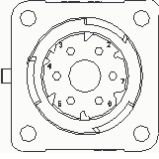
		Bestell-Nr.	Bestell-Bez.	Code	Farbe	
	6-way		120110-0020	APD-1AP6-EP	1	black (1. contact cavity closed)
	7-way		121583-0205	APD-1AP7-EP	1	black

Fixed connector
Jam nut receptacle

Packaging unit: 100 pieces

		Bestell-Nr.	Bestell-Bez.	Code	Farbe	
	6-polig		Auf Anfrage	APD-1CP6-EP	1	black (1. contact cavity closed)
	7-polig		121583-0028	APD-1CP7-EP	1	black

2.) Press-In Contacts (1,6mm)

Order number:

330-8672-021 (tinned), (0,75-1,5mm²)330-8672-019 (tinned), (0,35-0,75mm²)

With plating, flash plated, on request

Packaging unit: 100 pieces

Bearbeitet:
AKU / WD

Geprüft:
NK

Norm:
HES

Änd.-Stand:
-4263W

Änd.-Datum:
11.06.2012



ITT Industries

Assembly instruction

APD 6-/7-way

CAS25022E**3.) Stripping the Cable**

Hand crimp tool



The crimping process occurs with a hand crimp tool:
 tool M22520-1-01
 locator CT 120090-163

The crimp adjustment should be read of
 and adjusted at the locator.

Pin contact 330-8672-021 330-8672-019	} —	Hand crimp tool	Order no.:
		M22520-1-01	995-0001-585
		Locator for hand crimp tool	
		CT120090-163	120090-0163

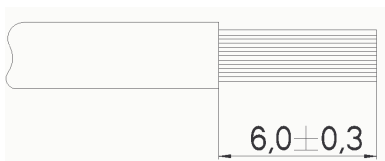
4.) Crimp instruction for Press-in Contacts

The stripping length for the press-in contact is 6,0+/-
 0,3mm. Strip it with the proper stripping clamp or
 stripping machine.

The stranded wires must not be damaged during this
 process.

- 1.) Strip to the proper length
- 2.) Add the right locator (turret) to the hand crimp tool
- 3.) Adjust the crimp diameter with the rotatable scale (see note Turret)
4. Place the contact in the locator and insert the stripped cable into the contact
- 5.) Press the clamp until reopening is possible
- 6.) Remove and check the contact crimp. Check the accurate position of the stranded wires through the visual holes.

Bearbeitet:
AKU / WD

Geprüft:
NK

Norm:
HES

Änd.-Stand:
-4263W

Änd.-Datum:
11.06.2012

Crimp error

All right!

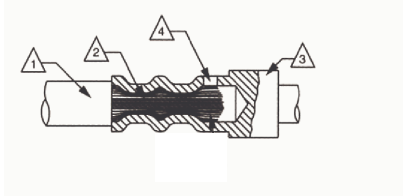

- △1 Cable insulation
- △2 Stranded wire
- △3 Contact
- △4 Visual hole

Wrong

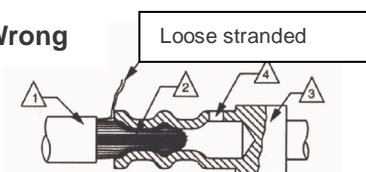

The minimum retention force are fixed in the standard DIN EN 60352-2-2006
These depend to consider on the cable diameter.

5.) Insertion of Press-in Contacts

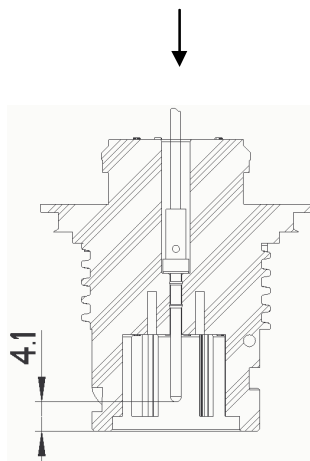

After having crimped, the press-in contact gets inserted into the insulator from the cable face (contact cavity). With the insertion tool CIT-APD-16 TIP that is integrated in the hand gear press, the press-in contact gets pressed-in until catch (control measurement 4,1mm).

The insertion tool has to press on the shoulder of the contact during process

<u>Order name:</u>	<u>Order umber:</u>
Hand gear press	
CHPZ-240	121586-0081
Insertion tool	
CIT-APD-16 TIP	317-8648-008

Bearbeitet:
AKU / WD

Geprüft:
NK

Norm:
HES

Änd.-Stand:
-4263W

Änd.-Datum:
11.06.2012



ITT Industries

Assembly instruction

APD 6-/7-way

CAS25022E

III.) Mounting Cut-out and Accessory

1.) Mounting Cut-out

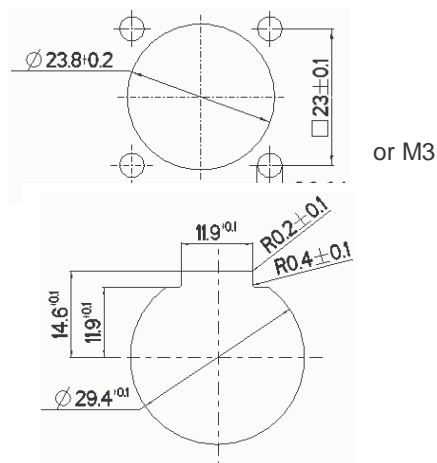

Mounting cut-out for all APD 6-/7-way fixed connectors, Flange receptacles. The thread in the bulkhead conforms with the max. torque for M3 screws.

Mounting cut-out for all APD 6-/7-way fixed connectors, Jam nut receptacle.

2.) Flange Sealing

Order number.: 075-8503-000

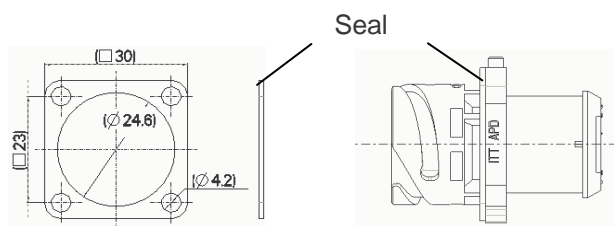

Rear panel mounting

Flange sealing, rubber, for sealing the flange receptacle.

The sealing gets mounted from the mating face.

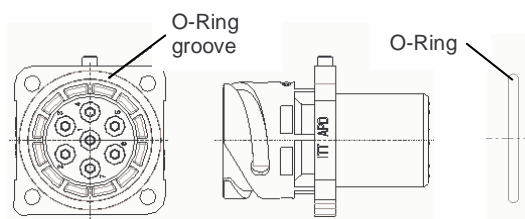

Front panel mounting

An O-Ring is used for front panel mounting.

Inappropriate for 121583-0020 APD-1AP7 (for Trident contacts).

3.) Metal Flange Support

Order number.: 066-8516-005

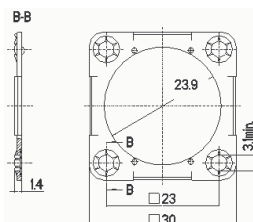

Flange support for all fixed connectors, flange receptacles. The flange gets inserted from the mating face with its plane surface (rear panel) pressing the flange of the receptacle (front panel mounting).

Bearbeitet:
AKU / WD

Geprüft:
NK

Norm:
HES

Änd.-Stand:
-4263W

Änd.-Datum:
11.06.2012

4.) Blanking Plug (Blind seal, wire filler)

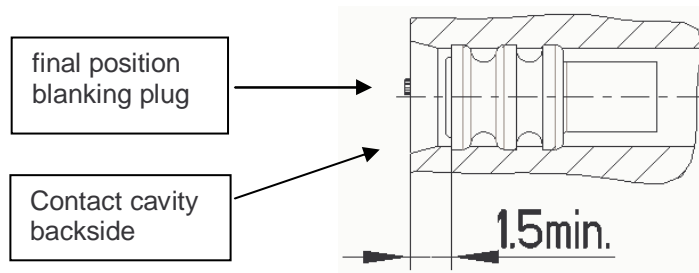

For empty contact cavities, there are blanking plugs for sealing. Insert the blanking plug as shown in the draft final position.

Order name: **Order number:**
10WH3940 121667-0025

5.) Mounting of Jam Nut Receptacle

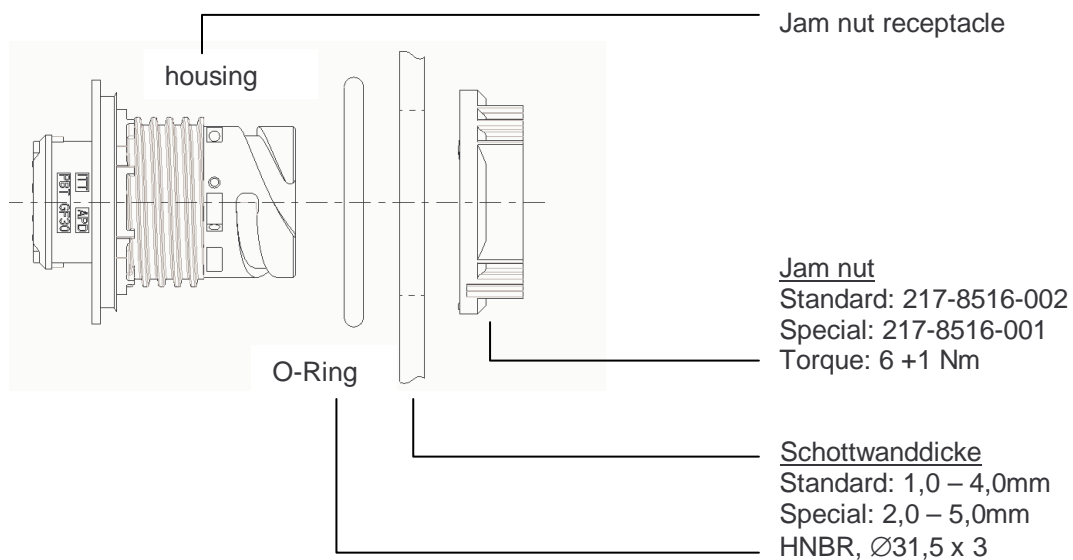

Bearbeitet:
AKU / WD

Geprüft:
NK

Norm:
HES

Änd.-Stand:
-4263W

Änd.-Datum:
11.06.2012



6.) Tools for Tighten the Jam Nut

Order number: 317-8649-034

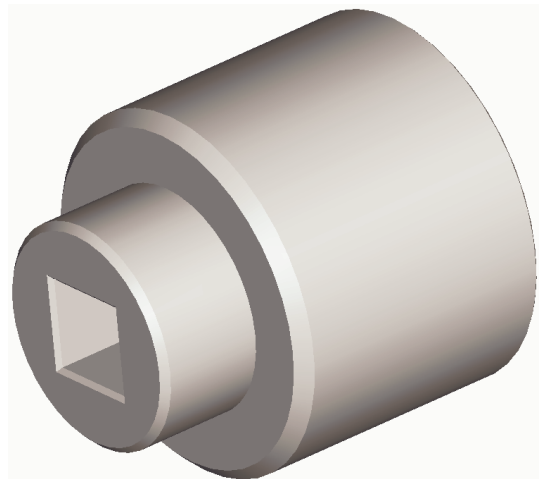
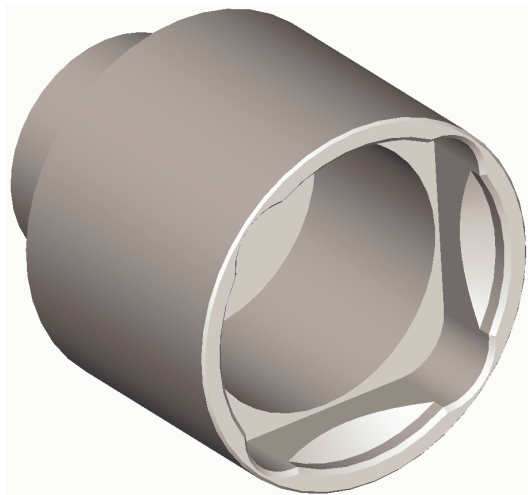

Bearbeitet:
AKU / WD

Geprüft:
NK

Norm:
HES

Änd.-Stand:
-4263W

Änd.-Datum:
11.06.2012



ITT Industries

Assembly instruction

APD 6-/7-way

CAS25022E**IV.) Product safety and warranty**

THIS NOTE MUST BE READ IN CONJUNCTION WITH THE PRODUCT DATA SHEET/CATALOG.

Failure to observe the advice in this information sheet and the operating conditions specified in the Product Data Sheet/Catalog could result in hazardous situations.

MATERIAL CONTENT AND PHYSICAL FORM

Electrical connectors do not usually contain hazardous materials. They contain conducting and non-conducting materials and can be divided into two groups.

- a) Printed circuit types and low cost audio types which employ all plastic insulators and casings.
- b) Rugged, Fire Barrier and High Reliability types with metal casings and either natural rubber, synthetic rubber, plastic or glass insulating materials. Contact materials vary with type of connector and also application and are usually manufactured from either: Copper, copper alloys, nickel, alumel, chromel or steel. In special applications, other alloys may be specified.

FIRE CHARACTERISTICS AND ELECTRIC SHOCK HAZARD

There is no fire hazard when the connector is correctly wired and used within the specified parameters. Incorrect wiring or assembly of the connector or careless use of metal tools or conductive fluids, or transit damage to any of the component parts may cause electric shock or burns. Live circuits must not be broken by separating mated connectors as this may cause arcing, ionisation and burning. Heat dissipation is greater at maximum resistance in a circuit. Hot spots may occur when resistance is raised locally by damage, e.g. cracked or deformed contacts, broken strands of wire. Local overheating may also result from the use of the incorrect application tools or from poor quality soldering or slack screw terminals. Overheating may occur if the ratings in the product Data Sheet/Catalog are exceeded and can cause breakdown of insulation and hence electric shock.

If heating is allowed to continue it intensifies by further increasing the local resistance through loss of temper of spring contacts, formation of oxide film on contacts and wires and leakage currents through carbonisation of insulation and tracking paths.

Fire can then result in the presence of combustible materials and this may release noxious fumes. Overheating may not be visually apparent. Burns may result from touching overheated components.

HANDLING

Care must be taken to avoid damage to any component parts of electrical connectors during installation and use. Although there are normally no sharp edges, care must be taken when handling certain components to avoid injury to fingers.

Electrical connectors may be damaged in transit to the customers, and damage may result in creation of hazards. Products should therefore be examined prior to installation/use and rejected if found to be damaged.

DISPOSAL

Incineration of certain materials may release noxious or even toxic fumes.

APPLICATION

Connectors with exposed contacts should not be selected for use on the current supply side of an electrical circuit, because an electric shock could result from touching exposed contacts on an unmated connector. Voltages in excess of 30 V ac. or 42.5 V dc are potentially hazardous and care should be taken to ensure that such voltages cannot be transmitted in any way to exposed metal parts of the connector body. The connector and wiring should be checked, before making live, to have no damage to metal parts or insulators, no solder blobs, loose strands, conducting lubricants, swarf, or any other undesired conducting particles.

Insulation resistance should be checked to make certain that no low resistance joints or spurious conducting paths are existing between contacts and exposed metal parts of the connector body. Further, the contact resistance of the connectors should be measured within the electrical circuit in order to identify high resistances, which result in excessive connector heating.

Always use the correct application tools as specified in the Data Sheet/Catalogue. Do not permit untrained personnel to wire, assemble or tamper with connectors. For operation voltage please see appropriate national regulations.

IMPORTANT GENERAL INFORMATION

(i) Air and creepage paths/Operating voltage

The admissible operating voltages depend on the individual applications and the valid national and other applicable safety regulations.

Bearbeitet:
AKU / WD

Geprüft:
NK

Norm:
HES

Änd.-Stand:
-4263W

Änd.-Datum:
11.06.2012



ITT Industries

Assembly instruction

APD 6-/7-way

CAS25022E

For this reason the air and creepage path data are only reference values. Observe reduction of air and creepage paths due to PC board and/or harnessing.

(ii) Temperature

All information given are temperature limits.

The operation temperature depends on the individual application.

(iii) Other important information

ITT Industries continuously endeavours to improve their products. Therefore, ITT Industries products may deviate from the description, technical data and shape as shown in this catalog and data sheets.

(iv) Harnessing and Assembly Instructions

If applicable, our special harnessing and/or assembly instruction has to be adhered to.

This is provided on request.

ITT Industries Cannon GmbH
 Cannonstrasse 1
 D-71384 Weinstadt
 Tel. +49 (0) 7151 699-0
 Fax. +49 (0) 7151 699-217
 info@de.itt.com
 www.ittcannon.com

Bearbeitet:
AKU / WD

Geprüft:
NK

Norm:
HES

Änd.-Stand:
-4263W

Änd.-Datum:
11.06.2012