

LM4985 Boomer™ Audio Power Amplifier Series Stereo 135mW Low Noise Headphone Amplifier with Selectable Capacitively Coupled or Output Capacitor-less (OCL) Output and Digitally Controlled (I²C) Volume Control

Check for Samples: [LM4985](#), [LM4985TMEVAL](#)

FEATURES

- **OCL or Capacitively Coupled Outputs (Patent Pending)**
- **I²C Digitally Controlled Volume Control**
- **Available in Space-Saving 0.4mm Lead-Pitch DSBGA Package**
- **Volume Control Range: –76dB to +18dB**
- **Ultra Low Current Shutdown Mode**
- **2.3V - 5.5V Operation**
- **Ultra Low Noise**

APPLICATIONS

- **Mobile Phones**
- **PDAs**
- **Portable Electronics Devices**
- **MP3 Players**

KEY SPECIFICATIONS (V_{DD} = 3.6V)

- **PSRR: 217Hz and 1kHz**
 - **Output Capacitor-Less (OCL)**
 - **f_{RIPPLE} = 217Hz, 77dB (Typ)**
 - **f_{RIPPLE} = 1kHz, 76dB (Typ)**
 - **Capacitor Coupled (C-CUPL)**
 - **f_{RIPPLE} = 217Hz, 63dB (Typ)**
 - **f_{RIPPLE} = 1kHz, 62dB (Typ)**
- **Output Power Per Channel**
(f_{IN} = 1kHz, THD+N = 1%),
R_L = 16Ω, OCL
 - **V_{DD} = 2.5V, 31mW (Typ)**
 - **V_{DD} = 3.6V, 68mW (Typ)**
 - **V_{DD} = 5.0V, 135mW (Typ)**
- **THD+N (f = 1kHz)**
 - **R_{LOAD} = 16Ω, OCL, P_{OUT} = 60mW, 0.60**
 - **R_{LOAD} = 32Ω, OCL, P_{OUT} = 33mW, 0.031**
- **Shutdown Current, 0.1μA (Typ)**

DESCRIPTION

The LM4985 is a stereo audio power amplifier with internal digitally controlled volume control. This amplifier is capable of delivering 68mW_{RMS} per channel into a 16Ω load or 38mW_{RMS} per channel into a 32Ω load at 1% THD when powered by a 3.6V power supply and operating in the OCL mode.

Boomer audio power amplifiers were designed specifically to provide high quality output power with a minimal amount of external components. To that end, the LM4985 features two functions that optimize system cost and minimize PCB area: an integrated, digitally controlled (I²C bus) volume control and an operational mode that eliminates output signal coupling capacitors (OCL mode). Since the LM4985 does not require bootstrap capacitors, snubber networks, or output coupling capacitors, it is optimally suited for low-power, battery powered portable systems. For added design flexibility, the LM4985 can also be configured for single-ended capacitively coupled outputs.

The LM4985 features a current shutdown mode for micropower dissipation and thermal shutdown protection.



Please be aware that an important notice concerning availability, standard warranty, and use in critical applications of Texas Instruments semiconductor products and disclaimers thereto appears at the end of this data sheet.

Boomer is a trademark of Texas Instruments.

All other trademarks are the property of their respective owners.

Block Diagram

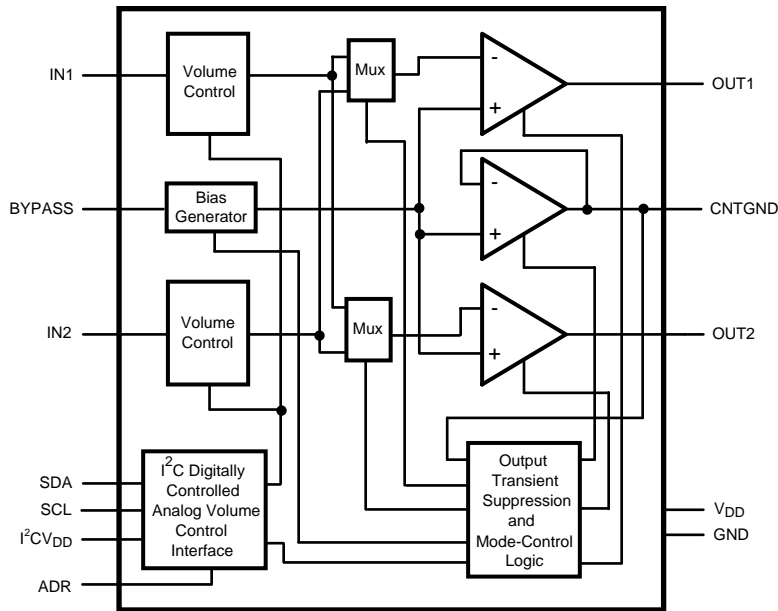

Figure 1. Block Diagram

Typical Application

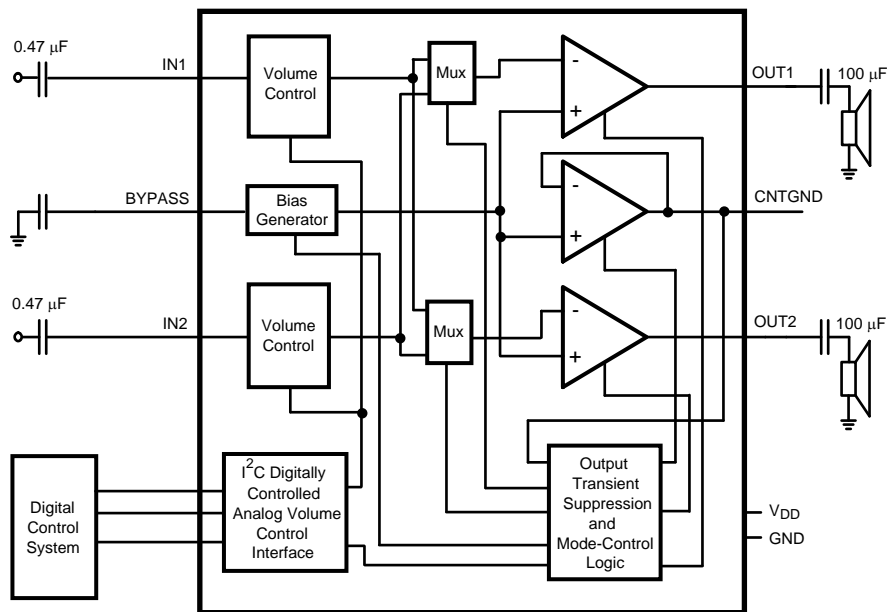

Figure 2. Typical Capacitively Coupled Output Configuration Circuit

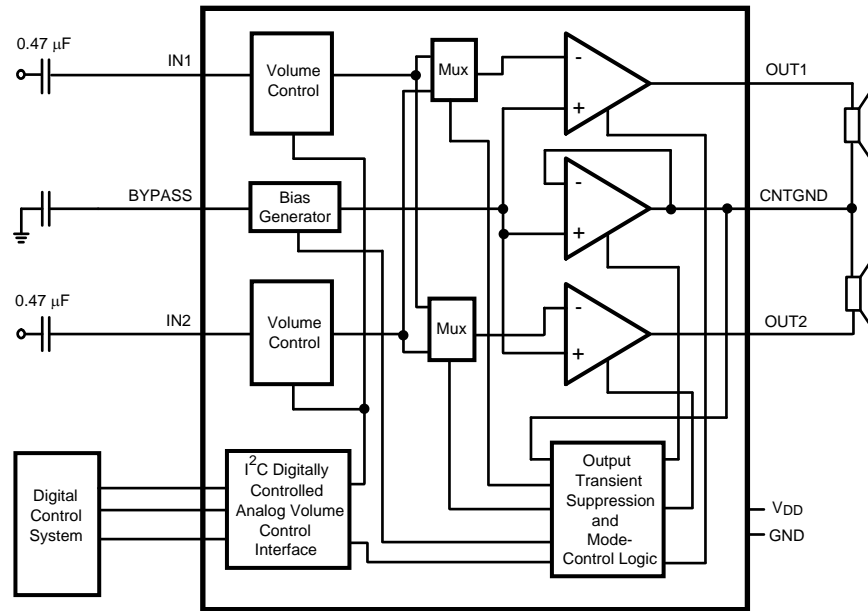

Figure 3. Typical OCL Output Configuration Circuit

Connection Diagram

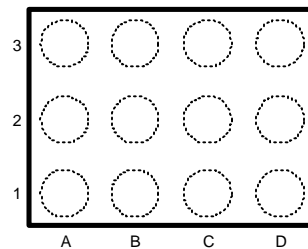

Figure 4. DSBGA Package
Top View
See NS Package Number YFQ0012

PIN REFERENCE, NAME, AND FUNCTION

Reference	Name	Function
A1	ADR	I ² C serial interface address input.
A2	IN2	Analog signal input two.
A3	OUT2	Power amplifier two output.
B1	SDA	I ² C serial interface data input.
B2	BYPASS	The internal V _{DD} /2 ac bypass node.
B3	CNTGND	In OCL mode, this is the ac ground return. It is biased to V _{DD} /2. Leave unconnected for C-CUPL mode.
C1	SCL	I ² C serial interface clock input.
C2	GND	The LM4985's power supply ground input.
C3	V _{DD}	The LM4985's power supply voltage input.
D1	I ² CV _{DD}	I ² C serial interface power supply input. Can be connected to the same supply that is connected to the V _{DD} pin.
D2	IN1	Analog signal input one.
D3	OUT1	Power amplifier one output.



These devices have limited built-in ESD protection. The leads should be shorted together or the device placed in conductive foam during storage or handling to prevent electrostatic damage to the MOS gates.

Absolute Maximum Ratings⁽¹⁾⁽²⁾

Supply Voltage (V_{DD} , I^2CV_{DD})		6.0V
Storage Temperature		-65°C to +150°C
Input Voltage (IN1, IN2, OUT1, OUT2, BYPASS, CNTGND, GND pins relative to the V_{DD} pin)		-0.3V to $V_{DD} + 0.3V$
Input Voltage (ADR, SDA, SCL pins, relative to the I^2CV_{DD} pin)		-0.3V to $I^2CV_{DD} + 0.3V$
Power Dissipation ⁽³⁾		Internally Limited
ESD Susceptibility ⁽⁴⁾		2000V
ESD Susceptibility ⁽⁵⁾		200V
Junction Temperature		150°C
Thermal Resistance	θ_{JA}	109°C/W

- (1) All voltages are measured with respect to the GND pin unless otherwise specified.
- (2) Absolute Maximum Ratings indicate limits beyond which damage to the device may occur. Operating Ratings indicate conditions for which the device is functional but do not ensure specific performance limits. Electrical Characteristics state DC and AC electrical specifications under particular test conditions which ensure specific performance limits. This assumes that the device is within the Operating Ratings. Specifications are not ensured for parameters where no limit is given, however, the typical value is a good indication of device performance.
- (3) The maximum power dissipation must be derated at elevated temperatures and is dictated by T_{JMAX} , θ_{JA} , and the ambient temperature, T_A . The maximum allowable power dissipation is $P_{DMAX} = (T_{JMAX} - T_A) / \theta_{JA}$ or the number given in Absolute Maximum Ratings, whichever is lower. For the LM4985, see power derating currents for more information.
- (4) Human Body Model: 100pF discharged through a 1.5k Ω resistor.
- (5) Machine Model: 200pF $\leq C_{mm} \leq 220$ pF discharged through all pins.

Operating Ratings

Temperature Range	$T_{MIN} \leq T_A \leq T_{MAX}$	-40°C $\leq T_A \leq$ 85°C
Supply Voltage	V_{DD}	2.3V $\leq V_{CC} \leq$ 5.5V
	I^2CV_{DD}	1.7V $\leq I^2CV_{DD} \leq$ 5.5V

Electrical Characteristics $V_{DD} = 5V$ ⁽¹⁾⁽²⁾

The following specifications apply for $R_L = 16\Omega$, $f = 1kHz$, and $C_B = 4.7\mu F$ unless otherwise specified. Limits apply to $T_A = 25^\circ C$.

Symbol	Parameter	Conditions	LM4985		Units (Limits)
			Typ ⁽³⁾	Limit ⁽⁴⁾⁽⁵⁾	
I_{DD}	Quiescent Power Supply Current	$V_{IN} = 0V$, $I_{OUT} = 0A$			mA (max)
		Single-Channel no load OCL	2		
		Single-Channel no load C-CUPL	1.5		
		Dual-Channel no load OCL	3	4.9	
		Dual-Channel no load C-CUPL	2.3	3.8	
I_{SD}	Shutdown Current	$V_{SHUTDOWN} = GND$	0.1	1.0	μA (max)
V_{SDIH}	Logic Voltage Input High			3.5	V (min)
V_{SDIL}	Logic Voltage Input Low			1.5	V (max)

- (1) All voltages are measured with respect to the GND pin unless otherwise specified.
- (2) Absolute Maximum Ratings indicate limits beyond which damage to the device may occur. Operating Ratings indicate conditions for which the device is functional but do not ensure specific performance limits. Electrical Characteristics state DC and AC electrical specifications under particular test conditions which ensure specific performance limits. This assumes that the device is within the Operating Ratings. Specifications are not ensured for parameters where no limit is given, however, the typical value is a good indication of device performance.
- (3) Typicals are measured at 25°C and represent the parametric norm.
- (4) Limits are specified to Texas Instruments' AOQL (Average Outgoing Quality Level).
- (5) Datasheet min/max specification limits are specified by design, test, or statistical analysis.

Electrical Characteristics $V_{DD} = 5V^{(1)(2)}$ (continued)

The following specifications apply for $R_L = 16\Omega$, $f = 1\text{kHz}$, and $C_B = 4.7\mu\text{F}$ unless otherwise specified. Limits apply to $T_A = 25^\circ\text{C}$.

Symbol	Parameter	Conditions	LM4985		Units (Limits)
			Typ ⁽³⁾	Limit ⁽⁴⁾⁽⁵⁾	
P_O	Output Power	THD $\leq 1\%$; $f_{IN} = 1\text{kHz}$			
		$R_{LOAD} = 16\Omega$ OCL	135	115	
		$R_{LOAD} = 16\Omega$ C-CUPL	135		mW (min)
		$R_{LOAD} = 32\Omega$ OCL	79	70	
		$R_{LOAD} = 32\Omega$ C-CUPL	80		
THD+N	Total Harmonic Distortion + Noise	$R_{LOAD} = 16\Omega$ OCL, $P_O = 100\text{mW}$ $R_{LOAD} = 16\Omega$ C-CUPL, $P_O = 100\text{mW}$ $R_{LOAD} = 32\Omega$ OCL, $P_O = 60\text{mW}$ $R_{LOAD} = 32\Omega$ C-CUPL, $P_O = 70\text{mW}$	0.08 0.02 0.04 0.01		%
V_{ON}	Output Noise Voltage	$V_{IN} = \text{AC GND}$, $A_V = 0\text{dB}$, A-weighted	15		μV
PSRR	Power Supply Rejection Ratio	$V_{RIPPLE} = 200\text{mVp-p}^{(6)}$ $f_{IN} = 217\text{Hz}$ sinewave OCL C-CUPL	77 65	57	dB (min)
		$f_{IN} = 1\text{kHz}$ sinewave OCL C-CUPL	77 65	60	
Xtalk	Channel-to-channel Crosstalk	$P_{out} = 40\text{mW}$. OCL $R_{LOAD} = 16\Omega$ $R_{LOAD} = 32\Omega$	51 56		dB
		$P_{out} = 50\text{mW}$. C-CUPL $R_{LOAD} = 16\Omega$ $R_{LOAD} = 32\Omega$	58 68		dB
T_{WU}	Wake Up Time form Shutdown	$C_{BYPASS} = 4.7\mu\text{F}^{(7)}$ $WT1 = 0$, $WT0 = 0$ OCL C-CUPL	75 285		msec
		$WT1 = 0$, $WT0 = 1$ OCL C-CUPL	110 530		
		$WT1 = 1$, $WT0 = 0$ OCL C-CUPL	180 1030		
		$WT1 = 1$, $WT0 = 1$ OCL C-CUPL	320 2050		
R_{IN}	Input Resistance	Stereo mode Mono mode	20 10		k Ω
A_{VMIN}	Minimum Gain	Code = 00000	-76		dB (min)
A_{VMAX}	Maximum Gain	Code = 11111	18		dB (min)
ΔA_V	Gain Accuracy per Step	$18\text{dB} \geq A_V \geq -44\text{dB}$ $-44\text{dB} \geq A_V > -76\text{dB}$	± 0.5 ± 1.0		dB
V_{OS}	Output Offset Voltage	OCL $R_{LOAD} = 32\Omega$ $V_{IN} = \text{AC GND}$	2.0	20	mV (max)

(6) 10 Ω terminated input.

(7) The wake-up time (T_{WU}) is calculated using the following formula; $T_{WU} = [C_{BYPASS} (V_{DD}) / 2 (I_{BYPASS})] + 40\text{ms}$.

Electrical Characteristics $V_{DD} = 3.6V^{(1)(2)}$

The following specifications apply for $R_L = 16\Omega$, $f = 1kHz$, and $C_B = 4.7\mu F$ unless otherwise specified. Limits apply to $T_A = 25^\circ C$.

Symbol	Parameter	Conditions	LM4985		Units (Limits)
			Typ ⁽³⁾	Limit ⁽⁴⁾⁽⁵⁾	
I_{DD}	Quiescent Power Supply Current	$V_{IN} = 0V, I_{OUT} = 0A$			mA (max)
		Single-Channel no load OCL	1.8	3.1	
		Single-Channel no load C-CUPL	1.0		
		Dual-Channel no load OCL	2.1	4	
		Dual-Channel no load C-CUPL	2.3	3	
I_{SD}	Shutdown Current	$V_{SHUTDOWN} = GND$	0.1	1.0	μA (max)
V_{SDIH}	Logic Voltage Input High			2.52	V (min)
V_{SDIL}	Logic Voltage Input Low			1.08	V (max)
P_O	Output Power	THD+N < 1%, $f_{IN} = 1kHz$			mW (min)
		$R_{LOAD} = 16\Omega$ OCL	68	60	
		$R_{LOAD} = 16\Omega$ C-CUPL	70		
		$R_{LOAD} = 32\Omega$ OCL	38	34	
		$R_{LOAD} = 32\Omega$ C-CUPL	41		
THD+N	Total Harmonic Distortion + Noise	$R_{LOAD} = 16\Omega$ OCL, $P_O = 60mW$	0.06		%
		$R_{LOAD} = 16\Omega$ C-CUPL, $P_O = 60mW$	0.03		
		$R_{LOAD} = 32\Omega$ OCL, $P_O = 33mW$	0.03		
		$R_{LOAD} = 32\Omega$ C-CUPL, $P_O = 38mW$	0.03		
V_{ON}	Output Noise Voltage	$V_{IN} = AC$ GND, $A_V = 0dB$, A-weighted	15		μV
PSRR	Power Supply Rejection Ratio	$V_{RIPPLE} = 200mVp-p^{(6)}$ $f_{IN} = 217Hz$ sinewave OCL	77	55	dB (min)
		C-CUPL	63		
		$f_{IN} = 1kHz$ sinewave OCL	76	57	
		C-CUPL	62		
Xtalk	Channel-to-Channel Crosstalk	$P_{out} = 40mW$. OCL $R_{LOAD} = 16\Omega$ $R_{LOAD} = 32\Omega$	51 56		dB
		$P_{out} = 50mW$. C-CUPL $R_{LOAD} = 16\Omega$ $R_{LOAD} = 32\Omega$	58 69		

(1) All voltages are measured with respect to the GND pin unless otherwise specified.

(2) Absolute Maximum Ratings indicate limits beyond which damage to the device may occur. Operating Ratings indicate conditions for which the device is functional but do not ensure specific performance limits. Electrical Characteristics state DC and AC electrical specifications under particular test conditions which ensure specific performance limits. This assumes that the device is within the Operating Ratings. Specifications are not ensured for parameters where no limit is given, however, the typical value is a good indication of device performance.

(3) Typicals are measured at $25^\circ C$ and represent the parametric norm.

(4) Limits are specified to Texas Instruments' AOQL (Average Outgoing Quality Level).

(5) Datasheet min/max specification limits are specified by design, test, or statistical analysis.

(6) 10 Ω terminated input.

Electrical Characteristics $V_{DD} = 3.6V^{(1)(2)}$ (continued)

The following specifications apply for $R_L = 16\Omega$, $f = 1\text{kHz}$, and $C_B = 4.7\mu\text{F}$ unless otherwise specified. Limits apply to $T_A = 25^\circ\text{C}$.

Symbol	Parameter	Conditions	LM4985		Units (Limits)
			Typ ⁽³⁾	Limit ⁽⁴⁾⁽⁵⁾	
T_{WU}	Wake Up Time from Shutdown	$C_{BYPASS} = 4.7\mu\text{F}^{(7)}$			msec
		WT1 = 0, WT0 = 0 OCL C-CUPL	66 222	93	
		WT1 = 0, WT0 = 1 OCL C-CUPL	92 405		
		WT1 = 1, WT0 = 0 OCL C-CUPL	143 774		
		WT1 = 1, WT0 = 1 OCL C-CUPL	246 1532		
R_{IN}	Input Resistance	Stereo mode Mono mode	20 10		k Ω
A_{VMIN}	Minimum Gain	Code = 00000	-76	-72	dB (max)
A_{VMAX}	Maximum Gain	Code = 11111	18	17	dB (min)
ΔA_V	Gain Accuracy per Step	$18\text{dB} \geq A_V \geq -44\text{dB}$ $-44\text{dB} \geq A_V > -76\text{dB}$	± 0.5 ± 1.0	± 1.0 ± 2.0	dB
V_{OS}	Output Offset Voltage	OCL $R_{LOAD} = 32\Omega$ $V_{IN} = \text{AC GND}$	2.0	20	mV (max)

(7) The wake-up time (T_{WU}) is calculated using the following formula; $T_{WU} = [C_{BYPASS} (V_{DD}) / 2 (I_{BYPASS})] + 40\text{ms}$.

Electrical Characteristics $V_{DD} = 2.5V^{(1)(2)}$

The following specifications apply for $R_L = 16\Omega$, $f = 1\text{kHz}$, and $C_B = 4.7\mu\text{F}$ unless otherwise specified. Limits apply to $T_A = 25^\circ\text{C}$.

Symbol	Parameter	Conditions	LM4985		Units (Limits)
			Typ ⁽³⁾	Limit ⁽⁴⁾⁽⁵⁾	
I_{DD}	Quiescent Power Supply Current	$V_{IN} = 0V$, $I_{OUT} = 0A$ Single-Channel no load OCL Single-Channel no load C-CUPL Dual-Channel no load OCL Dual-Channel no load C-CUPL	1.6 1 2.1 1.6		mA
I_{SD}	Shutdown Current	$V_{SHUTDOWN} = \text{GND}$	0.1		μA
V_{SDIH}	Logic Voltage Input High			1.75	V (min)
V_{SDIL}	Logic Voltage Input Low			0.75	V (max)
P_O	Output Power	THD+N < 1%, $f_{IN} = 1\text{kHz}$ $R_{LOAD} = 16\Omega$ OCL $R_{LOAD} = 16\Omega$ C-CUPL $R_{LOAD} = 32\Omega$ OCL $R_{LOAD} = 32\Omega$ C-CUPL	31 33 19 19		mW

- (1) All voltages are measured with respect to the GND pin unless otherwise specified.
- (2) Absolute Maximum Ratings indicate limits beyond which damage to the device may occur. Operating Ratings indicate conditions for which the device is functional but do not ensure specific performance limits. Electrical Characteristics state DC and AC electrical specifications under particular test conditions which ensure specific performance limits. This assumes that the device is within the Operating Ratings. Specifications are not ensured for parameters where no limit is given, however, the typical value is a good indication of device performance.
- (3) Typicals are measured at 25°C and represent the parametric norm.
- (4) Limits are specified to Texas Instruments' AOQL (Average Outgoing Quality Level).
- (5) Datasheet min/max specification limits are specified by design, test, or statistical analysis.

Electrical Characteristics $V_{DD} = 2.5V^{(1)(2)}$ (continued)

The following specifications apply for $R_L = 16\Omega$, $f = 1kHz$, and $C_B = 4.7\mu F$ unless otherwise specified. Limits apply to $T_A = 25^\circ C$.

Symbol	Parameter	Conditions	LM4985		Units (Limits)
			Typ ⁽³⁾	Limit ⁽⁴⁾⁽⁵⁾	
THD+N	Total Harmonic Distortion + Noise	$R_{LOAD} = 16\Omega$ OCL, $P_O = 26mW$ $R_{LOAD} = 16\Omega$ C-CUPL, $P_O = 20mW$ $R_{LOAD} = 32\Omega$ OCL, $P_O = 16mW$ $R_{LOAD} = 32\Omega$ C-CUPL, $P_O = 15mW$	0.07 0.05 0.06 0.04		%
V_{ON}	Output Noise Voltage	$V_{IN} = AC$ GND, $A_V = 0dB$, A-weighted	10		μV
PSRR	Power Supply Rejection Ratio	$V_{RIPPLE} = 200mVp-p^{(6)}$ $f_{IN} = 217Hz$ sinewave OCL C-CUPL	75 59		dB
		$f_{IN} = 1kHz$ sinewave OCL C-CUPL	75 59		
Xtalk	Channel-to-Channel Crosstalk	$P_{out} = 20mW$, OCL $R_{LOAD} = 16\Omega$ $R_{LOAD} = 32\Omega$	50 55		dB
		$P_{out} = 20mW$, C-CUPL $R_{LOAD} = 16\Omega$ $R_{LOAD} = 32\Omega$	58 67		
T_{WU}	Wake Up Time from Shutdown	$C_{BYPASS} = 4.7\mu F^{(7)}$ $WT1 = 0$, $WT0 = 0$ OCL C-CUPL	66 214		msec
		$WT1 = 0$, $WT0 = 1$ OCL C-CUPL	92 544		
		$WT1 = 1$, $WT0 = 0$ OCL C-CUPL	145 1053		
		$WT1 = 1$, $WT0 = 1$ OCL C-CUPL	250 2098		
R_{IN}	Input Resistance	Stereo mode Mono mode	20 10		k Ω
A_{VMIN}	Minimum Gain	Code = 00000	-76		dB
A_{VMAX}	Maximum Gain	Code = 11111	18		dB
ΔA_V	Gain Accuracy per Step	$18dB \geq A_V \geq -44dB$ $-44dB \geq A_V > -76dB$	± 0.5 ± 1.0		dB
V_{OS}	Output Offset Voltage	OCL $R_{LOAD} = 32\Omega$ $V_{IN} = AC$ GND	2.0		mV

(6) 10 Ω terminated input.

(7) The wake-up time (T_{WU}) is calculated using the following formula; $T_{WU} = [C_{BYPASS} (VDD) / 2 (I_{BYPASS})] + 40ms$.

External Components Description

(See Figure 2)

Components	Functional Description
1. C_i	Input coupling capacitor which blocks the DC voltage at the amplifier's input terminals. Also creates a high-pass filter with R_i at $f_c = 1/(2\pi R_i C_i)$. Refer to the section Proper Selection of External Components , for an explanation of how to determine the value of C_i .
2. C_s	Supply bypass capacitor which provides power supply filtering. Refer to the POWER SUPPLY BYPASSING section for information concerning proper placement and selection of the supply bypass capacitor.

Components		Functional Description
3.	C_B	Bypass pin capacitor which provides half-supply filtering. Refer to the section, POWER SUPPLY BYPASSING , for information concerning proper placement and selection of C_B
6.	C_o	Output coupling capacitor which blocks the DC voltage at the amplifier's output. Forms a high pass filter with R_L at $f_o = 1/(2\pi R_L C_o)$

Typical Performance Characteristics

$T_A = 25^\circ\text{C}$, $A_V = 0\text{dB}$, $f_{IN} = 1\text{kHz}$ unless otherwise stated.

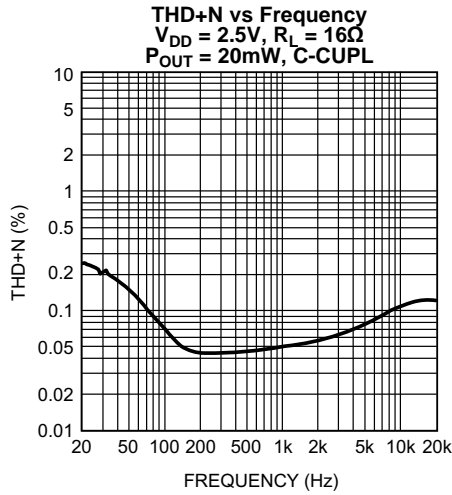

Figure 5.

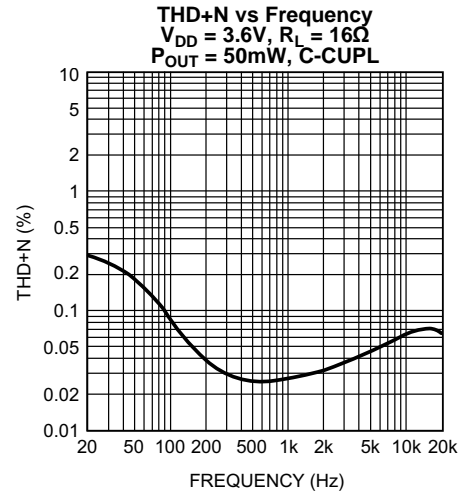

Figure 6.

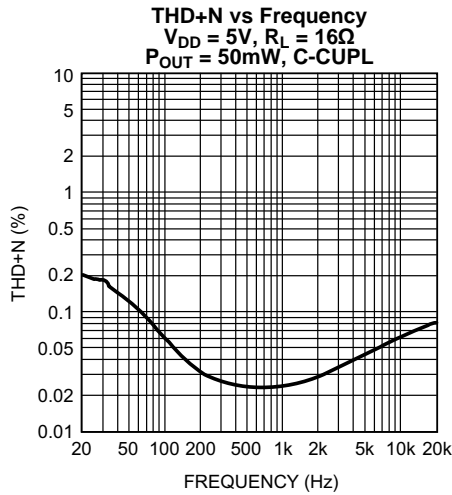

Figure 7.

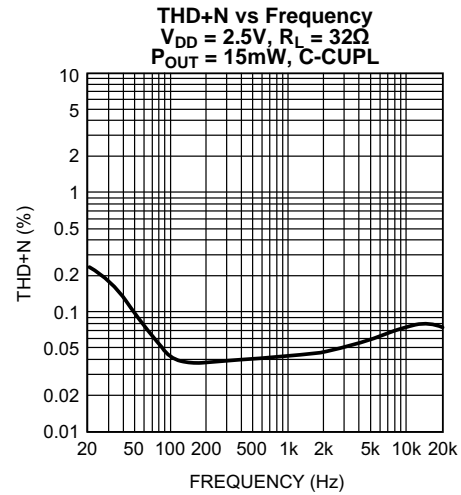

Figure 8.

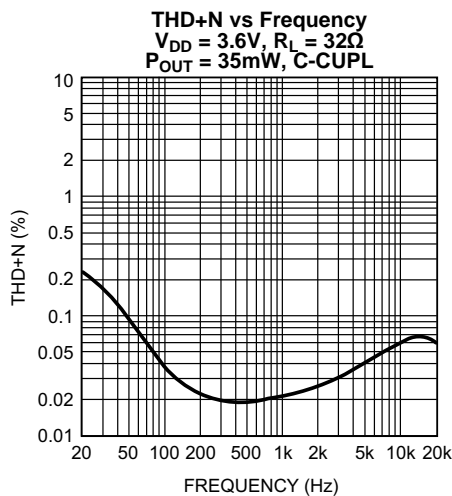

Figure 9.

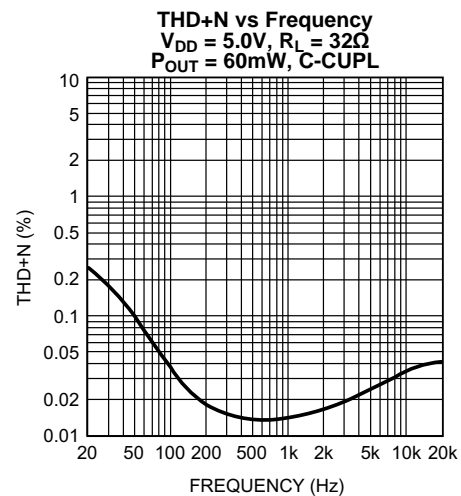

Figure 10.

Typical Performance Characteristics (continued)

T_A = 25°C, A_V = 0dB, f_{IN} = 1kHz unless otherwise stated.

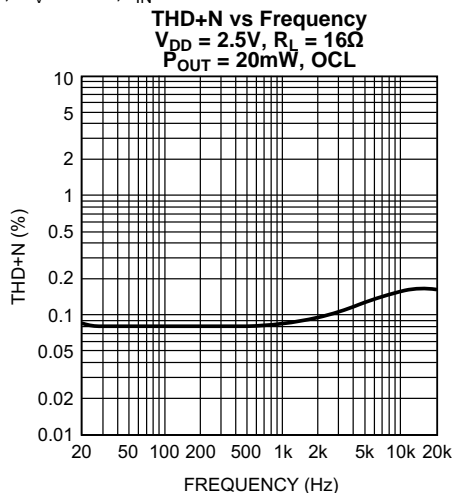

Figure 11.

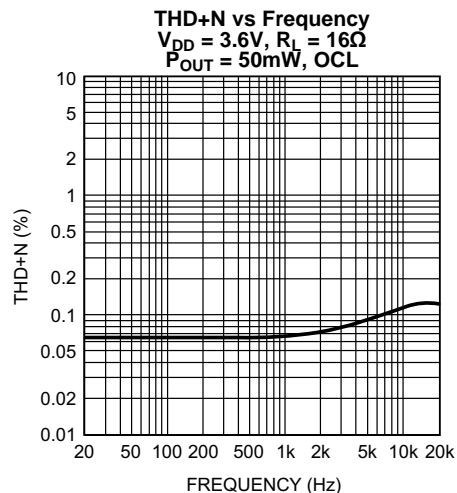

Figure 12.

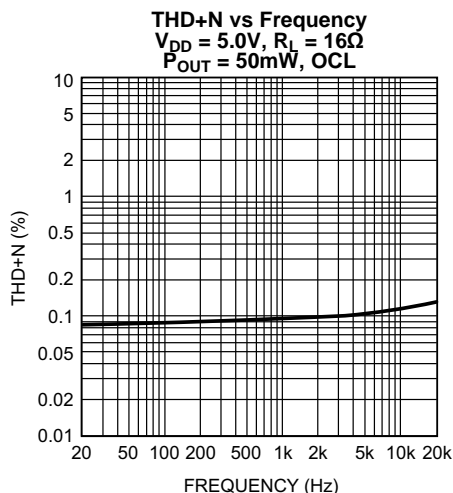

Figure 13.

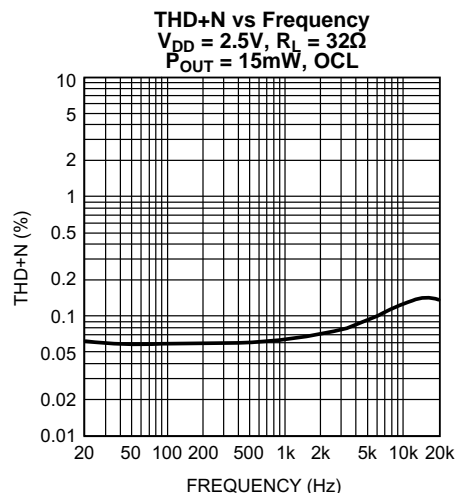

Figure 14.

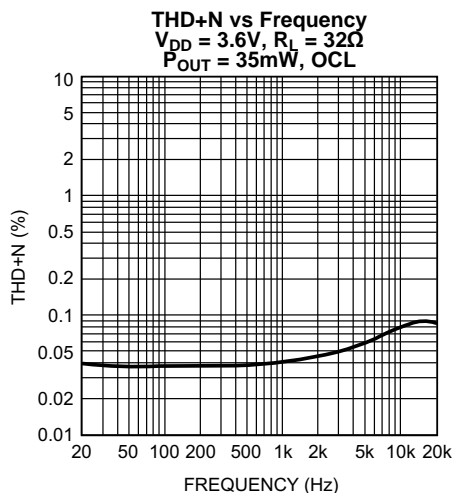

Figure 15.

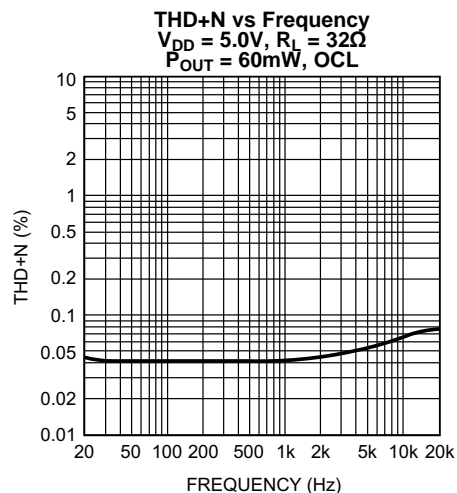

Figure 16.

Typical Performance Characteristics (continued)

$T_A = 25^\circ\text{C}$, $A_V = 0\text{dB}$, $f_{IN} = 1\text{kHz}$ unless otherwise stated.

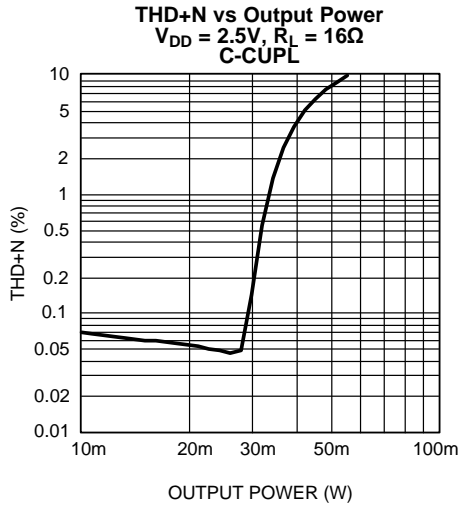

Figure 17.

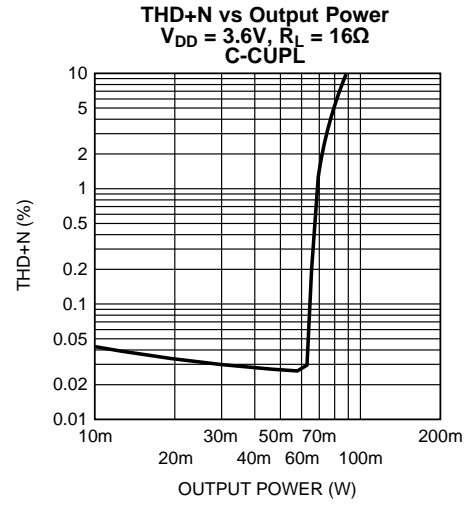

Figure 18.

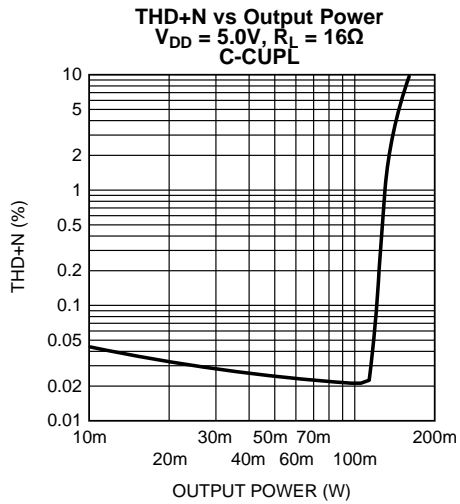

Figure 19.

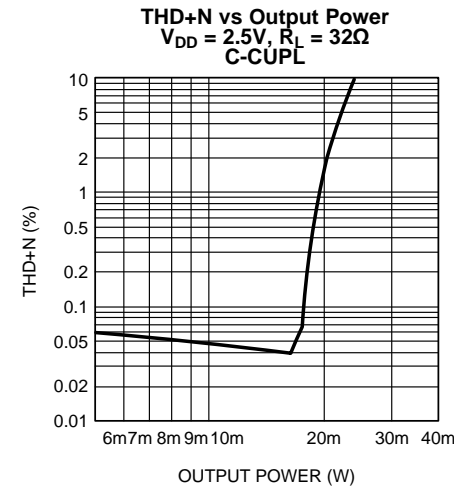

Figure 20.

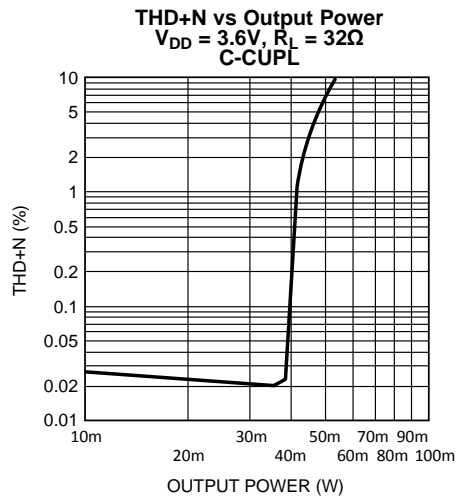

Figure 21.

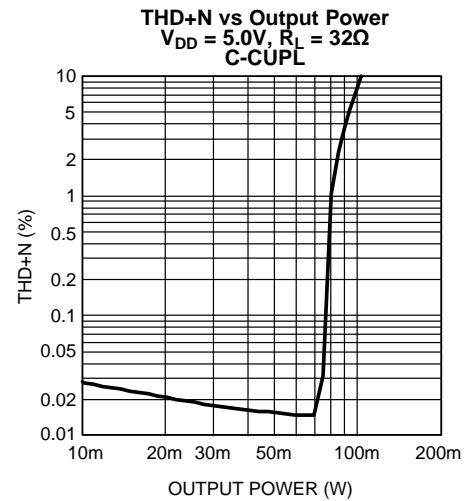

Figure 22.

Typical Performance Characteristics (continued)

T_A = 25°C, A_V = 0dB, f_{IN} = 1kHz unless otherwise stated.

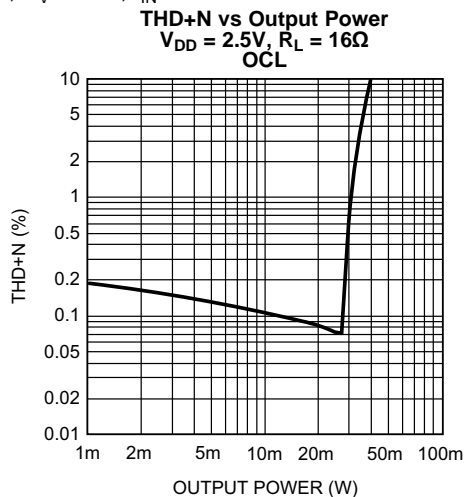

Figure 23.

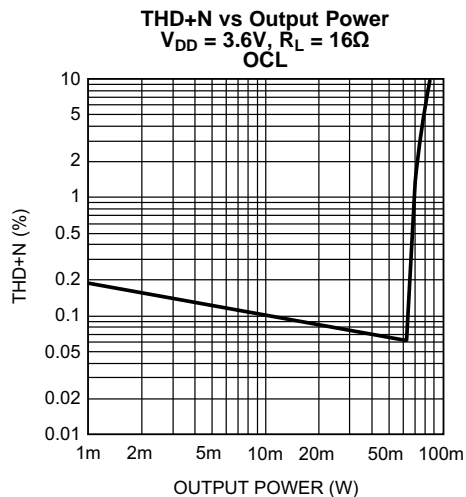

Figure 24.

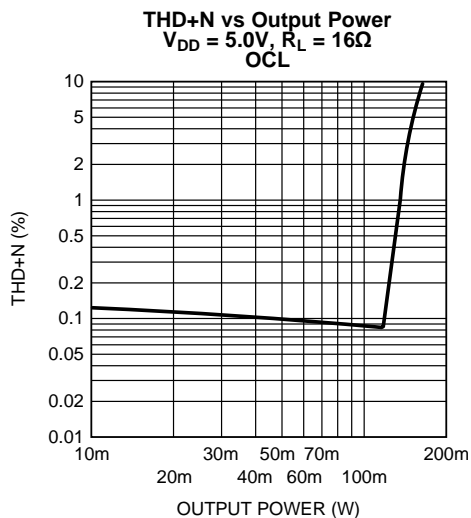

Figure 25.

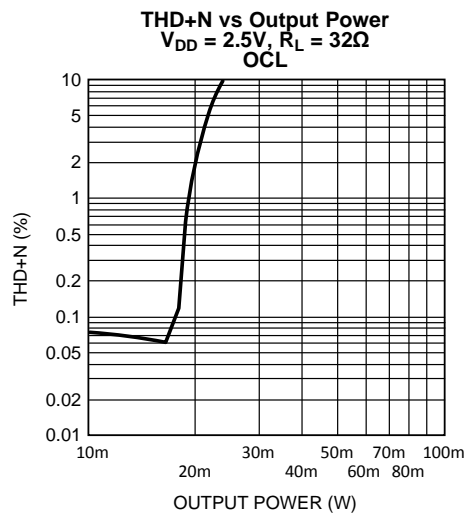

Figure 26.

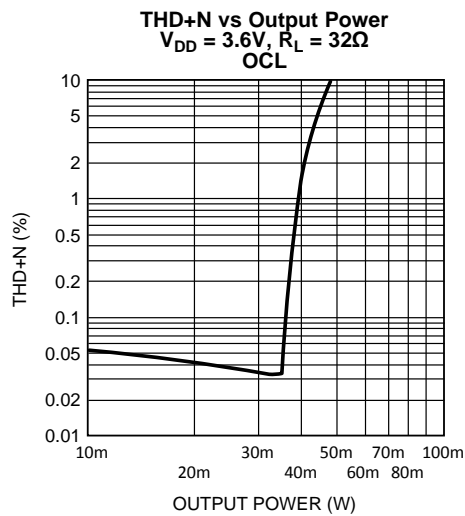

Figure 27.

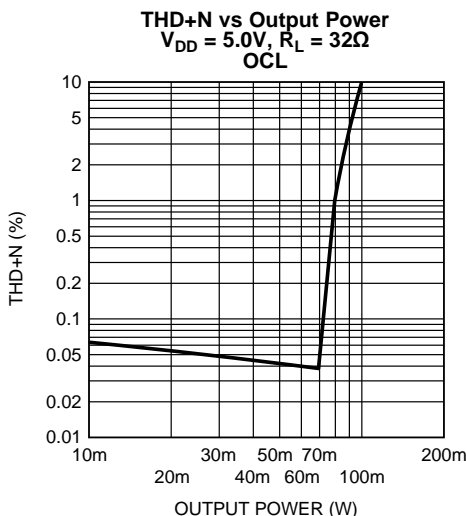

Figure 28.

Typical Performance Characteristics (continued)

$T_A = 25^\circ\text{C}$, $A_V = 0\text{dB}$, $f_{IN} = 1\text{kHz}$ unless otherwise stated.

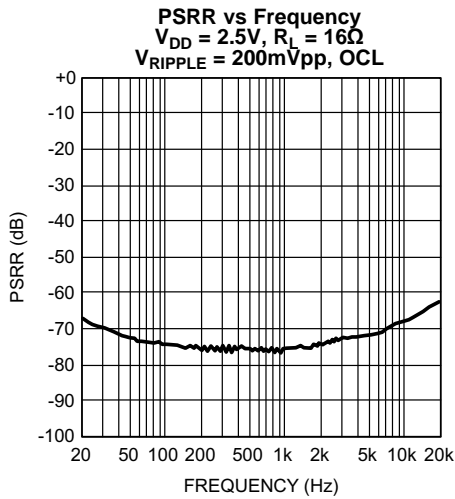

Figure 29.

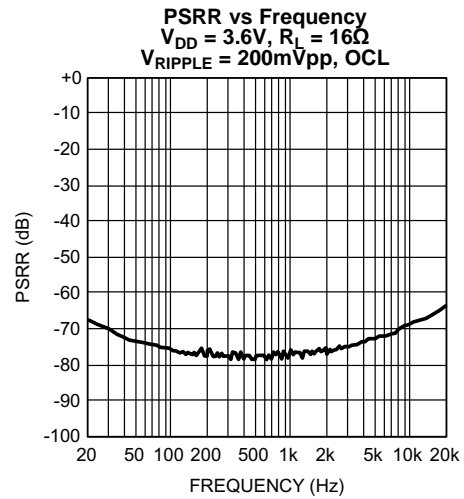

Figure 30.

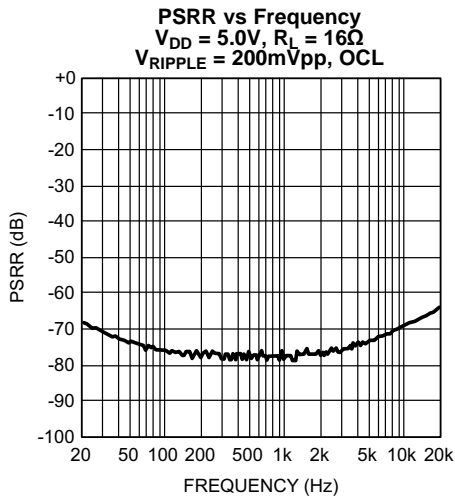

Figure 31.

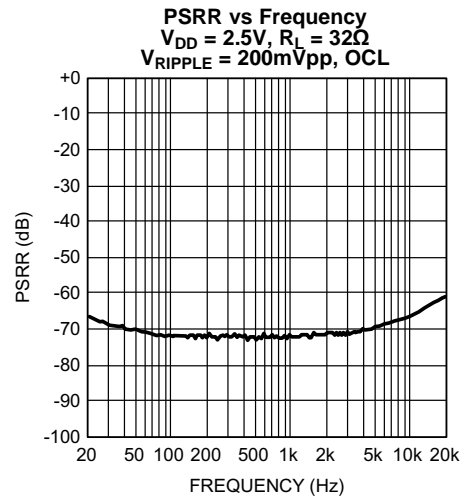

Figure 32.

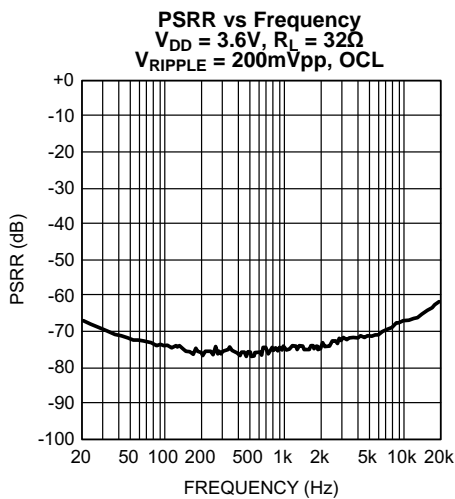

Figure 33.

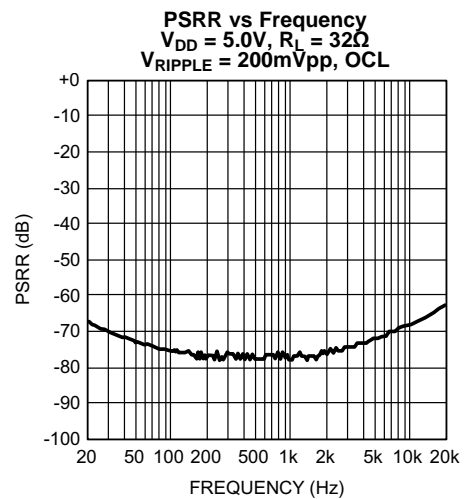

Figure 34.

Typical Performance Characteristics (continued)

T_A = 25°C, A_V = 0dB, f_{IN} = 1kHz unless otherwise stated.

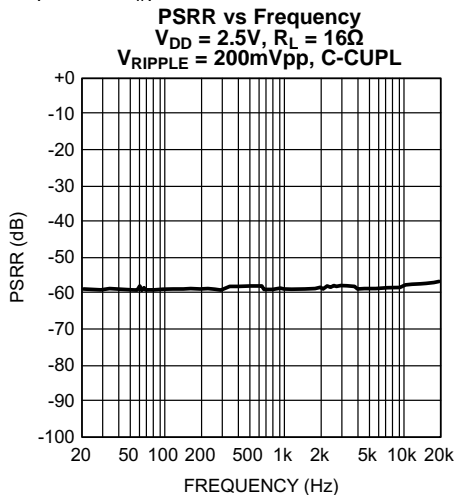

Figure 35.

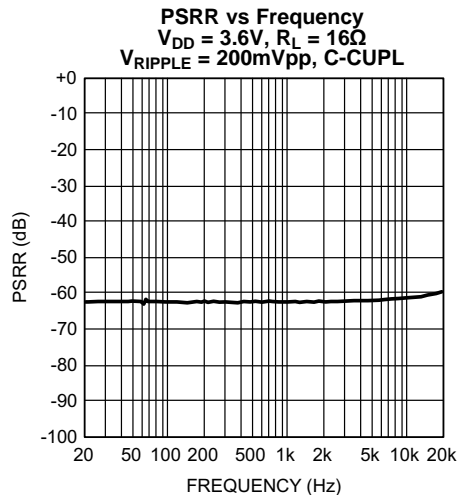

Figure 36.

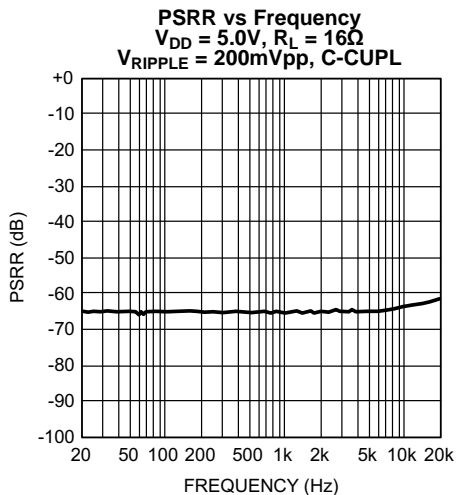

Figure 37.

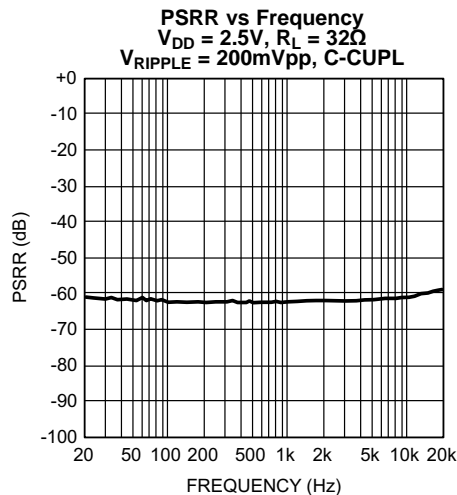

Figure 38.

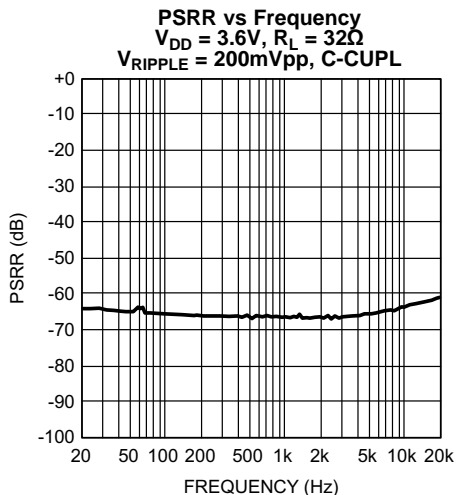

Figure 39.

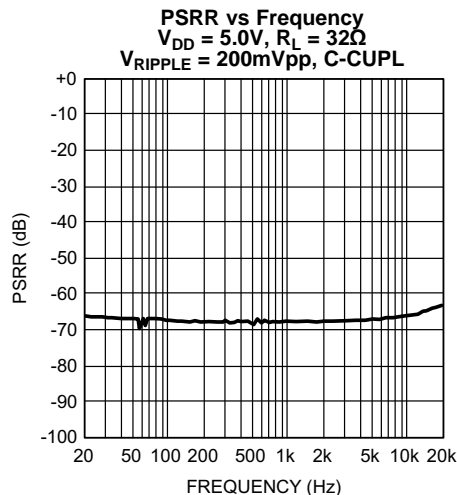
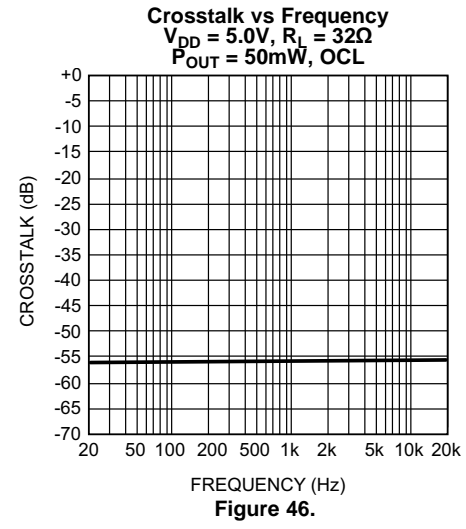
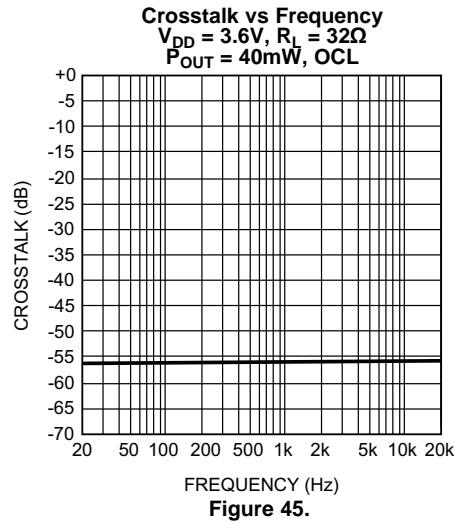
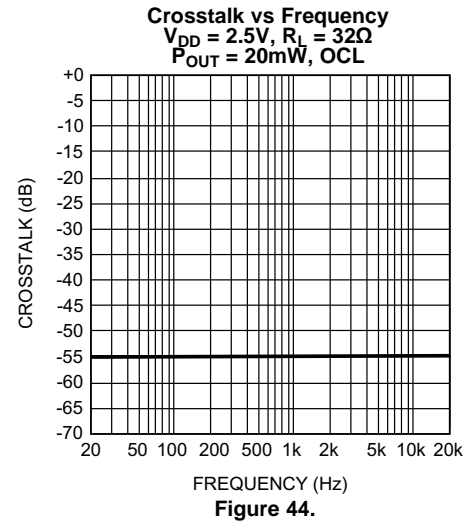
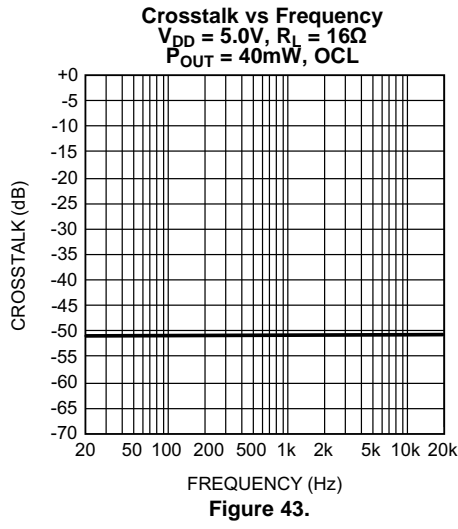
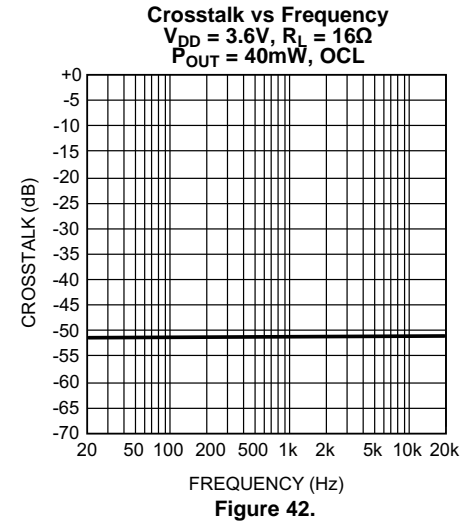
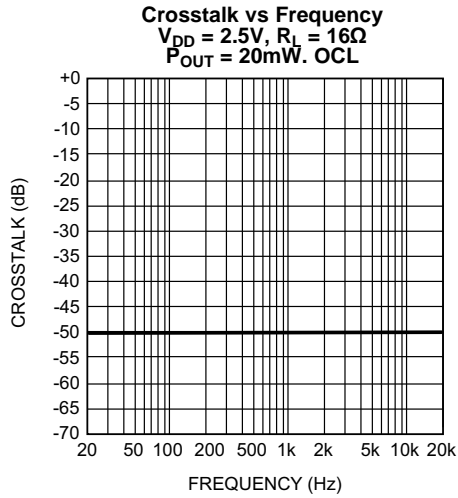

Figure 40.

Typical Performance Characteristics (continued)

$T_A = 25^\circ\text{C}$, $A_V = 0\text{dB}$, $f_{IN} = 1\text{kHz}$ unless otherwise stated.



Typical Performance Characteristics (continued)

$T_A = 25^\circ\text{C}$, $A_V = 0\text{dB}$, $f_{IN} = 1\text{kHz}$ unless otherwise stated.

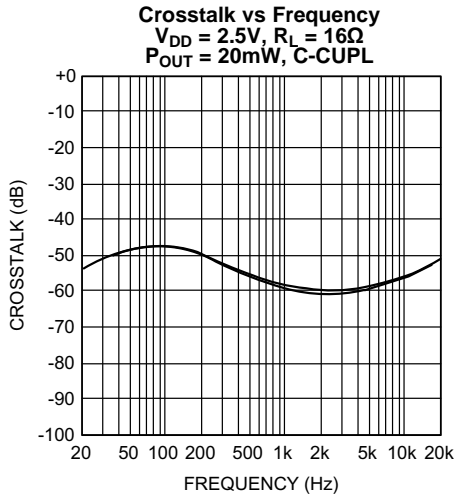

Figure 47.

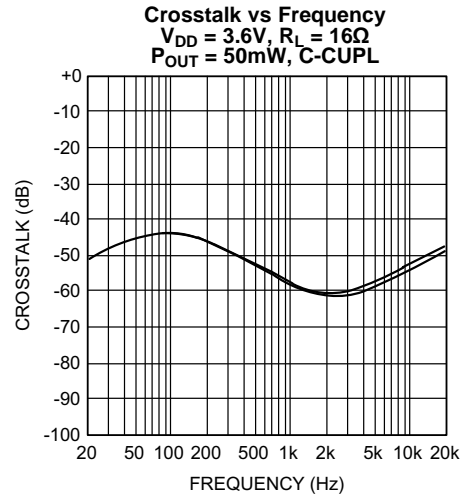

Figure 48.

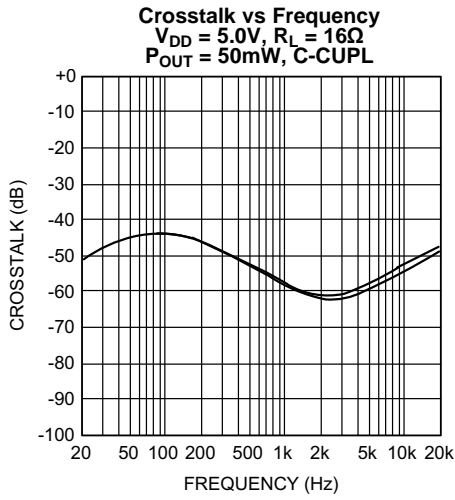

Figure 49.

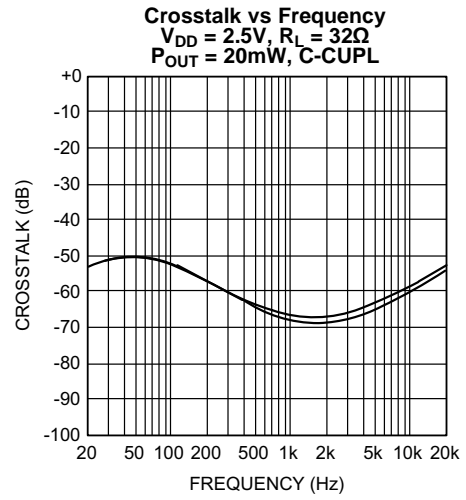

Figure 50.

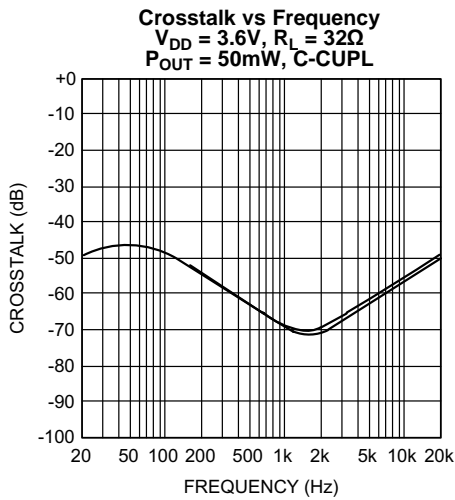

Figure 51.

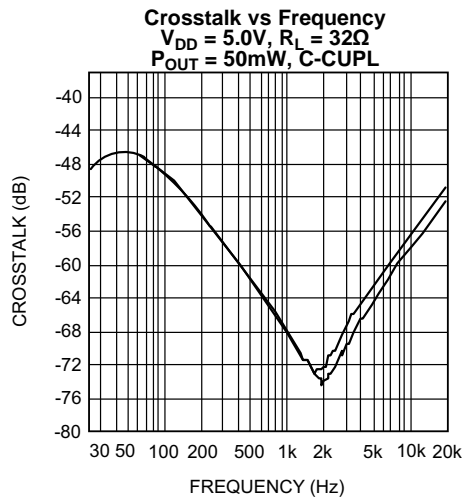

Figure 52.

Typical Performance Characteristics (continued)

$T_A = 25^\circ\text{C}$, $A_V = 0\text{dB}$, $f_{IN} = 1\text{kHz}$ unless otherwise stated.

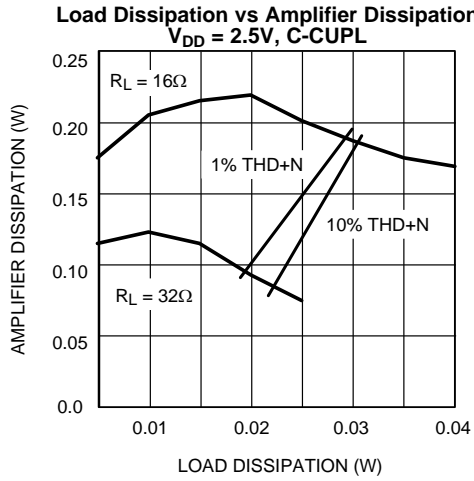

Figure 53.

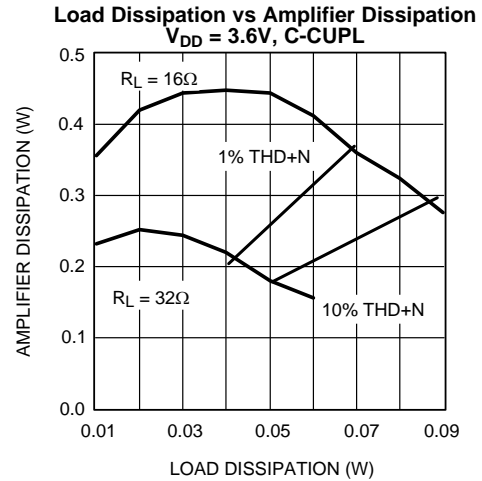

Figure 54.

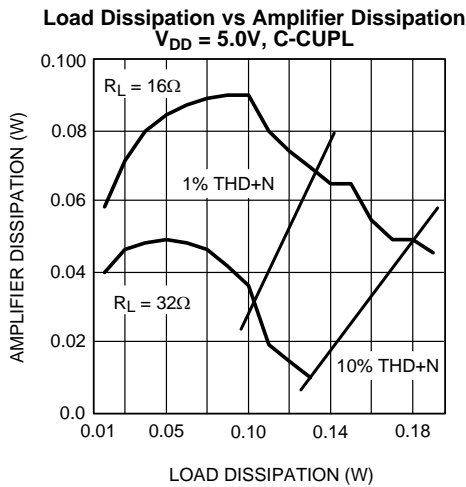

Figure 55.

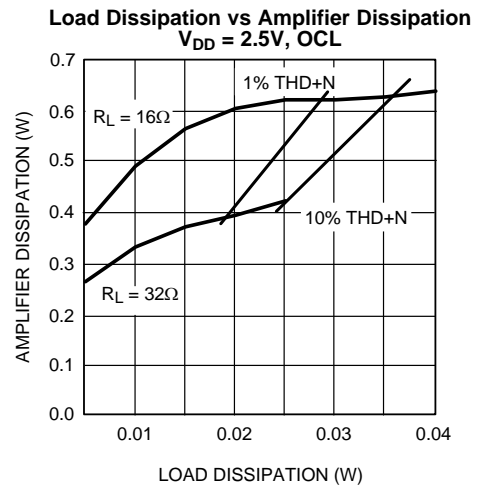

Figure 56.

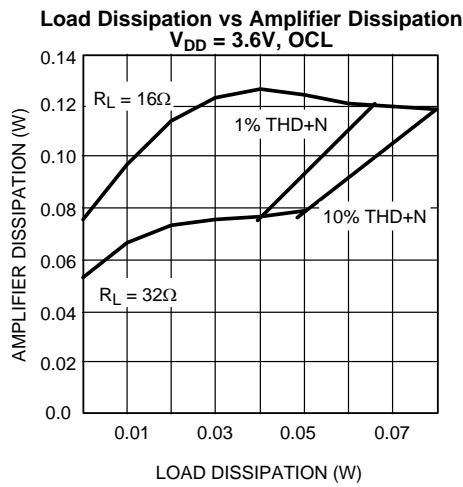

Figure 57.

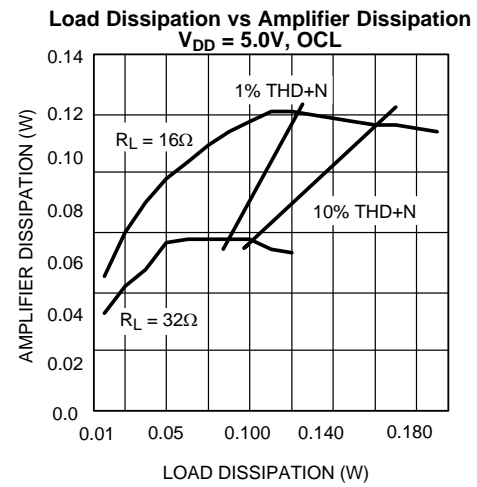

Figure 58.

Typical Performance Characteristics (continued)

T_A = 25°C, A_V = 0dB, f_{IN} = 1kHz unless otherwise stated.

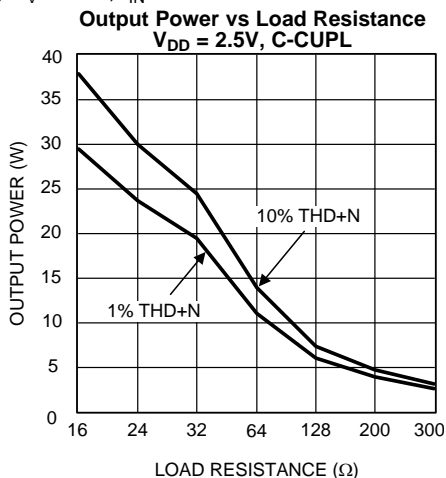

Figure 59.

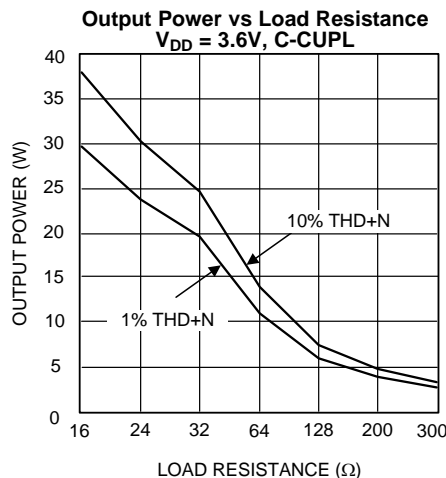

Figure 60.

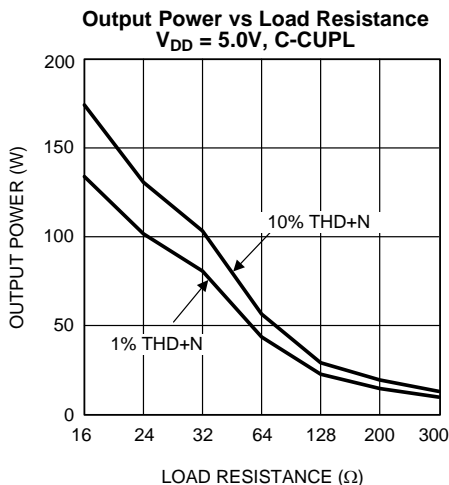

Figure 61.

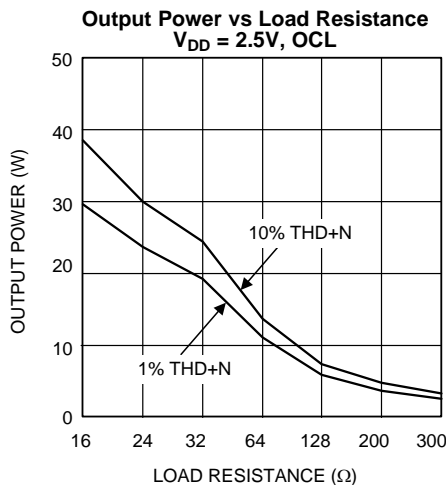

Figure 62.

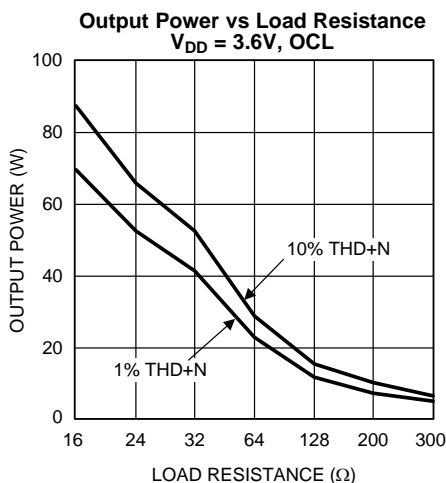

Figure 63.

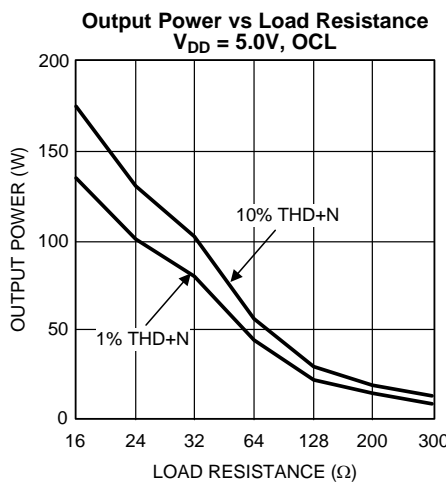

Figure 64.

Typical Performance Characteristics (continued)

T_A = 25°C, A_V = 0dB, f_{IN} = 1kHz unless otherwise stated.

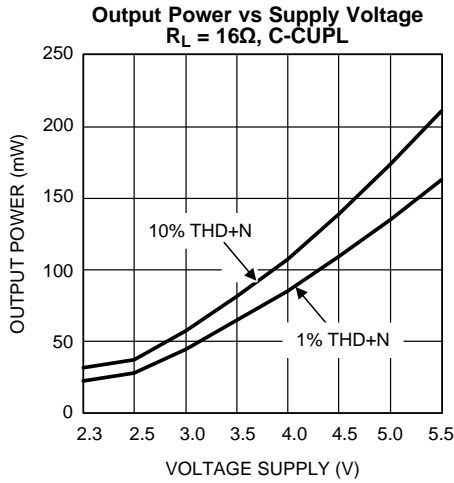

Figure 65.

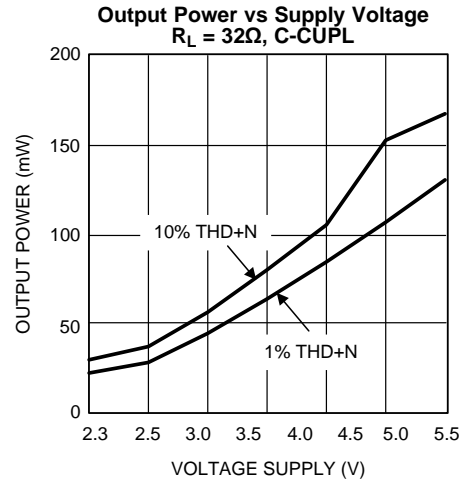

Figure 66.

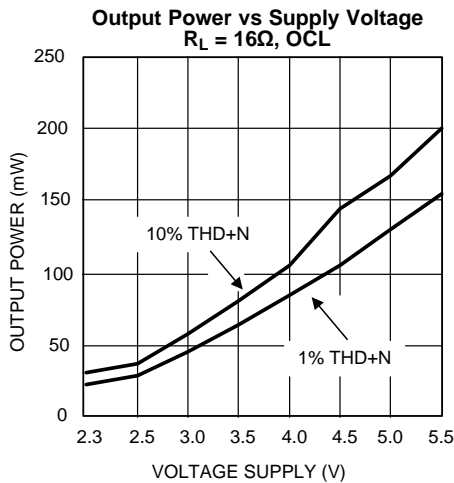

Figure 67.

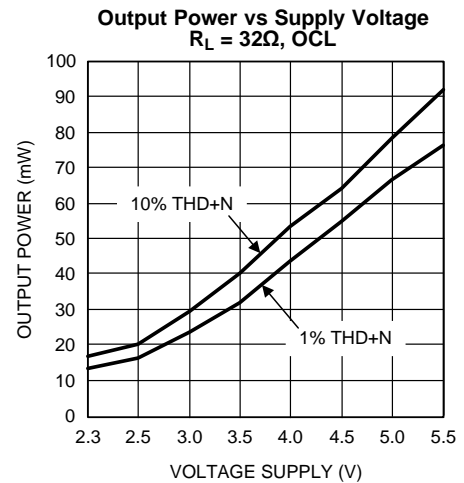

Figure 68.

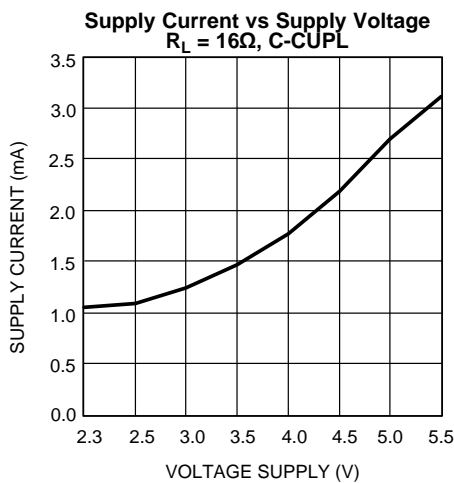

Figure 69.

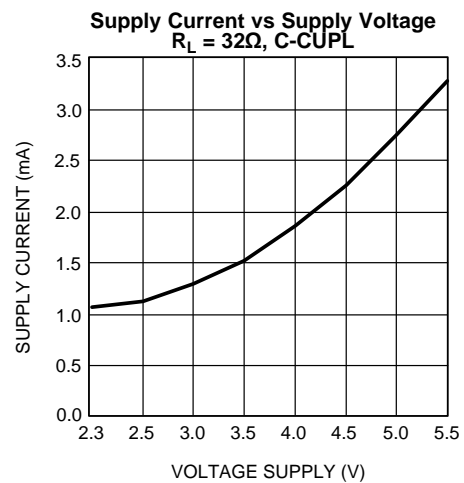

Figure 70.

Typical Performance Characteristics (continued)

T_A = 25°C, A_V = 0dB, f_{IN} = 1kHz unless otherwise stated.

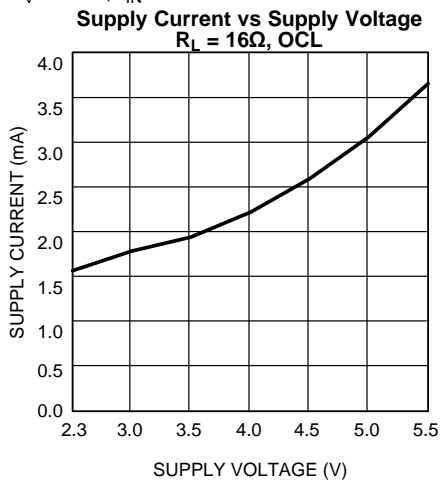

Figure 71.

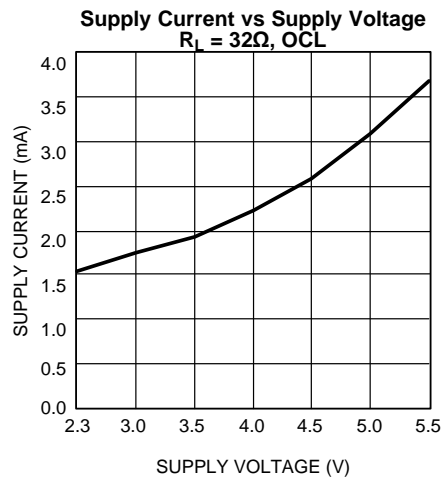

Figure 72.

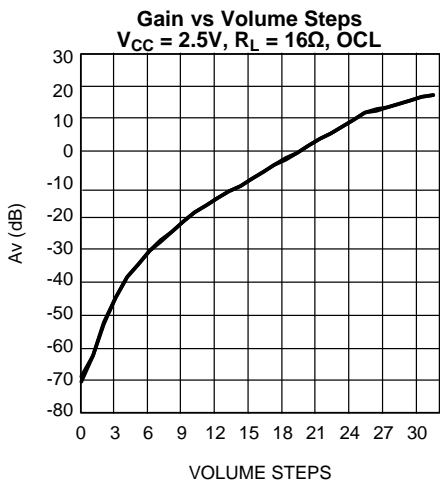

Figure 73.

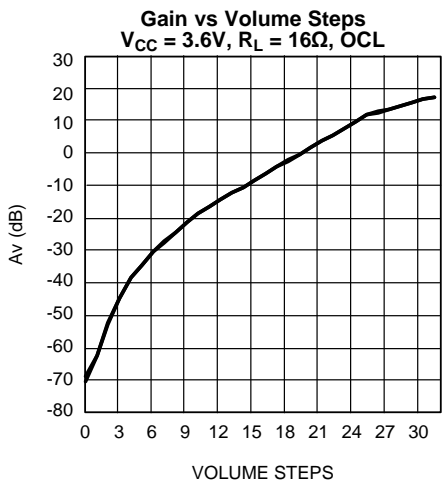

Figure 74.

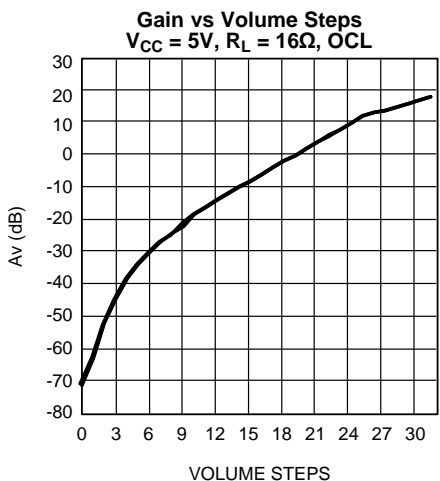

Figure 75.

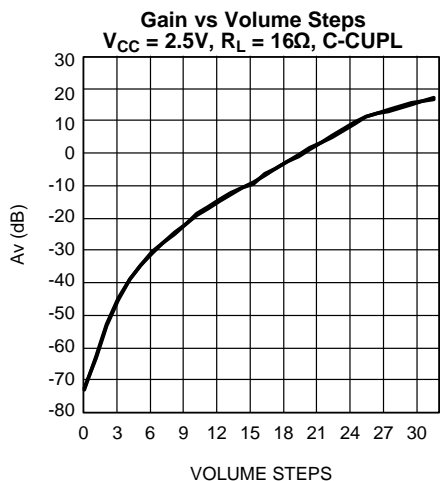
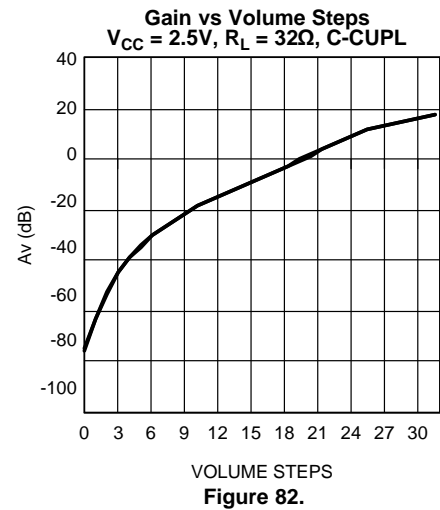
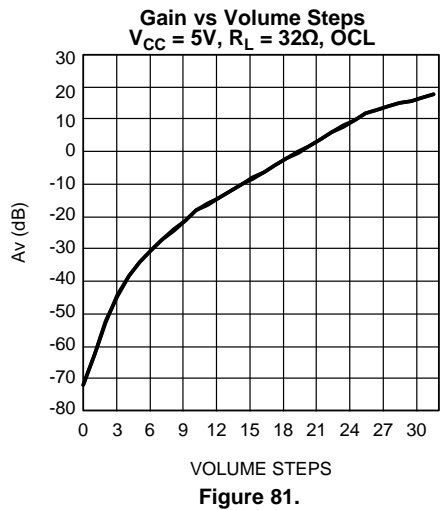
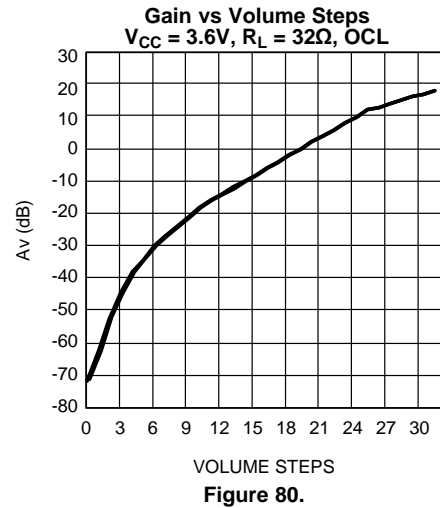
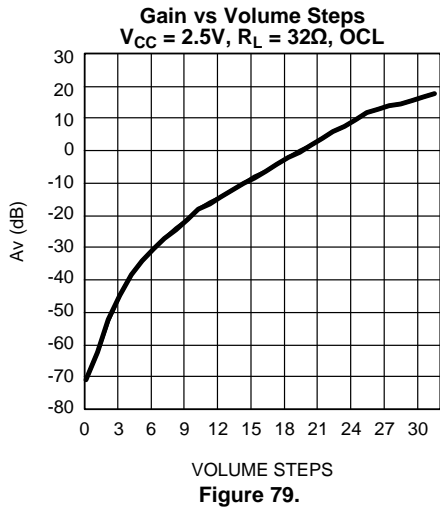
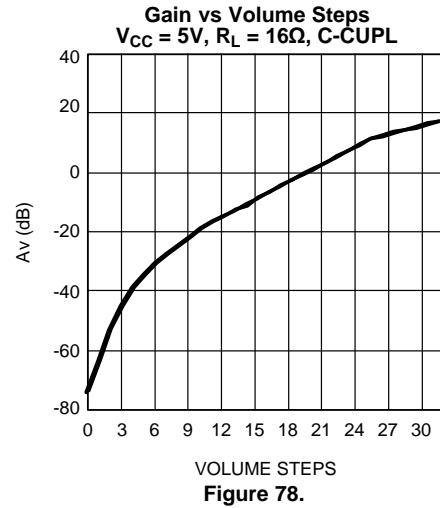
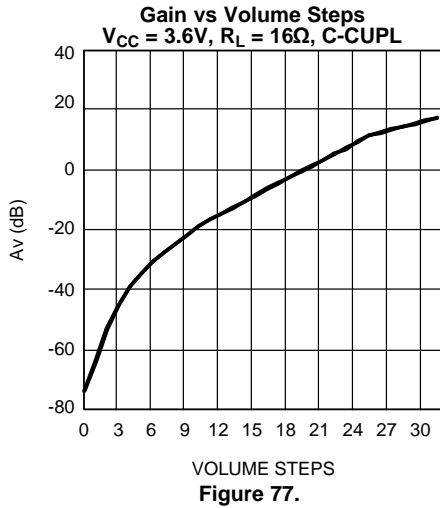

Figure 76.

Typical Performance Characteristics (continued)

$T_A = 25^\circ\text{C}$, $A_V = 0\text{dB}$, $f_{IN} = 1\text{kHz}$ unless otherwise stated.



Typical Performance Characteristics (continued)

$T_A = 25^\circ\text{C}$, $A_V = 0\text{dB}$, $f_{IN} = 1\text{kHz}$ unless otherwise stated.

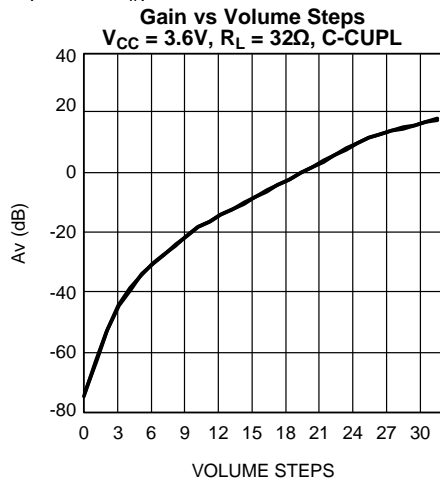

Figure 83.

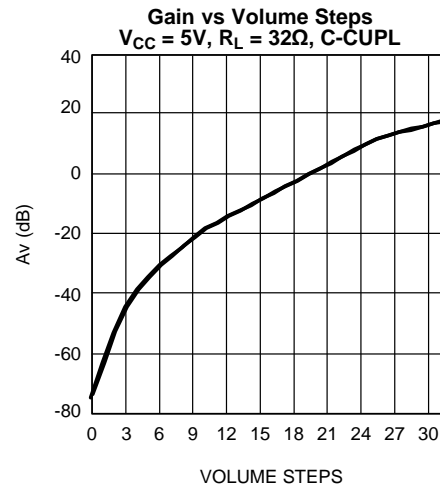

Figure 84.

APPLICATION INFORMATION

AMPLIFIER CONFIGURATION EXPLANATION

As shown in Figure 1, the LM4985 has three internal power amplifiers. Two of the amplifiers which amplify signals applied to their inputs, have internally configurable gain. The remaining third amplifier provides both half-supply output bias and AC ground return.

Loads, such as a headphone speaker, are connected between OUT1 and CNTGND or OUT2 and CNTGND. This configuration does not require an output coupling capacitor. The classical single-ended amplifier configuration, where one side of the load is connected to ground, requires large, expensive output coupling capacitors.

A configuration such as the one used in the LM4985 has a major advantage over single supply, single-ended amplifiers. Since the outputs OUT1, OUT2, and CNTGND are all biased at $1/2 V_{DD}$, no net DC voltage exists across each load. This eliminates the need for output coupling capacitors which are required in a single-supply, single-ended amplifier configuration. Without output coupling capacitors in a typical single-supply, single-ended amplifier, the bias voltage is placed across the load resulting in both increased internal IC power dissipation and possible loudspeaker damage.

The LM4985 eliminates these output coupling capacitors when operating in Output Capacitor-less (OCL) mode. Unless shorted to ground, VoC is internally configured to apply a $1/2 V_{DD}$ bias voltage to a stereo headphone jack's sleeve. This voltage matches the bias voltage present on VoA and VoB outputs that drive the headphones. The headphones operate in a manner similar to a bridge-tied load (BTL). Because the same DC voltage is applied to both headphone speaker terminals this results in no net DC current flow through the speaker. AC current flows through a headphone speaker as an audio signal's output amplitude increases on the speaker's terminal.

The headphone jack's sleeve is not connected to circuit ground when used in OCL mode. Using the headphone output jack as a line-level output will place the LM4985's $1/2 V_{DD}$ bias voltage on a plug's sleeve connection. This presents no difficulty when the external equipment uses capacitively coupled inputs. For the very small minority of equipment that is DC coupled, the LM4985 monitors the current supplied by the amplifier that drives the headphone jack's sleeve. If this current exceeds 500mA_{PEAK} , the amplifier is shutdown, protecting the LM4985 and the external equipment.

POWER DISSIPATION

Power dissipation is a major concern when using any power amplifier. When operating in capacitor-coupled mode (C-CUPL), Equation 1 states the maximum power dissipation point for a single-ended amplifier operating at a given supply voltage and driving a specified output load.

$$P_{DMAX} = 2(V_{DD})^2 / (2\pi^2 R_L) \quad (1)$$

When operating in the OCL mode, the LM4985's three operational amplifiers produce a maximum power dissipation given in Equation 2:

$$P_{DMAX} = [2(V_{DD})^2 / (2\pi^2 R_L)] + [V_{DD}^2 / (4\pi R_L)] \quad (2)$$

The maximum power dissipation point obtained from Equation 1 or Equation 2 must not be greater than the power dissipation that results from Equation 3:

$$P_{DMAX} = (T_{JMAX} - T_A) / \theta_{JA} \quad (3)$$

For package YFQ0012, $\theta_{JA} = 190^\circ\text{C}/\text{W}$. $T_{JMAX} = 150^\circ\text{C}$ for the LM4985. Depending on the ambient temperature, T_A , of the system surroundings, Equation 3 can be used to find the maximum internal power dissipation supported by the IC packaging. If the result of Equation 2 is greater than that of Equation 3, then either the supply voltage must be decreased, the load impedance increased or T_A reduced.

For a typical application using a 3.6V power supply, with a 32Ω load, the maximum ambient temperature possible without violating the maximum junction temperature is approximately 144°C provided that device operation is around the maximum power dissipation point. Thus, for typical applications, power dissipation is not an issue. Power dissipation is a function of output power and thus, if typical operation is not around the maximum power dissipation point, the ambient temperature may be increased accordingly. Refer to the Typical Performance Characteristics curves for power dissipation information for lower output powers.

POWER SUPPLY BYPASSING

As with any amplifier, proper supply bypassing is important for low noise performance and high power supply rejection. The capacitor location on the power supply pins should be as close to the device as possible.

Typical applications employ a regulator with 10 μ F tantalum or electrolytic capacitor and a ceramic bypass capacitor which aid in supply stability. This does not eliminate the need for bypassing the supply nodes of the LM4985. A bypass capacitor value in the range of 0.1 μ F to 1 μ F is recommended for C_S.

MICRO POWER SHUTDOWN

The LM4985's micropower shutdown is activated or deactivated through its I²C digital interface . Please refer to Table 1 for the I²C Address, Register Select, and Mode Control registers. Each amplifier within the LM4985 can be shutdown individually.

Please observe the following protocol when placing an individual amplifier channel in shutdown while the other channel remains active. The protocol requires activating both channels' shutdown simultaneously, then deactivating the shutdown of the channel whose output is desired (or leaving the desired channel in shutdown mode). Also, when operating in the C-CUPL mode, a short delay time is required between activating one channel after placing both channels in shutdown. If the user finds that both channels activate when only one was chosen, increase the delay.

SELECTION OF INPUT CAPACITOR SIZE

Amplifying the lowest audio frequencies requires a high value input coupling capacitor, C_i. A high value capacitor can be expensive and may compromise space efficiency in portable designs. In many cases, however, the headphones used in portable systems have little ability to reproduce signals below 60Hz. Applications using headphones with this limited frequency response reap little improvement by using a high value input capacitor.

In addition to system cost and size, turn on time is affected by the size of the input coupling capacitor C_i. A larger input coupling capacitor requires more charge to reach its quiescent DC voltage. This charge comes from the output via the feedback. Thus, by minimizing the capacitor size based on necessary low frequency response, turn-on time can be minimized. A small value of C_i (in the range of 0.22 μ F to 0.68 μ F), is recommended.

MAXIMIZING OCL MODE CHANNEL-TO-CHANNEL SEPARATION

The OCL mode AC ground return (CNT_GND pin) is shared by both amplifiers. As such, any resistance between the CNT_GND pin and the load will create a voltage divider with respect to the load resistance. In a typical circuit, the amount of CNT_GND resistance can be very small, but still significant. It is significant because of the relatively low load impedances for which the LM4985 was designed to drive: 16 Ω to 32 Ω . The ratio of this voltage divider will determine the magnitude of any residual signal present at the CNT_GND pin. It is this residual signal that leads to channel-to-channel separation (crosstalk) degradation.

For example, for a 60dB channel-to-channel separation while driving a 16 Ω load, the resistance between the LM4985's CNT_GND pin and the load must be less than 16m Ω . This is achieved by ensuring that the trace that connects the CNT_GND pin to the headphone jack sleeve should be as short and massive as possible, given the physical constraints of any specific printed circuit board layout and design.

DEMONSTRATION BOARD AND PCB LAYOUT

Information concerning PCB layout considerations and demonstration board use and performance is found in Application Note AN-1452 (Literature Number [SNAA029](#)).

I²C Control Register

Table 1 shows the actions that are implemented by manipulating the bits within the two internal I²C control registers.

Table 1. LM4985 I²C Control Register Addressing and Data Format Chart

		LM4985 I2C Control Register Addressing and Data Chart							
I2C Address		A6	A5	A4	A3	A2	A1	A0	Function
		1	1	0	0	1	1	A0	
Register Select	D7	D6	D5	D4	D3	D2	RS1	RS0	
	0	0	0	0	0	0	0	0	Read and write the mode control register
	0	0	0	0	0	0	0	1	Read and write the volume control register
Mode Control Register	D7	D6	D5	D4	D3	D2	D1	D0	
		WT1	WT0	PHG	SDCH1	SDCH2	CHSEL1	CHSEL2	
	0	X	X	X	X	X	X	X	D7 must always be set to 0
	–	0	0	X	X	X	X	X	Wake-up time: 80ms (OCL), 250ms (C-CUPL)
	–	0	1	X	X	X	X	X	Wake-up time: 110ms (OCL), 450ms (C-CUPL)
	–	1	0	X	X	X	X	X	Wake-up time: 170ms (OCL), 850ms (C-CUPL)
	–	1	1	X	X	X	X	X	Wake-up time: 290ms (OCL), 1650ms (C-CUPL)
	–	X	X	1	X	X	X	X	Output capacitor-less mode active
	–	X	X	0	X	X	X	X	Output capacitor-less mode inactive
	–	X	X	X	0	0	X	X	Amplifier's SHUTDOWN mode active
	–	X	X	X	0	1	X	X	Illegal mode
	–	X	X	X	1	0	X	X	Illegal mode
	–	X	X	X	1	1	X	X	Amplifier's SHUTDOWN mode inactive
	–	X	X	X	X	X	0	02	Amplifier's Chan. 1 is Input 1 , Chan 2. is Input 2
	–	X	X	X	X	X	0	1	Amplifier's Chan. 1 is Input 1 , Chan 2. is Input 1
	–	X	X	X	X	X	1	0	Amplifier's Chan. 1 is Input 2 , Chan 2. is Input 2
–	X	X	X	X	X	1	1	Amplifier's Chan. 1 is Input 2 , Chan 2. is Input 1	

Volume Control Settings Binary Values

The minimum volume setting is set to -76dB when 00000 is loaded into the volume control register. Incrementing the volume control register in binary fashion increases the volume control setting, reaching full scale at 11111. [Table 2](#) shows the value of the gain for each of the 32 binary volume control settings.

Table 2. Binary Values for the Different Volume Control Gain Settings

Gain	B4	B3	B2	B1	B0
18	1	1	1	1	1
17	1	1	1	1	0
16	1	1	1	0	1
15	1	1	1	0	0
14	1	1	0	1	1
13	1	1	0	1	0
12	1	1	0	0	1
10	1	1	0	0	0
8	1	0	1	1	1
6	1	0	1	1	0
4	1	0	1	0	1
2	1	0	1	0	0
0	1	0	0	1	1
-2	1	0	0	1	0
-4	1	0	0	0	1
-6	1	0	0	0	0
-8	0	1	1	1	1
-10	0	1	1	1	0
-12	0	1	1	0	1
-14	0	1	1	0	0
-16	0	1	0	1	1
-18	0	1	0	1	0
-21	0	1	0	0	1
-24	0	1	0	0	0
-27	0	0	1	1	1
-30	0	0	1	1	0
-34	0	0	1	0	1
-38	0	0	1	0	0
-44	0	0	0	1	1
-52	0	0	0	1	0
-62	0	0	0	0	1
-76	0	0	0	0	0

Revision History

Rev	Date	Description
1.0	05/17/06	Initial WEB release.

REVISION HISTORY

Changes from Revision B (April 2013) to Revision C	Page
• Changed layout of National Data Sheet to TI format	27

PACKAGING INFORMATION

Orderable Device	Status (1)	Package Type	Package Drawing	Pins	Package Qty	Eco Plan (2)	Lead/Ball Finish	MSL Peak Temp (3)	Op Temp (°C)	Top-Side Markings (4)	Samples
LM4985TM/NOPB	ACTIVE	DSBGA	YFQ	12	250	Green (RoHS & no Sb/Br)	SNAGCU	Level-1-260C-UNLIM	-40 to 85	G H2	Samples
LM4985TMX/NOPB	ACTIVE	DSBGA	YFQ	12	3000	Green (RoHS & no Sb/Br)	SNAGCU	Level-1-260C-UNLIM	-40 to 85	G H2	Samples

(1) The marketing status values are defined as follows:

ACTIVE: Product device recommended for new designs.

LIFEBUY: TI has announced that the device will be discontinued, and a lifetime-buy period is in effect.

NRND: Not recommended for new designs. Device is in production to support existing customers, but TI does not recommend using this part in a new design.

PREVIEW: Device has been announced but is not in production. Samples may or may not be available.

OBSOLETE: TI has discontinued the production of the device.

(2) Eco Plan - The planned eco-friendly classification: Pb-Free (RoHS), Pb-Free (RoHS Exempt), or Green (RoHS & no Sb/Br) - please check <http://www.ti.com/productcontent> for the latest availability information and additional product content details.

TBD: The Pb-Free/Green conversion plan has not been defined.

Pb-Free (RoHS): TI's terms "Lead-Free" or "Pb-Free" mean semiconductor products that are compatible with the current RoHS requirements for all 6 substances, including the requirement that lead not exceed 0.1% by weight in homogeneous materials. Where designed to be soldered at high temperatures, TI Pb-Free products are suitable for use in specified lead-free processes.

Pb-Free (RoHS Exempt): This component has a RoHS exemption for either 1) lead-based flip-chip solder bumps used between the die and package, or 2) lead-based die adhesive used between the die and leadframe. The component is otherwise considered Pb-Free (RoHS compatible) as defined above.

Green (RoHS & no Sb/Br): TI defines "Green" to mean Pb-Free (RoHS compatible), and free of Bromine (Br) and Antimony (Sb) based flame retardants (Br or Sb do not exceed 0.1% by weight in homogeneous material)

(3) MSL, Peak Temp. -- The Moisture Sensitivity Level rating according to the JEDEC industry standard classifications, and peak solder temperature.

(4) Multiple Top-Side Markings will be inside parentheses. Only one Top-Side Marking contained in parentheses and separated by a "~" will appear on a device. If a line is indented then it is a continuation of the previous line and the two combined represent the entire Top-Side Marking for that device.

Important Information and Disclaimer: The information provided on this page represents TI's knowledge and belief as of the date that it is provided. TI bases its knowledge and belief on information provided by third parties, and makes no representation or warranty as to the accuracy of such information. Efforts are underway to better integrate information from third parties. TI has taken and continues to take reasonable steps to provide representative and accurate information but may not have conducted destructive testing or chemical analysis on incoming materials and chemicals. TI and TI suppliers consider certain information to be proprietary, and thus CAS numbers and other limited information may not be available for release.

In no event shall TI's liability arising out of such information exceed the total purchase price of the TI part(s) at issue in this document sold by TI to Customer on an annual basis.

TAPE AND REEL INFORMATION

QUADRANT ASSIGNMENTS FOR PIN 1 ORIENTATION IN TAPE

*All dimensions are nominal

Device	Package Type	Package Drawing	Pins	SPQ	Reel Diameter (mm)	Reel Width W1 (mm)	A0 (mm)	B0 (mm)	K0 (mm)	P1 (mm)	W (mm)	Pin1 Quadrant
LM4985TM/NOPB	DSBGA	YFQ	12	250	178.0	8.4	1.35	1.75	0.76	4.0	8.0	Q1
LM4985TMX/NOPB	DSBGA	YFQ	12	3000	178.0	8.4	1.35	1.75	0.76	4.0	8.0	Q1

TAPE AND REEL BOX DIMENSIONS

*All dimensions are nominal

Device	Package Type	Package Drawing	Pins	SPQ	Length (mm)	Width (mm)	Height (mm)
LM4985TM/NOPB	DSBGA	YFQ	12	250	210.0	185.0	35.0
LM4985TMX/NOPB	DSBGA	YFQ	12	3000	210.0	185.0	35.0

IMPORTANT NOTICE

Texas Instruments Incorporated and its subsidiaries (TI) reserve the right to make corrections, enhancements, improvements and other changes to its semiconductor products and services per JESD46, latest issue, and to discontinue any product or service per JESD48, latest issue. Buyers should obtain the latest relevant information before placing orders and should verify that such information is current and complete. All semiconductor products (also referred to herein as "components") are sold subject to TI's terms and conditions of sale supplied at the time of order acknowledgment.

TI warrants performance of its components to the specifications applicable at the time of sale, in accordance with the warranty in TI's terms and conditions of sale of semiconductor products. Testing and other quality control techniques are used to the extent TI deems necessary to support this warranty. Except where mandated by applicable law, testing of all parameters of each component is not necessarily performed.

TI assumes no liability for applications assistance or the design of Buyers' products. Buyers are responsible for their products and applications using TI components. To minimize the risks associated with Buyers' products and applications, Buyers should provide adequate design and operating safeguards.

TI does not warrant or represent that any license, either express or implied, is granted under any patent right, copyright, mask work right, or other intellectual property right relating to any combination, machine, or process in which TI components or services are used. Information published by TI regarding third-party products or services does not constitute a license to use such products or services or a warranty or endorsement thereof. Use of such information may require a license from a third party under the patents or other intellectual property of the third party, or a license from TI under the patents or other intellectual property of TI.

Reproduction of significant portions of TI information in TI data books or data sheets is permissible only if reproduction is without alteration and is accompanied by all associated warranties, conditions, limitations, and notices. TI is not responsible or liable for such altered documentation. Information of third parties may be subject to additional restrictions.

Resale of TI components or services with statements different from or beyond the parameters stated by TI for that component or service voids all express and any implied warranties for the associated TI component or service and is an unfair and deceptive business practice. TI is not responsible or liable for any such statements.

Buyer acknowledges and agrees that it is solely responsible for compliance with all legal, regulatory and safety-related requirements concerning its products, and any use of TI components in its applications, notwithstanding any applications-related information or support that may be provided by TI. Buyer represents and agrees that it has all the necessary expertise to create and implement safeguards which anticipate dangerous consequences of failures, monitor failures and their consequences, lessen the likelihood of failures that might cause harm and take appropriate remedial actions. Buyer will fully indemnify TI and its representatives against any damages arising out of the use of any TI components in safety-critical applications.

In some cases, TI components may be promoted specifically to facilitate safety-related applications. With such components, TI's goal is to help enable customers to design and create their own end-product solutions that meet applicable functional safety standards and requirements. Nonetheless, such components are subject to these terms.

No TI components are authorized for use in FDA Class III (or similar life-critical medical equipment) unless authorized officers of the parties have executed a special agreement specifically governing such use.

Only those TI components which TI has specifically designated as military grade or "enhanced plastic" are designed and intended for use in military/aerospace applications or environments. Buyer acknowledges and agrees that any military or aerospace use of TI components which have **not** been so designated is solely at the Buyer's risk, and that Buyer is solely responsible for compliance with all legal and regulatory requirements in connection with such use.

TI has specifically designated certain components as meeting ISO/TS16949 requirements, mainly for automotive use. In any case of use of non-designated products, TI will not be responsible for any failure to meet ISO/TS16949.

Products

Audio	www.ti.com/audio
Amplifiers	amplifier.ti.com
Data Converters	dataconverter.ti.com
DLP® Products	www.dlp.com
DSP	dsp.ti.com
Clocks and Timers	www.ti.com/clocks
Interface	interface.ti.com
Logic	logic.ti.com
Power Mgmt	power.ti.com
Microcontrollers	microcontroller.ti.com
RFID	www.ti-rfid.com
OMAP Applications Processors	www.ti.com/omap
Wireless Connectivity	www.ti.com/wirelessconnectivity

Applications

Automotive and Transportation	www.ti.com/automotive
Communications and Telecom	www.ti.com/communications
Computers and Peripherals	www.ti.com/computers
Consumer Electronics	www.ti.com/consumer-apps
Energy and Lighting	www.ti.com/energy
Industrial	www.ti.com/industrial
Medical	www.ti.com/medical
Security	www.ti.com/security
Space, Avionics and Defense	www.ti.com/space-avionics-defense
Video and Imaging	www.ti.com/video

TI E2E Community

e2e.ti.com