

## LM5106 100V Half Bridge Gate Driver with Programmable Dead-Time

 Check for Samples: [LM5106](#)

### FEATURES

- Drives Both a High Side and Low Side N-Channel MOSFET
- 1.8A Peak Output Sink Current
- 1.2A Peak Output Source Current
- Bootstrap Supply Voltage Range up to 118V DC
- Single TTL Compatible Input
- Programmable Turn-On Delays (Dead-Time)
- Enable Input Pin
- Fast Turn-Off Propagation Delays (32ns Typical)
- Drives 1000pF with 15ns Rise and 10ns Fall Time
- Supply Rail Under-Voltage Lockout
- Low Power Consumption

### APPLICATIONS

- Solid State Motor Drives
- Half and Full Bridge Power Converters
- Two Switch Forward Power Converters

### Simplified Block Diagram

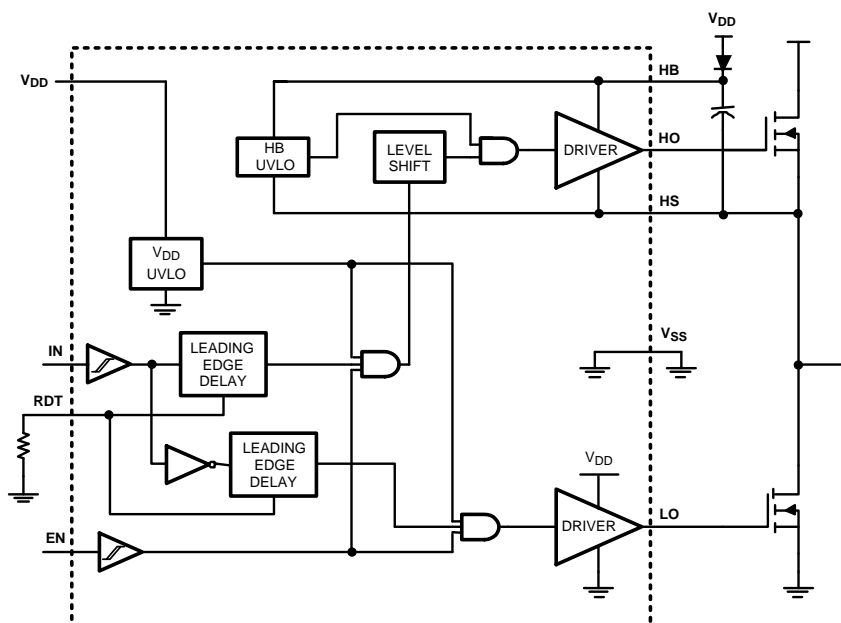

### PACKAGE

- WSON-10 (4 mm x 4 mm)
- VSSOP-10

### DESCRIPTION

The LM5106 is a high voltage gate driver designed to drive both the high side and low side N-Channel MOSFETs in a synchronous buck or half bridge configuration. The floating high side driver is capable of working with rail voltages up to 100V. The single control input is compatible with TTL signal levels and a single external resistor programs the switching transition dead-time through tightly matched turn-on delay circuits. The robust level shift technology operates at high speed while consuming low power and provides clean output transitions. Under-voltage lockout disables the gate driver when either the low side or the bootstrapped high side supply voltage is below the operating threshold. The LM5106 is offered in the VSSOP-10 or thermally enhanced 10-pin WSON plastic package.



Please be aware that an important notice concerning availability, standard warranty, and use in critical applications of Texas Instruments semiconductor products and disclaimers thereto appears at the end of this data sheet.

All trademarks are the property of their respective owners.

## Connection Diagram

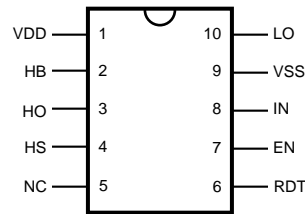

**Figure 1. 10-Lead VSSOP or WSON  
See DGS or DPR0010A Package**

### PIN DESCRIPTIONS

Pin #	Name	Description	Application Information
1	VDD	Positive gate drive supply	Decouple VDD to VSS using a low ESR/ESL capacitor, placed as close to the IC as possible.
2	HD	High side gate driver bootstrap rail	Connect the positive terminal of bootstrap capacitor to the HB pin and connect negative terminal to HS. The Bootstrap capacitor should be placed as close to IC as possible.
3	HO	High side gate driver output	Connect to the gate of high side N-MOS device through a short, low inductance path.
4	HS	High side MOSFET source connection	Connect to the negative terminal of the bootstrap capacitor and to the source of the high side N-MOS device.
5	NC	Not Connected	
6	RDT	Dead-time programming pin	A resistor from RDT to VSS programs the turn-on delay of both the high and low side MOSFETs. The resistor should be placed close to the IC to minimize noise coupling from adjacent PC board traces.
7	EN	Logic input for driver Disable/Enable	TTL compatible threshold with hysteresis. LO and HO are held in the low state when EN is low.
8	IN	Logic input for gate driver	TTL compatible threshold with hysteresis. The high side MOSFET is turned on and the low side MOSFET turned off when IN is high.
9	VSS	Ground return	All signals are referenced to this ground.
10	LO	Low side gate driver output	Connect to the gate of the low side N-MOS device with a short, low inductance path.
NA	EP	Exposed Pad	The exposed pad has no electrical contact. Connect to system ground plane for reduced thermal resistance.



These devices have limited built-in ESD protection. The leads should be shorted together or the device placed in conductive foam during storage or handling to prevent electrostatic damage to the MOS gates.

**Absolute Maximum Ratings<sup>(1)(2)</sup>**

$V_{DD}$ to $V_{SS}$	-0.3V to +18V
HB to HS	-0.3V to +18V
IN and EN to $V_{SS}$	-0.3V to $V_{DD} + 0.3V$
LO to $V_{SS}$	-0.3V to $V_{DD} + 0.3V$
HO to $V_{SS}$	HS - 0.3V to HB + 0.3V
HS to $V_{SS}$ <sup>(3)</sup>	-5V to +100V
HB to $V_{SS}$	118V
RDT to $V_{SS}$	-0.3V to 5V
Junction Temperature	+150°C
Storage Temperature Range	-55°C to +150°C
ESD Rating HBM <sup>(4)</sup>	1.5 kV

- (1) Absolute Maximum Ratings indicate limits beyond which damage to the component may occur. Operating Ratings are conditions under which operation of the device is ensured. Operating Ratings do not imply ensured performance limits. For ensured performance limits and associated test conditions, see the [Electrical Characteristics](#).
- (2) If Military/Aerospace specified devices are required, please contact the Texas Instruments Sales Office/Distributors for availability and specifications.
- (3) In the application the HS node is clamped by the body diode of the external lower N-MOSFET, therefore the HS voltage will generally not exceed -1V. However in some applications, board resistance and inductance may result in the HS node exceeding this stated voltage transiently. If negative transients occur on HS, the HS voltage must never be more negative than  $V_{DD} - 15V$ . For example, if  $V_{DD} = 10V$ , the negative transients at HS must not exceed -5V.
- (4) The human body model is a 100 pF capacitor discharged through a 1.5kΩ resistor into each pin. Pin 2, Pin 3 and Pin 4 are rated at 500V.

**Recommended Operating Conditions**

$V_{DD}$	+8V to +14V
HS <sup>(1)</sup>	-1V to 100V
HB	HS + 8V to HS + 14V
HS Slew Rate	< 50V/ns
Junction Temperature	-40°C to +125°C

- (1) In the application the HS node is clamped by the body diode of the external lower N-MOSFET, therefore the HS voltage will generally not exceed -1V. However in some applications, board resistance and inductance may result in the HS node exceeding this stated voltage transiently. If negative transients occur on HS, the HS voltage must never be more negative than  $V_{DD} - 15V$ . For example, if  $V_{DD} = 10V$ , the negative transients at HS must not exceed -5V.

**Electrical Characteristics**

Specifications in standard typeface are for  $T_J = +25^\circ\text{C}$ , and those in **boldface type** apply over the full **operating junction temperature range**. Unless otherwise specified,  $V_{DD} = \text{HB} = 12V$ ,  $V_{SS} = \text{HS} = 0V$ ,  $\text{EN} = 5V$ . No load on LO or HO. RDT = 100kΩ<sup>(1)</sup>.

Symbol	Parameter	Conditions	Min	Typ	Max	Units
<b>SUPPLY CURRENTS</b>						
$I_{DD}$	$V_{DD}$ Quiescent Current	IN = EN = 0V		0.34	<b>0.6</b>	mA
$I_{DDO}$	$V_{DD}$ Operating Current	f = 500 kHz		2.1	<b>3.5</b>	mA
$I_{HB}$	Total HB Quiescent Current	IN = EN = 0V		0.06	<b>0.2</b>	mA
$I_{HBO}$	Total HB Operating Current	f = 500 kHz		1.5	<b>3</b>	mA
$I_{HBS}$	HB to $V_{SS}$ Current, Quiescent	HS = HB = 100V		0.1	<b>10</b>	μA
$I_{HBSO}$	HB to $V_{SS}$ Current, Operating	f = 500 kHz		0.5		mA
<b>INPUT IN and EN</b>						
$V_{IL}$	Low Level Input Voltage Threshold		<b>0.8</b>	1.8		V
$V_{IH}$	High Level Input Voltage Threshold			1.8	<b>2.2</b>	V
$R_{pd}$	Input Pulldown Resistance Pin IN and EN		<b>100</b>	200	<b>500</b>	kΩ

- (1) Min and Max limits are 100% production tested at 25°C. Limits over the operating temperature range are ensured through correlation using Statistical Quality Control (SQC) methods. Limits are used to calculate Average Outgoing Quality Level (AOQL).

## Electrical Characteristics (continued)

Specifications in standard typeface are for  $T_J = +25^\circ\text{C}$ , and those in **boldface type** apply over the full **operating junction temperature range**. Unless otherwise specified,  $V_{DD} = HB = 12\text{V}$ ,  $V_{SS} = HS = 0\text{V}$ ,  $EN = 5\text{V}$ . No load on LO or HO.  $\text{RDT} = 100\text{k}\Omega^{(1)}$ .

Symbol	Parameter	Conditions	Min	Typ	Max	Units
<b>DEAD-TIME CONTROLS</b>						
VRDT	Nominal Voltage at RDT		<b>2.7</b>	3	<b>3.3</b>	V
IRDT	RDT Pin Current Limit	RDT = 0V	<b>0.75</b>	1.5	<b>2.25</b>	mA
<b>UNDER VOLTAGE PROTECTION</b>						
$V_{DDR}$	$V_{DD}$ Rising Threshold		<b>6.2</b>	6.9	<b>7.6</b>	V
$V_{DDH}$	$V_{DD}$ Threshold Hysteresis			0.5		V
$V_{HBR}$	HB Rising Threshold		<b>5.9</b>	6.6	<b>7.3</b>	V
$V_{HBH}$	HB Threshold Hysteresis			0.4		V
<b>LO GATE DRIVER</b>						
$V_{OLL}$	Low-Level Output Voltage	$I_{LO} = 100\text{ mA}$		0.21	<b>0.4</b>	V
$V_{OHL}$	High-Level Output Voltage	$I_{LO} = -100\text{ mA}$ , $V_{OHL} = V_{DD} - V_{LO}$		0.5	<b>0.85</b>	V
$I_{OHL}$	Peak Pullup Current	LO = 0V		1.2		A
$I_{OLL}$	Peak Pulldown Current	LO = 12V		1.8		A
<b>HO GATE DRIVER</b>						
$V_{OLH}$	Low-Level Output Voltage	$I_{HO} = 100\text{ mA}$		0.21	<b>0.4</b>	V
$V_{OHH}$	High-Level Output Voltage	$I_{HO} = -100\text{ mA}$ , $V_{OHH} = HB - HO$		0.5	<b>0.85</b>	V
$I_{OHH}$	Peak Pullup Current	HO = 0V		1.2		A
$I_{OLH}$	Peak Pulldown Current	HO = 12V		1.8		A
<b>THERMAL RESISTANCE</b>						
$\theta_{JA}$	Junction to Ambient	See <sup>(2)(3)</sup>		40		$^\circ\text{C/W}$

(2) 4 layer board with Cu finished thickness 1.5/1.0/1.0/1.5 oz. Maximum die size used. 5x body length of Cu trace on PCB top. 50 x 50mm ground and power planes embedded in PCB. See Application Note AN-1187.

(3) The  $\theta_{JA}$  is not a constant for the package and depends on the printed circuit board design and the operating conditions.

## Switching Characteristics

Specifications in standard typeface are for  $T_J = +25^\circ\text{C}$ , and those in **boldface type** apply over the full **operating junction temperature range**. Unless otherwise specified,  $V_{DD} = HB = 12\text{V}$ ,  $V_{SS} = HS = 0\text{V}$ , No Load on LO or HO <sup>(1)</sup>.

Symbol	Parameter	Conditions	Min	Typ	Max	Units
$t_{LPHL}$	Lower Turn-Off Propagation Delay			32	<b>56</b>	ns
$t_{HPHL}$	Upper Turn-Off Propagation Delay			32	<b>56</b>	ns
$t_{LPLH}$	Lower Turn-On Propagation Delay	RDT = 100k	<b>400</b>	520	<b>640</b>	ns
$t_{HPLH}$	Upper Turn-On Propagation Delay	RDT = 100k	<b>450</b>	570	<b>690</b>	ns
$t_{LPLH}$	Lower Turn-On Propagation Delay	RDT = 10k	<b>85</b>	115	<b>160</b>	ns
$t_{HPLH}$	Upper Turn-On Propagation Delay	RDT = 10k	<b>85</b>	115	<b>160</b>	ns
$t_{en}, t_{sd}$	Enable and Shutdown propagation delay			36		ns
DT1, DT2	Dead-time LO OFF to HO ON & HO OFF to LO ON	RDT = 100k		510		ns
		RDT = 10k		86		ns
MDT	Dead-time matching	RDT = 100k		50		ns
$t_R$	Either Output Rise Time	$C_L = 1000\text{pF}$		15		ns
$t_F$	Either Output Fall Time	$C_L = 1000\text{pF}$		10		ns

(1) Min and Max limits are 100% production tested at  $25^\circ\text{C}$ . Limits over the operating temperature range are ensured through correlation using Statistical Quality Control (SQC) methods. Limits are used to calculate Average Outgoing Quality Level (AOQL).

Typical Performance Characteristics

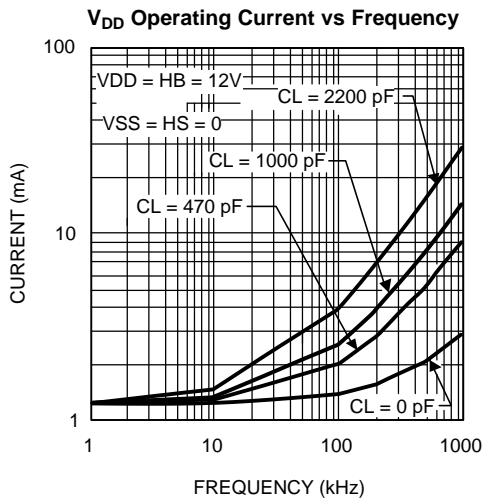

Figure 2.

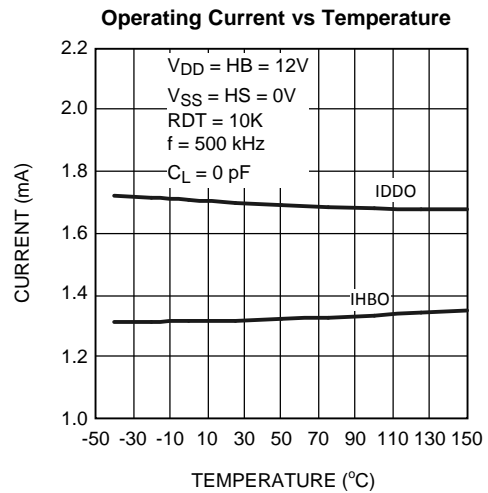

Figure 3.

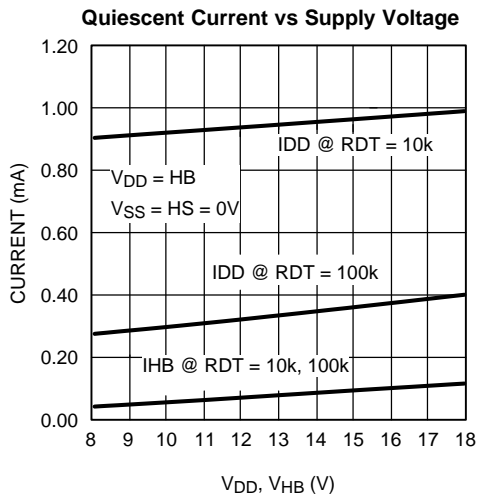

Figure 4.

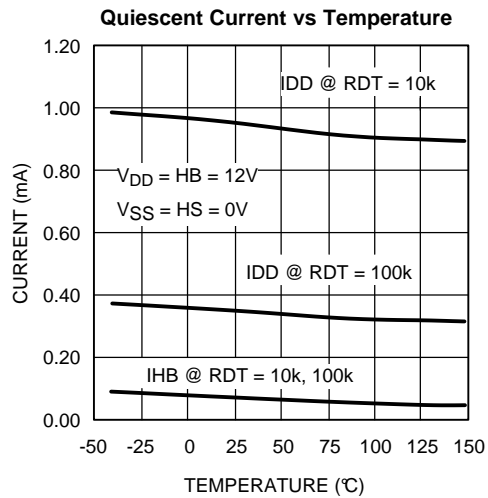

Figure 5.

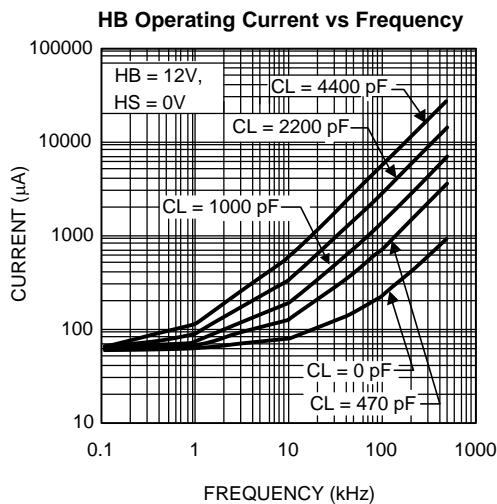

Figure 6.

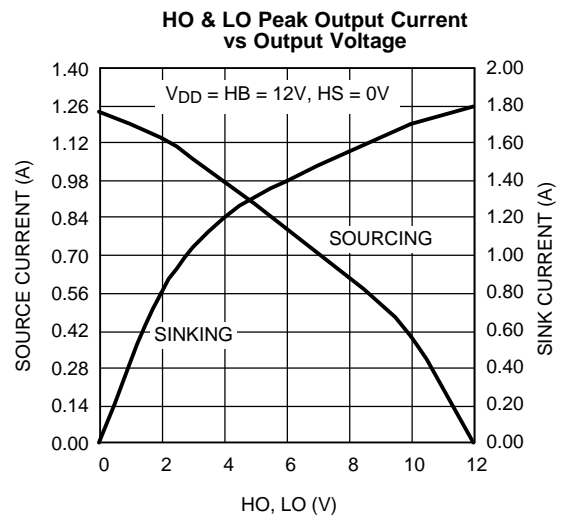

Figure 7.

**Typical Performance Characteristics (continued)**

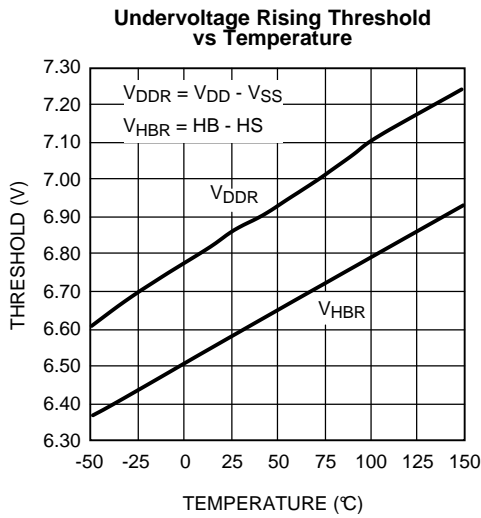

Figure 8.

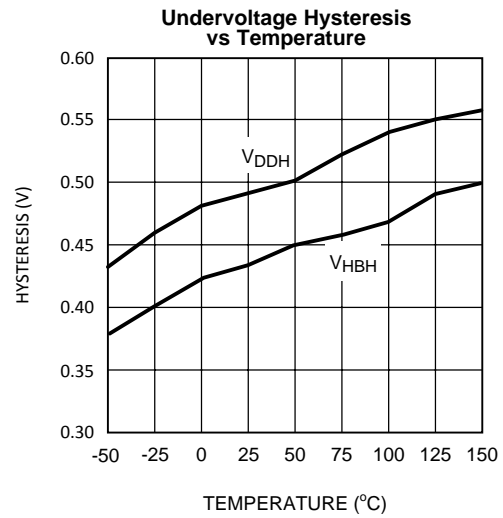

Figure 9.

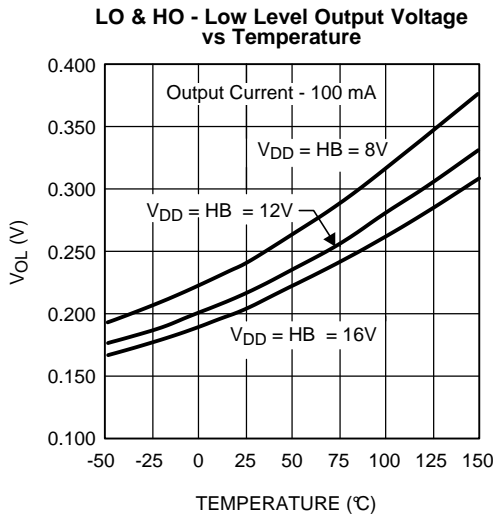

Figure 10.

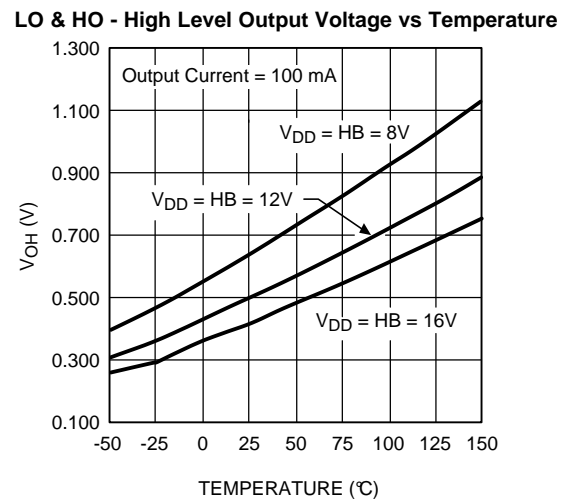

Figure 11.

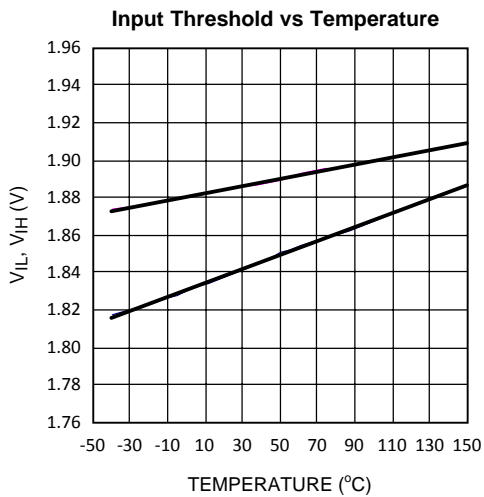

Figure 12.

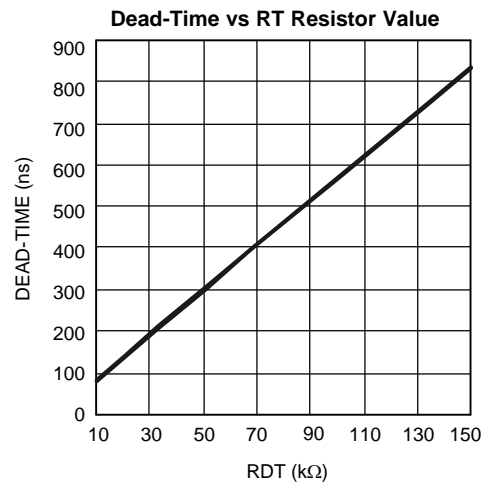

Figure 13.

Typical Performance Characteristics (continued)

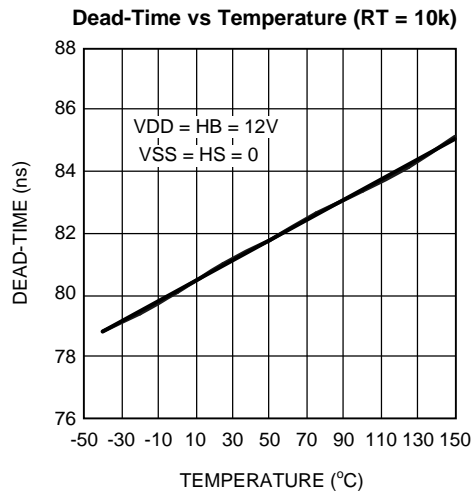

Figure 14.

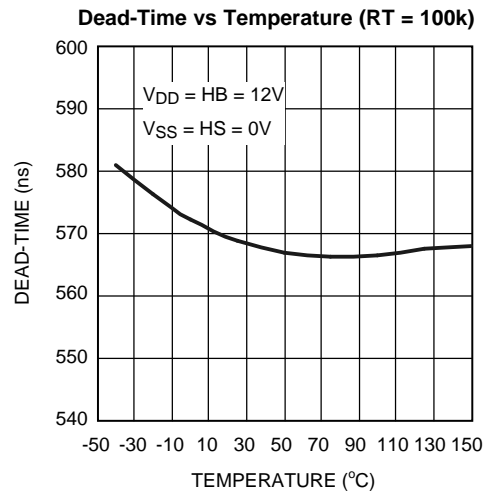

Figure 15.

Timing Diagrams

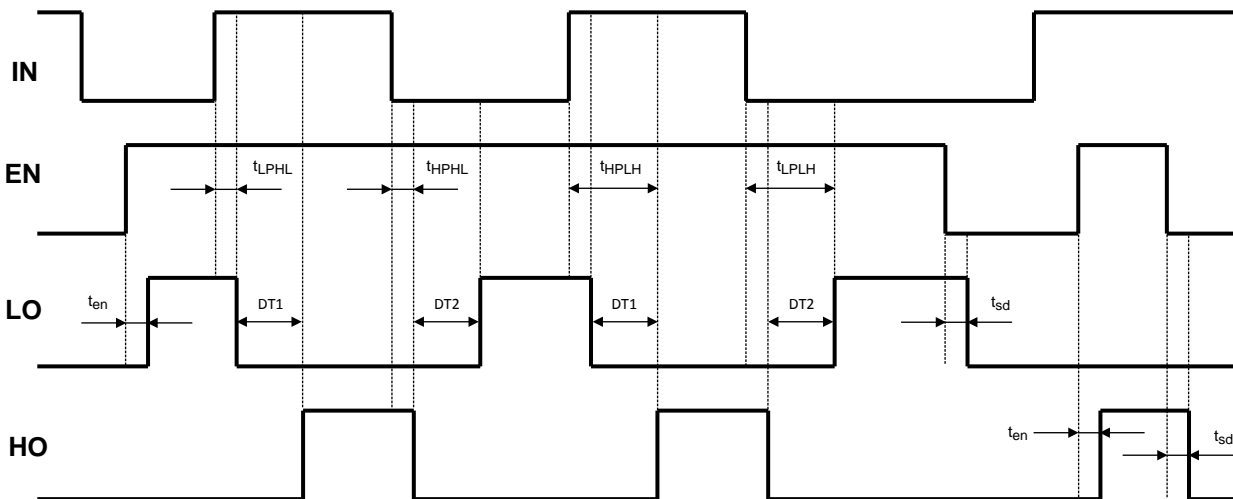

Figure 16. LM5106 Input - Output Waveforms

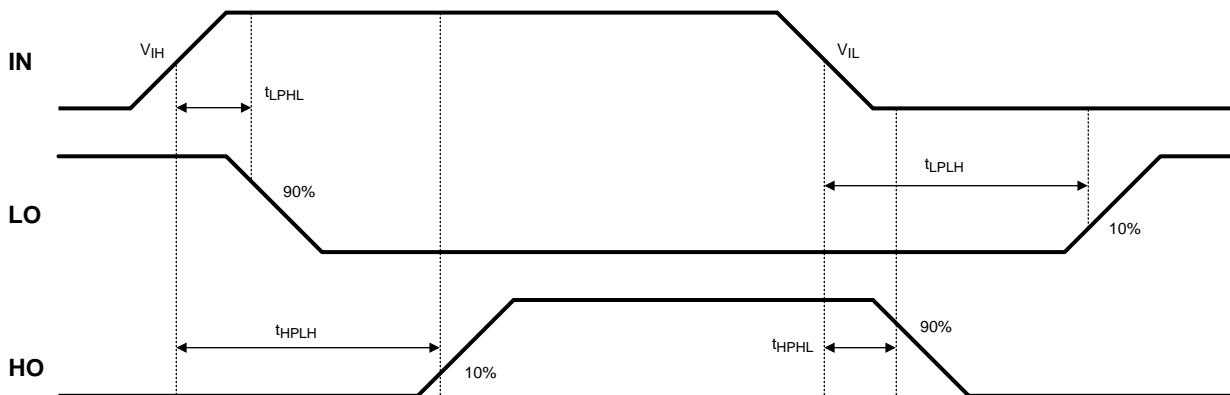

Figure 17. LM5106 Switching Time Definitions:  $t_{LPLH}$ ,  $t_{LPHL}$ ,  $t_{HPLH}$ ,  $t_{HPHL}$

Figure 18. LM5106 Enable:  $t_{sd}$ 

Figure 19. LM5106 Dead-time: DT

## Operational Notes

The LM5106 is a single PWM input Gate Driver with Enable that offers a programmable dead-time. The dead-time is set with a resistor at the RDT pin and can be adjusted from 100ns to 600ns. The wide dead-time programming range provides the flexibility to optimize drive signal timing for a wide range of MOSFETS and applications.

The RDT pin is biased at 3V and current limited to 1 mA maximum programming current. The time delay generator will accommodate resistor values from 5k to 100k with a dead-time time that is proportional to the RDT resistance. Grounding the RDT pin programs the LM5106 to drive both outputs with minimum dead-time.

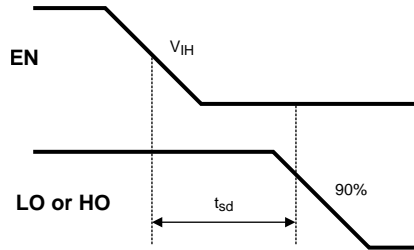
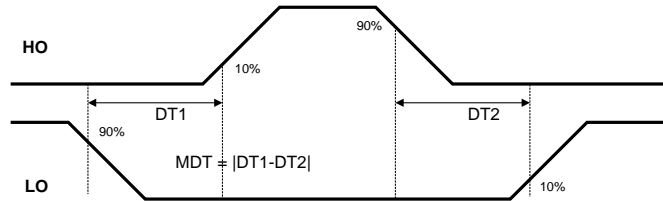
## STARTUP AND UVLO

Both top and bottom drivers include under-voltage lockout (UVLO) protection circuitry which monitors the supply voltage ( $V_{DD}$ ) and bootstrap capacitor voltage ( $HB - HS$ ) independently. The UVLO circuit inhibits each driver until sufficient supply voltage is available to turn-on the external MOSFETs, and the UVLO hysteresis prevents chattering during supply voltage transitions. When the supply voltage is applied to the  $V_{DD}$  pin of the LM5106, the top and bottom gates are held low until  $V_{DD}$  exceeds the UVLO threshold, typically about 6.9V. Any UVLO condition on the bootstrap capacitor will disable only the high side output (HO).

## LAYOUT CONSIDERATIONS

The optimum performance of high and low side gate drivers cannot be achieved without taking due considerations during circuit board layout. The following points are emphasized:

1. Low ESR / ESL capacitors must be connected close to the IC between  $V_{DD}$  and  $V_{SS}$  pins and between  $HB$  and  $HS$  pins to support high peak currents being drawn from  $V_{DD}$  and  $HB$  during the turn-on of the external MOSFETs.
2. To prevent large voltage transients at the drain of the top MOSFET, a low ESR electrolytic capacitor and a good quality ceramic capacitor must be connected between the MOSFET drain and ground ( $V_{SS}$ ).
3. In order to avoid large negative transients on the switch node ( $HS$ ) pin, the parasitic inductances between the source of the top MOSFET and the drain of the bottom MOSFET (synchronous rectifier) must be minimized.
4. Grounding considerations:
  - The first priority in designing grounding connections is to confine the high peak currents that charge and discharge the MOSFET gates to a minimal physical area. This will decrease the loop inductance and minimize noise issues on the gate terminals of the MOSFETs. The gate driver should be placed as close as possible to the MOSFETs.
  - The second consideration is the high current path that includes the bootstrap capacitor, the bootstrap diode, the local ground referenced bypass capacitor, and the low side MOSFET body diode. The bootstrap capacitor is recharged on a cycle-by-cycle basis through the bootstrap diode from the ground referenced  $V_{DD}$  bypass capacitor. The recharging occurs in a short time interval and involves high peak current. Minimizing this loop length and area on the circuit board is important to ensure reliable operation.
5. The resistor on the RDT pin must be placed very close to the IC and separated from the high current paths to avoid noise coupling to the time delay generator which could disrupt timer operation.



## POWER DISSIPATION CONSIDERATIONS

The total IC power dissipation is the sum of the gate driver losses and the bootstrap diode losses. The gate driver losses are related to the switching frequency ( $f$ ), output load capacitance on LO and HO ( $C_L$ ), and supply voltage ( $V_{DD}$ ) and can be roughly calculated as:

$$P_{DGATES} = 2 \cdot f \cdot C_L \cdot V_{DD}^2 \quad (1)$$

There are some additional losses in the gate drivers due to the internal CMOS stages used to buffer the LO and HO outputs. The following plot shows the measured gate driver power dissipation versus frequency and load capacitance. At higher frequencies and load capacitance values, the power dissipation is dominated by the power losses driving the output loads and agrees well with the above equation. This plot can be used to approximate the power losses due to the gate drivers.

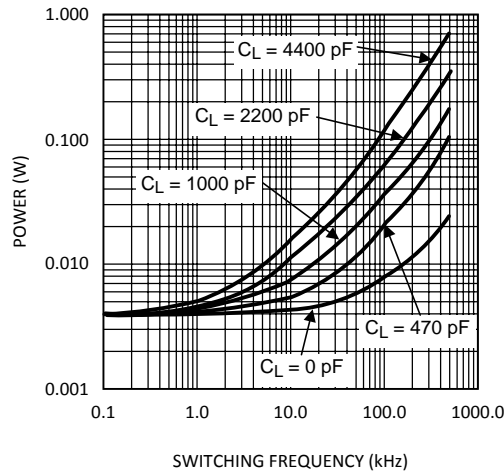

**Figure 20. Gate Driver Power Dissipation (LO + HO)**  
 $V_{CC} = 12V$

## HS TRANSIENT VOLTAGES BELOW GROUND

The HS node will always be clamped by the body diode of the lower external FET. In some situations, board resistances and inductances can cause the HS node to transiently swing several volts below ground. The HS node can swing below ground provided:

1. HS must always be at a lower potential than HO. Pulling HO more than -0.3V below HS can activate parasitic transistors resulting in excessive current flow from the HB supply, possibly resulting in damage to the IC. The same relationship is true with LO and VSS. If necessary, a Schottky diode can be placed externally between HO and HS or LO and GND to protect the IC from this type of transient. The diode must be placed as close to the IC pins as possible in order to be effective.
2. HB to HS operating voltage should be 15V or less. Hence, if the HS pin transient voltage is -5V, VDD should be ideally limited to 10V to keep HB to HS below 15V.
3. Low ESR bypass capacitors from HB to HS and from VCC to VSS are essential for proper operation. The capacitor should be located at the leads of the IC to minimize series inductance. The peak currents from LO and HO can be quite large. Any inductances in series with the bypass capacitor will cause voltage ringing at the leads of the IC which must be avoided for reliable operation.

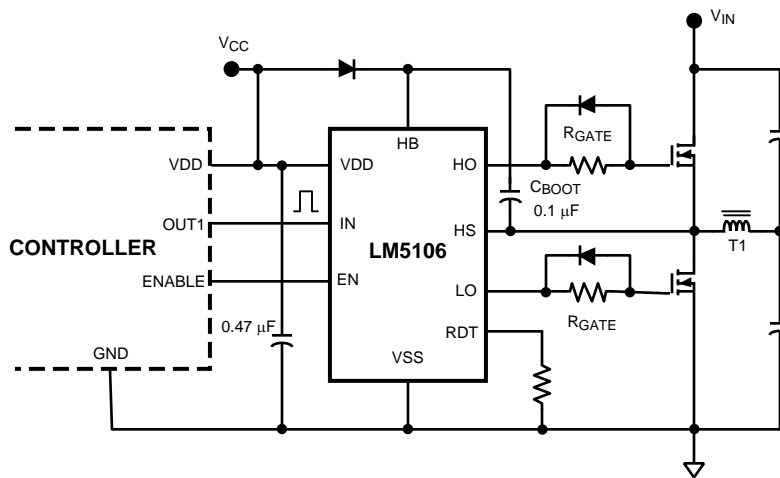

Figure 21. LM5106 Driving MOSFETs Connected in Half-Bridge Configuration

---

**REVISION HISTORY**

<b>Changes from Revision B (March 2013) to Revision C</b>	<b>Page</b>
• Changed layout of National Data Sheet to TI format .....	<a href="#">10</a>

---

**PACKAGING INFORMATION**

Orderable Device	Status (1)	Package Type	Package Drawing	Pins	Package Qty	Eco Plan (2)	Lead/Ball Finish	MSL Peak Temp (3)	Op Temp (°C)	Device Marking (4/5)	Samples
LM5106MM	ACTIVE	VSSOP	DGS	10	1000	TBD	Call TI	Call TI	-40 to 125	5106	<a href="#">Samples</a>
LM5106MM/NOPB	ACTIVE	VSSOP	DGS	10	1000	Green (RoHS & no Sb/Br)	CU SN	Level-1-260C-UNLIM	-40 to 125	5106	<a href="#">Samples</a>
LM5106MMX	ACTIVE	VSSOP	DGS	10		TBD	Call TI	Call TI	-40 to 125	5106	<a href="#">Samples</a>
LM5106MMX/NOPB	ACTIVE	VSSOP	DGS	10	3500	Green (RoHS & no Sb/Br)	CU SN	Level-1-260C-UNLIM	-40 to 125	5106	<a href="#">Samples</a>
LM5106SD	ACTIVE	WSON	DPR	10		TBD	Call TI	Call TI	-40 to 125	L5106SD	<a href="#">Samples</a>
LM5106SD/NOPB	ACTIVE	WSON	DPR	10	1000	Green (RoHS & no Sb/Br)	SN	Level-1-260C-UNLIM	-40 to 125	L5106SD	<a href="#">Samples</a>
LM5106SDX	ACTIVE	WSON	DPR	10		TBD	Call TI	Call TI	-40 to 125	L5106SD	<a href="#">Samples</a>
LM5106SDX/NOPB	ACTIVE	WSON	DPR	10	4500	Green (RoHS & no Sb/Br)	SN	Level-1-260C-UNLIM	-40 to 125	L5106SD	<a href="#">Samples</a>

(1) The marketing status values are defined as follows:

**ACTIVE:** Product device recommended for new designs.

**LIFEBUY:** TI has announced that the device will be discontinued, and a lifetime-buy period is in effect.

**NRND:** Not recommended for new designs. Device is in production to support existing customers, but TI does not recommend using this part in a new design.

**PREVIEW:** Device has been announced but is not in production. Samples may or may not be available.

**OBSOLETE:** TI has discontinued the production of the device.

(2) Eco Plan - The planned eco-friendly classification: Pb-Free (RoHS), Pb-Free (RoHS Exempt), or Green (RoHS & no Sb/Br) - please check <http://www.ti.com/productcontent> for the latest availability information and additional product content details.

**TBD:** The Pb-Free/Green conversion plan has not been defined.

**Pb-Free (RoHS):** TI's terms "Lead-Free" or "Pb-Free" mean semiconductor products that are compatible with the current RoHS requirements for all 6 substances, including the requirement that lead not exceed 0.1% by weight in homogeneous materials. Where designed to be soldered at high temperatures, TI Pb-Free products are suitable for use in specified lead-free processes.

**Pb-Free (RoHS Exempt):** This component has a RoHS exemption for either 1) lead-based flip-chip solder bumps used between the die and package, or 2) lead-based die adhesive used between the die and leadframe. The component is otherwise considered Pb-Free (RoHS compatible) as defined above.

**Green (RoHS & no Sb/Br):** TI defines "Green" to mean Pb-Free (RoHS compatible), and free of Bromine (Br) and Antimony (Sb) based flame retardants (Br or Sb do not exceed 0.1% by weight in homogeneous material)

(3) MSL, Peak Temp. -- The Moisture Sensitivity Level rating according to the JEDEC industry standard classifications, and peak solder temperature.

(4) There may be additional marking, which relates to the logo, the lot trace code information, or the environmental category on the device.

<sup>(5)</sup> Multiple Device Markings will be inside parentheses. Only one Device Marking contained in parentheses and separated by a "~" will appear on a device. If a line is indented then it is a continuation of the previous line and the two combined represent the entire Device Marking for that device.

**Important Information and Disclaimer:** The information provided on this page represents TI's knowledge and belief as of the date that it is provided. TI bases its knowledge and belief on information provided by third parties, and makes no representation or warranty as to the accuracy of such information. Efforts are underway to better integrate information from third parties. TI has taken and continues to take reasonable steps to provide representative and accurate information but may not have conducted destructive testing or chemical analysis on incoming materials and chemicals. TI and TI suppliers consider certain information to be proprietary, and thus CAS numbers and other limited information may not be available for release.

In no event shall TI's liability arising out of such information exceed the total purchase price of the TI part(s) at issue in this document sold by TI to Customer on an annual basis.

**TAPE AND REEL INFORMATION**

**QUADRANT ASSIGNMENTS FOR PIN 1 ORIENTATION IN TAPE**

\*All dimensions are nominal

Device	Package Type	Package Drawing	Pins	SPQ	Reel Diameter (mm)	Reel Width W1 (mm)	A0 (mm)	B0 (mm)	K0 (mm)	P1 (mm)	W (mm)	Pin1 Quadrant
LM5106MM	VSSOP	DGS	10	1000	178.0	12.4	5.3	3.4	1.4	8.0	12.0	Q1
LM5106MM/NOPB	VSSOP	DGS	10	1000	178.0	12.4	5.3	3.4	1.4	8.0	12.0	Q1
LM5106MMX/NOPB	VSSOP	DGS	10	3500	330.0	12.4	5.3	3.4	1.4	8.0	12.0	Q1
LM5106SD/NOPB	WSON	DPR	10	1000	178.0	12.4	4.3	4.3	1.3	8.0	12.0	Q1
LM5106SDX/NOPB	WSON	DPR	10	4500	330.0	12.4	4.3	4.3	1.3	8.0	12.0	Q1

## TAPE AND REEL BOX DIMENSIONS



\*All dimensions are nominal

Device	Package Type	Package Drawing	Pins	SPQ	Length (mm)	Width (mm)	Height (mm)
LM5106MM	VSSOP	DGS	10	1000	210.0	185.0	35.0
LM5106MM/NOPB	VSSOP	DGS	10	1000	210.0	185.0	35.0
LM5106MMX/NOPB	VSSOP	DGS	10	3500	367.0	367.0	35.0
LM5106SD/NOPB	WSON	DPR	10	1000	210.0	185.0	35.0
LM5106SDX/NOPB	WSON	DPR	10	4500	367.0	367.0	35.0

DGS (S-PDSO-G10)

PLASTIC SMALL-OUTLINE PACKAGE

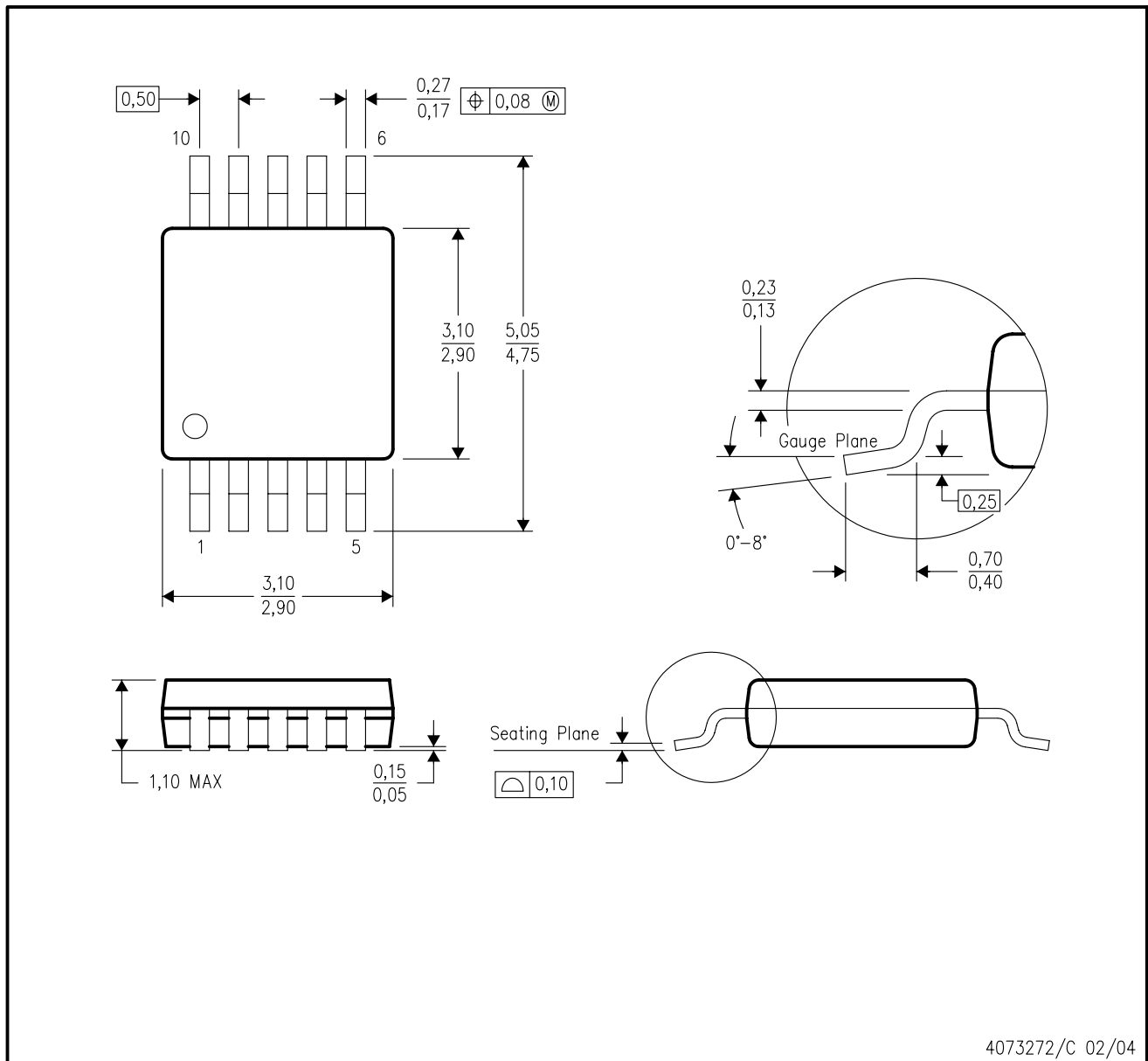

4073272/C 02/04

- NOTES:
- A. All linear dimensions are in millimeters.
  - B. This drawing is subject to change without notice.
  - C. Body dimensions do not include mold flash or protrusion.
  - D. Falls within JEDEC MO-187 variation BA.





## IMPORTANT NOTICE

Texas Instruments Incorporated and its subsidiaries (TI) reserve the right to make corrections, enhancements, improvements and other changes to its semiconductor products and services per JESD46, latest issue, and to discontinue any product or service per JESD48, latest issue. Buyers should obtain the latest relevant information before placing orders and should verify that such information is current and complete. All semiconductor products (also referred to herein as "components") are sold subject to TI's terms and conditions of sale supplied at the time of order acknowledgment.

TI warrants performance of its components to the specifications applicable at the time of sale, in accordance with the warranty in TI's terms and conditions of sale of semiconductor products. Testing and other quality control techniques are used to the extent TI deems necessary to support this warranty. Except where mandated by applicable law, testing of all parameters of each component is not necessarily performed.

TI assumes no liability for applications assistance or the design of Buyers' products. Buyers are responsible for their products and applications using TI components. To minimize the risks associated with Buyers' products and applications, Buyers should provide adequate design and operating safeguards.

TI does not warrant or represent that any license, either express or implied, is granted under any patent right, copyright, mask work right, or other intellectual property right relating to any combination, machine, or process in which TI components or services are used. Information published by TI regarding third-party products or services does not constitute a license to use such products or services or a warranty or endorsement thereof. Use of such information may require a license from a third party under the patents or other intellectual property of the third party, or a license from TI under the patents or other intellectual property of TI.

Reproduction of significant portions of TI information in TI data books or data sheets is permissible only if reproduction is without alteration and is accompanied by all associated warranties, conditions, limitations, and notices. TI is not responsible or liable for such altered documentation. Information of third parties may be subject to additional restrictions.

Resale of TI components or services with statements different from or beyond the parameters stated by TI for that component or service voids all express and any implied warranties for the associated TI component or service and is an unfair and deceptive business practice. TI is not responsible or liable for any such statements.

Buyer acknowledges and agrees that it is solely responsible for compliance with all legal, regulatory and safety-related requirements concerning its products, and any use of TI components in its applications, notwithstanding any applications-related information or support that may be provided by TI. Buyer represents and agrees that it has all the necessary expertise to create and implement safeguards which anticipate dangerous consequences of failures, monitor failures and their consequences, lessen the likelihood of failures that might cause harm and take appropriate remedial actions. Buyer will fully indemnify TI and its representatives against any damages arising out of the use of any TI components in safety-critical applications.

In some cases, TI components may be promoted specifically to facilitate safety-related applications. With such components, TI's goal is to help enable customers to design and create their own end-product solutions that meet applicable functional safety standards and requirements. Nonetheless, such components are subject to these terms.

No TI components are authorized for use in FDA Class III (or similar life-critical medical equipment) unless authorized officers of the parties have executed a special agreement specifically governing such use.

Only those TI components which TI has specifically designated as military grade or "enhanced plastic" are designed and intended for use in military/aerospace applications or environments. Buyer acknowledges and agrees that any military or aerospace use of TI components which have **not** been so designated is solely at the Buyer's risk, and that Buyer is solely responsible for compliance with all legal and regulatory requirements in connection with such use.

TI has specifically designated certain components as meeting ISO/TS16949 requirements, mainly for automotive use. In any case of use of non-designated products, TI will not be responsible for any failure to meet ISO/TS16949.

### Products

Audio	<a href="http://www.ti.com/audio">www.ti.com/audio</a>
Amplifiers	<a href="http://amplifier.ti.com">amplifier.ti.com</a>
Data Converters	<a href="http://dataconverter.ti.com">dataconverter.ti.com</a>
DLP® Products	<a href="http://www.dlp.com">www.dlp.com</a>
DSP	<a href="http://dsp.ti.com">dsp.ti.com</a>
Clocks and Timers	<a href="http://www.ti.com/clocks">www.ti.com/clocks</a>
Interface	<a href="http://interface.ti.com">interface.ti.com</a>
Logic	<a href="http://logic.ti.com">logic.ti.com</a>
Power Mgmt	<a href="http://power.ti.com">power.ti.com</a>
Microcontrollers	<a href="http://microcontroller.ti.com">microcontroller.ti.com</a>
RFID	<a href="http://www.ti-rfid.com">www.ti-rfid.com</a>
OMAP Applications Processors	<a href="http://www.ti.com/omap">www.ti.com/omap</a>
Wireless Connectivity	<a href="http://www.ti.com/wirelessconnectivity">www.ti.com/wirelessconnectivity</a>

### Applications

Automotive and Transportation	<a href="http://www.ti.com/automotive">www.ti.com/automotive</a>
Communications and Telecom	<a href="http://www.ti.com/communications">www.ti.com/communications</a>
Computers and Peripherals	<a href="http://www.ti.com/computers">www.ti.com/computers</a>
Consumer Electronics	<a href="http://www.ti.com/consumer-apps">www.ti.com/consumer-apps</a>
Energy and Lighting	<a href="http://www.ti.com/energy">www.ti.com/energy</a>
Industrial	<a href="http://www.ti.com/industrial">www.ti.com/industrial</a>
Medical	<a href="http://www.ti.com/medical">www.ti.com/medical</a>
Security	<a href="http://www.ti.com/security">www.ti.com/security</a>
Space, Avionics and Defense	<a href="http://www.ti.com/space-avionics-defense">www.ti.com/space-avionics-defense</a>
Video and Imaging	<a href="http://www.ti.com/video">www.ti.com/video</a>

### TI E2E Community

[e2e.ti.com](http://e2e.ti.com)