

# CSD86336Q3D Synchronous Buck NexFET™ Power Block

## 1 Features

- Half-Bridge Power Block
- 93.0% System Efficiency at 12 A
- Up to 20-A Operation
- High-Frequency Operation (up to 1.5 MHz)
- High-Density SON 3.3-mm x 3.3-mm Footprint
- Optimized for 5-V Gate Drive
- Low-Switching Losses
- Ultra-Low-Inductance Package
- RoHS Compliant
- Halogen Free
- Lead-Free Terminal Plating

## 2 Applications

- Synchronous Buck Converters
  - High-Frequency Applications
  - High-Current, Low-Duty Cycle Applications
- Multiphase Synchronous Buck Converters
- POL DC-DC Converters
- IMVP, VRM, and VRD Applications

## 3 Description

The CSD86336Q3D NexFET™ power block is an optimized design for synchronous buck applications offering high-current, high-efficiency, and high-frequency capability in a small 3.3-mm x 3.3-mm outline. Optimized for 5-V gate drive applications, this product offers a flexible solution capable of providing a high-density power supply when paired with any 5-V gate drive from an external controller/driver.

Top View

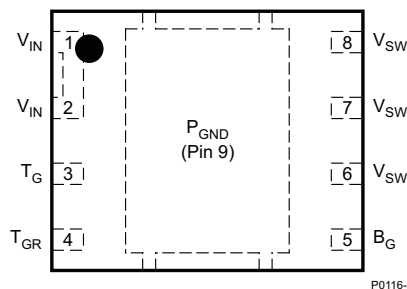

Device Information<sup>(1)</sup>

DEVICE	MEDIA	QTY	PACKAGE	SHIP
CSD86336Q3D	13-Inch Reel	2500	SON 3.30-mm x 3.30-mm	Tape and Reel
CSD86336Q3DT	7-Inch Reel	250	Plastic Package	Reel

(1) For all available packages, see the orderable addendum at the end of the data sheet.

Typical Circuit

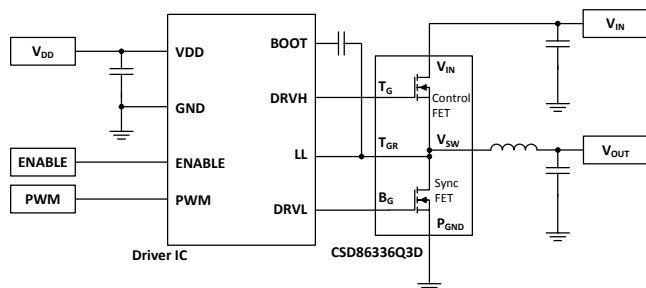

Copyright © 2017, Texas Instruments Incorporated

Typical Power Block Efficiency and Power Loss

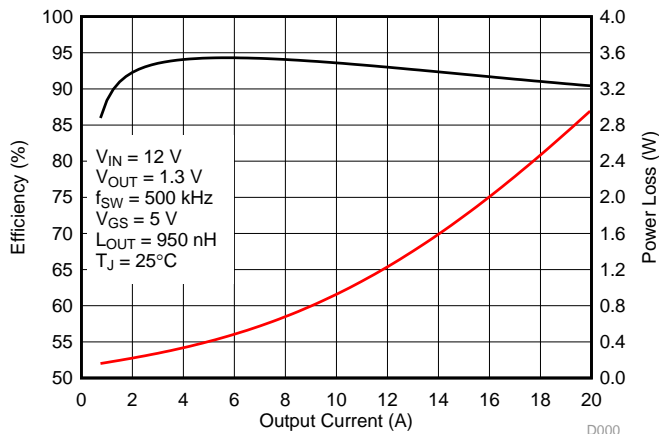

## Table of Contents

<b>1 Features</b> .....	<b>1</b>	6.4 Normalized Curves.....	<b>13</b>
<b>2 Applications</b> .....	<b>1</b>	6.5 Calculating Power Loss and Safe Operating Area (SOA) .....	<b>14</b>
<b>3 Description</b> .....	<b>1</b>	<b>7 Layout</b> .....	<b>16</b>
<b>4 Revision History</b> .....	<b>2</b>	7.1 Recommended Schematic Overview .....	<b>16</b>
<b>5 Specifications</b> .....	<b>3</b>	7.2 Recommended PCB Design Overview .....	<b>17</b>
5.1 Absolute Maximum Ratings .....	<b>3</b>	<b>8 Device and Documentation Support</b> .....	<b>19</b>
5.2 Recommended Operating Conditions.....	<b>3</b>	8.1 Receiving Notification of Documentation Updates..	<b>19</b>
5.3 Thermal Information .....	<b>3</b>	8.2 Community Resources.....	<b>19</b>
5.4 Power Block Performance .....	<b>3</b>	8.3 Trademarks .....	<b>19</b>
5.5 Electrical Characteristics – Q1 Control FET .....	<b>4</b>	8.4 Electrostatic Discharge Caution .....	<b>19</b>
5.6 Electrical Characteristics – Q2 Sync FET .....	<b>5</b>	8.5 Glossary .....	<b>19</b>
5.7 Typical Power Block Device Characteristics.....	<b>6</b>	<b>9 Mechanical, Packaging, and Orderable Information</b> .....	<b>20</b>
5.8 Typical Power Block MOSFET Characteristics.....	<b>8</b>	9.1 Q3D Package Dimensions.....	<b>20</b>
<b>6 Application and Implementation</b> .....	<b>11</b>	9.2 Pin Configuration.....	<b>20</b>
6.1 Application Information.....	<b>11</b>	9.3 Land Pattern Recommendation .....	<b>21</b>
6.2 Power Loss Curves .....	<b>13</b>	9.4 Stencil Recommendation .....	<b>22</b>
6.3 Safe Operating Area (SOA) Curves.....	<b>13</b>		

## 4 Revision History

DATE	REVISION	NOTES
March 2018	*	Initial release.

## 5 Specifications

### 5.1 Absolute Maximum Ratings

$T_A = 25^\circ\text{C}$  (unless otherwise noted)<sup>(1)</sup>

		MIN	MAX	UNIT
Voltage	$V_{IN}$ to $P_{GND}$		25	V
	$V_{SW}$ to $P_{GND}$		25	
	$V_{SW}$ to $P_{GND}$ (10 ns)		27	
	$T_G$ to $T_{GR}$	-8	10	
	$B_G$ to $P_{GND}$	-8	10	
Pulsed current rating, $IDM$ <sup>(2)</sup>			60	A
Power dissipation, $P_D$			6	W
Avalanche energy, $E_{AS}$	Sync FET, $I_D = 40$ A, $L = 0.1$ mH		80	mJ
	Control FET, $I_D = 26$ A, $L = 0.1$ mH		34	
$T_J$ and $T_{STG}$	Operating junction and storage temperature	-55	150	$^\circ\text{C}$

(1) Stresses beyond those listed under Absolute Maximum Ratings may cause permanent damage to the device. These are stress ratings only, and functional operation of the device at these or any other conditions beyond those indicated is not implied. Exposure to absolute-maximum-rated conditions for extended periods may affect device reliability.

(2) Pulse duration = 50  $\mu\text{s}$ . Duty cycle = 0.01.

### 5.2 Recommended Operating Conditions

$T_A = 25^\circ\text{C}$  (unless otherwise noted)

		MIN	MAX	UNIT
$V_{GS}$	Gate drive voltage	4.5	8	V
$V_{IN}$	Input supply voltage <sup>(1)</sup>		22	V
$f_{SW}$	Switching frequency $C_{BST} = 0.1$ $\mu\text{F}$ (min)		1500	kHz
	Operating current		20	A
$T_J$	Operating temperature		125	$^\circ\text{C}$
$T_{STG}$	Storage temperature		125	$^\circ\text{C}$

(1) Operating at high  $V_{IN}$  can create excessive AC voltage overshoots on the switch node ( $V_{SW}$ ) during MOSFET switching transients. For reliable operation, the switch node ( $V_{SW}$ ) to ground voltage must remain at or below the *Absolute Maximum Ratings*.

### 5.3 Thermal Information

$T_A = 25^\circ\text{C}$  (unless otherwise noted)

THERMAL METRIC		MIN	MAX	UNIT
$R_{\theta JA}$	Junction-to-ambient thermal resistance (min Cu) <sup>(1)</sup>		105	$^\circ\text{C}/\text{W}$
$R_{\theta JA}$	Junction-to-ambient thermal resistance (max Cu) <sup>(1) (2)</sup>		55	$^\circ\text{C}/\text{W}$
$R_{\theta JC}$	Junction-to-case thermal resistance (top of package) <sup>(1)</sup>		17	$^\circ\text{C}/\text{W}$
$R_{\theta JC}$	Junction-to-case thermal resistance ( $P_{GND}$ pin) <sup>(1)</sup>		3.2	$^\circ\text{C}/\text{W}$

(1)  $R_{\theta JC}$  is determined with the device mounted on a 1-in<sup>2</sup> (6.45-cm<sup>2</sup>), 2-oz (0.071-mm) thick Cu pad on a 1.5-in  $\times$  1.5-in (3.81-cm  $\times$  3.81-cm), 0.06-in (1.52-mm) thick FR4 board.  $R_{\theta JC}$  is specified by design while  $R_{\theta JA}$  is determined by the user's board design.

(2) Device mounted on FR4 material with 1-in<sup>2</sup> (6.45-cm<sup>2</sup>) Cu.

### 5.4 Power Block Performance

$T_A = 25^\circ\text{C}$  (unless otherwise noted)

PARAMETER	TEST CONDITIONS	MIN	TYP	MAX	UNIT
$P_{LOSS}$	Power loss <sup>(1)</sup>	$V_{IN} = 12$ V, $V_{GS} = 5$ V, $V_{OUT} = 1.3$ V, $I_{OUT} = 15$ A, $f_{SW} = 500$ kHz, $L_{OUT} = 950$ nH, $T_J = 25^\circ\text{C}$	1.8		W
$I_{QVIN}$	$V_{IN}$ quiescent current <sup>(1)</sup>	$T_G$ to $T_{GR} = 0$ V, $B_G$ to $P_{GND} = 0$ V, $V_{IN} = 12$ V	10		$\mu\text{A}$

(1) Measurement made with six 10- $\mu\text{F}$  (TDK C3216X5R1C106KT or equivalent) ceramic capacitors placed across  $V_{IN}$  to  $P_{GND}$  pins and using a high-current 5-V driver IC.

## 5.5 Electrical Characteristics – Q1 Control FET

 $T_j = 25\text{ }^\circ\text{C}$  (unless otherwise noted)

PARAMETER		TEST CONDITIONS	MIN	TYP	MAX	UNIT
<b>STATIC CHARACTERISTICS</b>						
$BV_{DSS}$	Drain-to-source voltage	$V_{GS} = 0\text{ V}, I_{DS} = 250\text{ }\mu\text{A}$	25			V
$I_{DSS}$	Drain-to-source leakage current	$V_{GS} = 0\text{ V}, V_{DS} = 20\text{ V}$			1	$\mu\text{A}$
$I_{GSS}$	Gate-to-source leakage current	$V_{DS} = 0\text{ V}, V_{GS} = +10 / -8\text{ V}$			100	nA
$V_{GS(th)}$	Gate-to-source threshold voltage	$V_{DS} = V_{GS}, I_{DS} = 250\text{ }\mu\text{A}$	1.1	1.5	1.9	V
$Z_{DS(on)}$	Effective AC on-impedance	$V_{IN} = 12\text{ V}, V_{GS} = 5\text{ V}, V_{OUT} = 1.3\text{ V},$ $I_{OUT} = 20\text{ A}, f_{SW} = 500\text{ kHz},$ $L_{OUT} = 950\text{ nH}$		9.1		m $\Omega$
$g_{fs}$	Transconductance	$V_{DS} = 2.5\text{ V}, I_{DS} = 14\text{ A}$		40		S
<b>DYNAMIC CHARACTERISTICS</b>						
$C_{ISS}$	Input capacitance	$V_{GS} = 0\text{ V}, V_{DS} = 12.5\text{ V}, f = 1\text{ Mhz}$		380	494	pF
$C_{OSS}$	Output capacitance			263	342	pF
$C_{RSS}$	Reverse transfer capacitance			14.1	18.3	pF
$R_G$	Series gate resistance			4.0	8.0	$\Omega$
$Q_g$	Gate charge total (4.5 V)	$V_{DS} = 12.5\text{ V}, I_{DS} = 14\text{ A}$		2.9	3.8	nC
$Q_{gd}$	Gate charge – gate-to-drain			0.6		nC
$Q_{gs}$	Gate charge – gate-to-source			1.4		nC
$Q_{g(th)}$	Gate charge at $V_{th}$			0.6		nC
$Q_{OSS}$	Output charge	$V_{DS} = 12.5\text{ V}, V_{GS} = 0\text{ V}$		5.4		nC
$t_{d(on)}$	Turn on delay time	$V_{DS} = 12.5\text{ V}, V_{GS} = 4.5\text{ V}, I_{DS} = 14\text{ A},$ $R_G = 0\text{ }\Omega$		5		ns
$t_r$	Rise time			10		ns
$t_{d(off)}$	Turn off delay time			7		ns
$t_f$	Fall time			2		ns
<b>DIODE CHARACTERISTICS</b>						
$V_{SD}$	Diode forward voltage	$I_{DS} = 14\text{ A}, V_{GS} = 0\text{ V}$		0.86	1.0	V
$Q_{rr}$	Reverse recovery charge	$V_{DS} = 12.5\text{ V}, I_F = 14\text{ A}, di/dt = 300\text{ A}/\mu\text{s}$		14.7		nC
$t_{rr}$	Reverse recovery time			15		ns

## 5.6 Electrical Characteristics – Q2 Sync FET

 $T_j = 25\text{ }^\circ\text{C}$  (unless otherwise noted)

PARAMETER		TEST CONDITIONS	MIN	TYP	MAX	UNIT
<b>STATIC CHARACTERISTICS</b>						
$V_{DSS}$	Drain-to-source voltage	$V_{GS} = 0\text{ V}, I_{DS} = 250\text{ }\mu\text{A}$	25			V
$I_{DSS}$	Drain-to-source leakage current	$V_{GS} = 0\text{ V}, V_{DS} = 20\text{ V}$			1	$\mu\text{A}$
$I_{GSS}$	Gate-to-source leakage current	$V_{DS} = 0\text{ V}, V_{GS} = +10 / -8\text{ V}$			100	nA
$V_{GS(th)}$	Gate-to-source threshold voltage	$V_{DS} = V_{GS}, I_{DS} = 250\text{ }\mu\text{A}$	1.0	1.3	1.6	V
$Z_{DS(on)}$	Effective AC on-impedance	$V_{IN} = 12\text{ V}, V_{GS} = 5\text{ V}, V_{OUT} = 1.3\text{ V},$ $I_{OUT} = 20\text{ A}, f_{SW} = 500\text{ kHz},$ $L_{OUT} = 950\text{ nH}$		3.4		m $\Omega$
$g_{fs}$	Transconductance	$V_{DS} = 2.5\text{ V}, I_{DS} = 14\text{ A}$		57		S
<b>DYNAMIC CHARACTERISTICS</b>						
$C_{ISS}$	Input capacitance	$V_{GS} = 0\text{ V}, V_{DS} = 12.5\text{ V}, f = 1\text{ Mhz}$		728	970	pF
$C_{OSS}$	Output capacitance			501	664	pF
$C_{RSS}$	Reverse transfer capacitance			26	33	pF
$R_G$	Series gate resistance		0.65	1.3		$\Omega$
$Q_g$	Gate charge total (4.5 V)	$V_{DS} = 12.5\text{ V}, I_{DS} = 14\text{ A}$		5.7	7.4	nC
$Q_{gd}$	Gate charge – gate-to-drain			1.2		nC
$Q_{gs}$	Gate charge – gate-to-source			2.1		nC
$Q_{g(th)}$	Gate charge at $V_{th}$			1.0		nC
$Q_{OSS}$	Output charge	$V_{DS} = 12.5\text{ V}, V_{GS} = 0\text{ V}$		10.3		nC
$t_{d(on)}$	Turn on delay time	$V_{DS} = 12.5\text{ V}, V_{GS} = 4.5\text{ V}, I_{DS} = 14\text{ A},$ $R_G = 0\text{ }\Omega$		4		ns
$t_r$	Rise time			10		ns
$t_{d(off)}$	Turn off delay time			8		ns
$t_f$	Fall time			2		ns
<b>DIODE CHARACTERISTICS</b>						
$V_{SD}$	Diode forward voltage	$I_{DS} = 14\text{ A}, V_{GS} = 0\text{ V}$	0.82	0.95		V
$Q_{rr}$	Reverse recovery charge	$V_{DS} = 12.5\text{ V}, I_F = 14\text{ A}, di/dt = 300\text{ A}/\mu\text{s}$		25.4		nC
$t_{rr}$	Reverse recovery time			18		ns

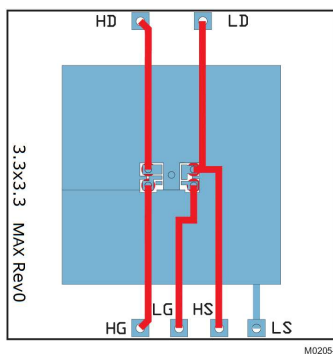

Max  $R_{\theta JA} = 55^\circ\text{C}/\text{W}$   
when mounted on 1 in<sup>2</sup>  
(6.45 cm<sup>2</sup>) of 2-oz  
(0.071-mm) thick Cu.

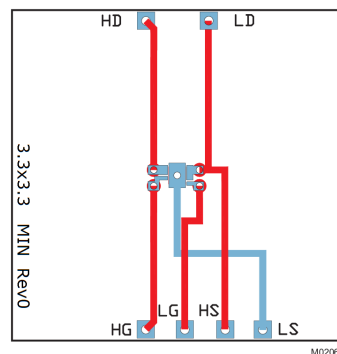

Max  $R_{\theta JA} = 105^\circ\text{C}/\text{W}$   
when mounted on  
minimum pad area of  
2-oz (0.071-mm) thick  
Cu.

### 5.7 Typical Power Block Device Characteristics

Test conditions:  $V_{IN} = 12\text{ V}$ ,  $V_{DD} = 5\text{ V}$ ,  $f_{SW} = 500\text{ kHz}$ ,  $V_{OUT} = 1.3\text{ V}$ ,  $L_{OUT} = 0.95\text{ }\mu\text{H}$ ,  $I_{OUT} = 20\text{ A}$ ,  $T_J = 125^\circ\text{C}$ , unless stated otherwise.

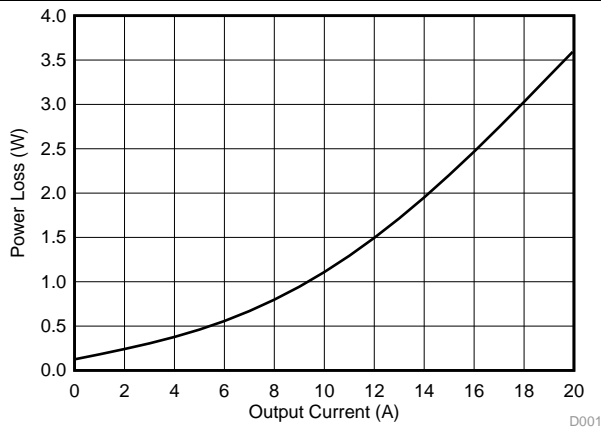

Figure 1. Power Loss vs Output Current

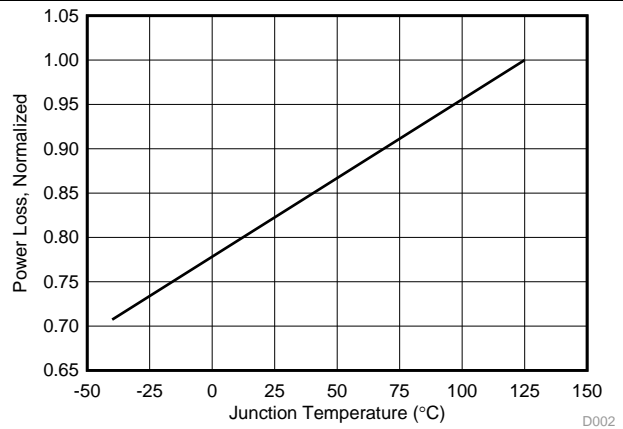

Figure 2. Power Loss vs Temperature

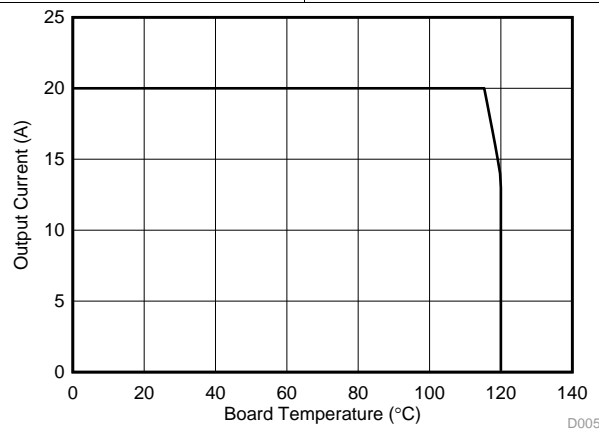
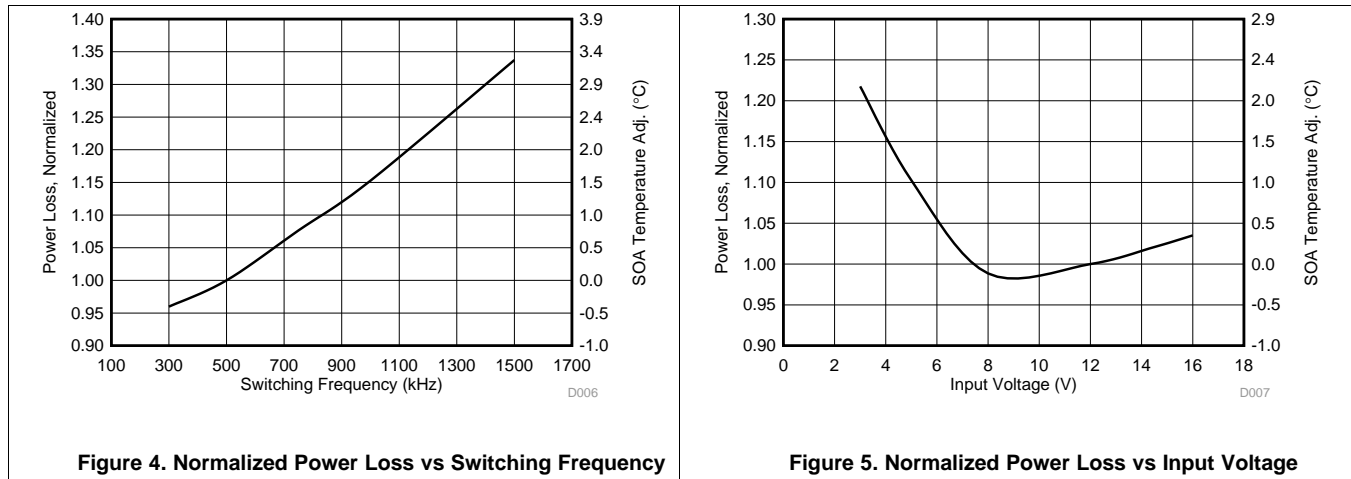

Figure 3. Typical Safe Operating Area (SOA) <sup>(1)</sup>

(1) The Typical Power Block System Characteristic curves are based on measurements made on a PCB design with dimensions of 4 in (W) × 3.5 in (L) × 0.062 in (H) and 6 copper layers of 1-oz copper thickness. See [Application and Implementation](#) section for detailed explanation.

**Typical Power Block Device Characteristics (continued)**

Test conditions:  $V_{IN} = 12\text{ V}$ ,  $V_{DD} = 5\text{ V}$ ,  $f_{SW} = 500\text{ kHz}$ ,  $V_{OUT} = 1.3\text{ V}$ ,  $L_{OUT} = 0.95\text{ }\mu\text{H}$ ,  $I_{OUT} = 20\text{ A}$ ,  $T_J = 125^\circ\text{C}$ , unless stated otherwise.



**Figure 4. Normalized Power Loss vs Switching Frequency**

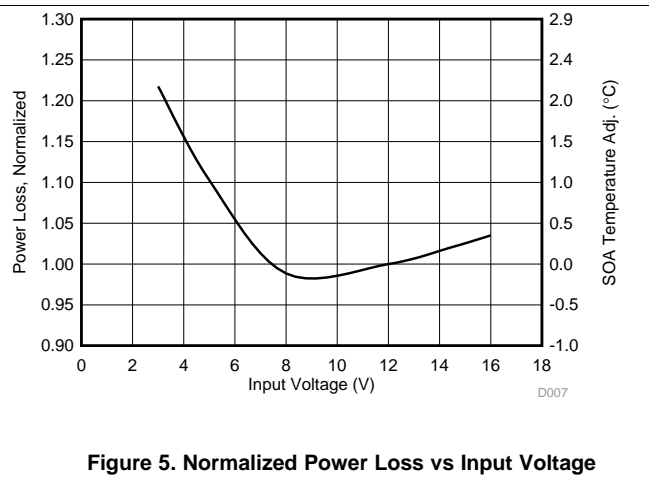

**Figure 5. Normalized Power Loss vs Input Voltage**

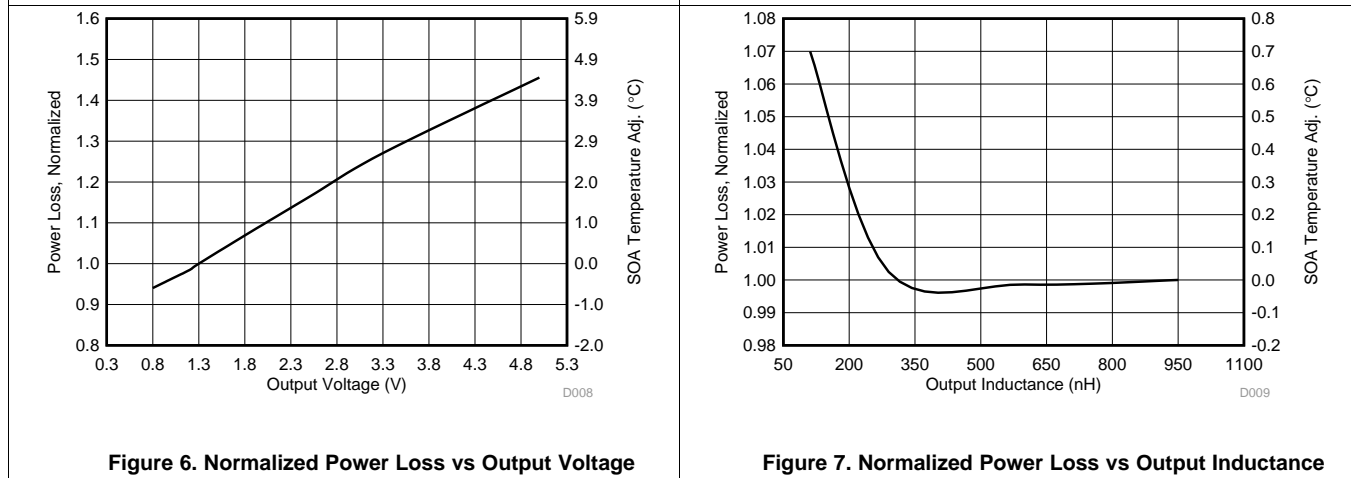

**Figure 6. Normalized Power Loss vs Output Voltage**

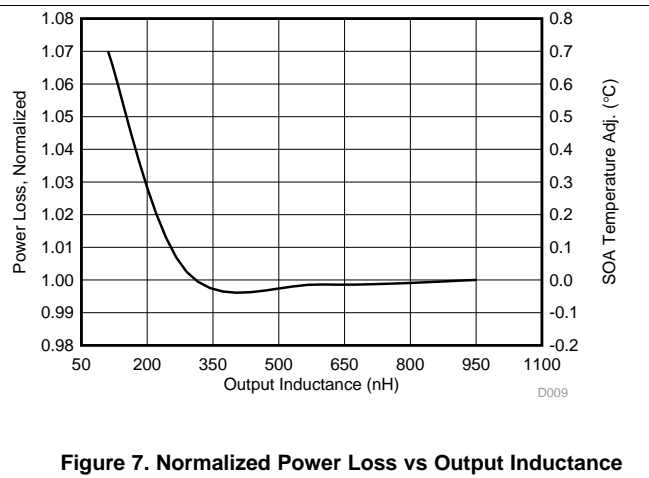

**Figure 7. Normalized Power Loss vs Output Inductance**

### 5.8 Typical Power Block MOSFET Characteristics

T<sub>A</sub> = 25°C, unless stated otherwise.

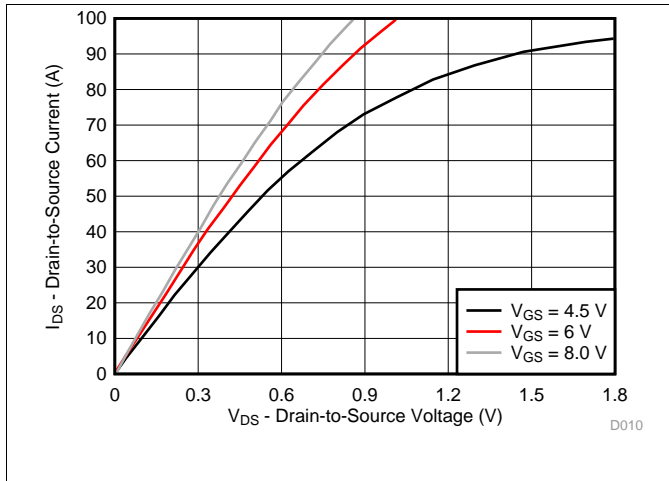

Figure 8. Control MOSFET Saturation

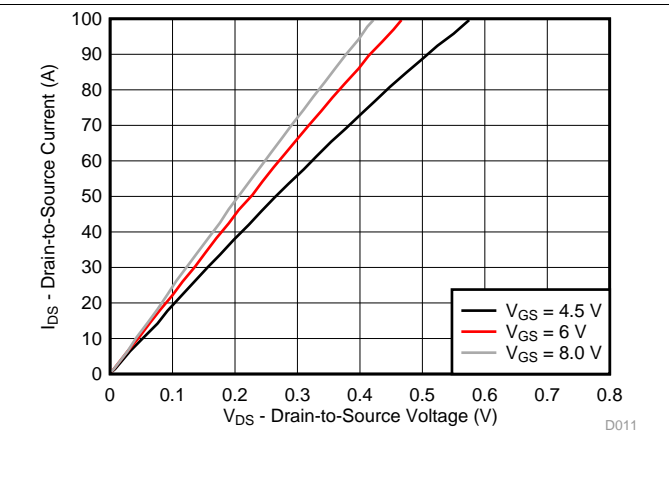

Figure 9. Sync MOSFET Saturation

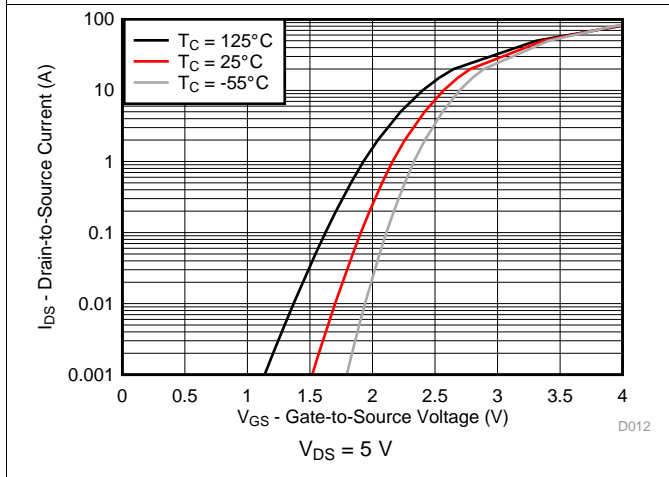

Figure 10. Control MOSFET Transfer

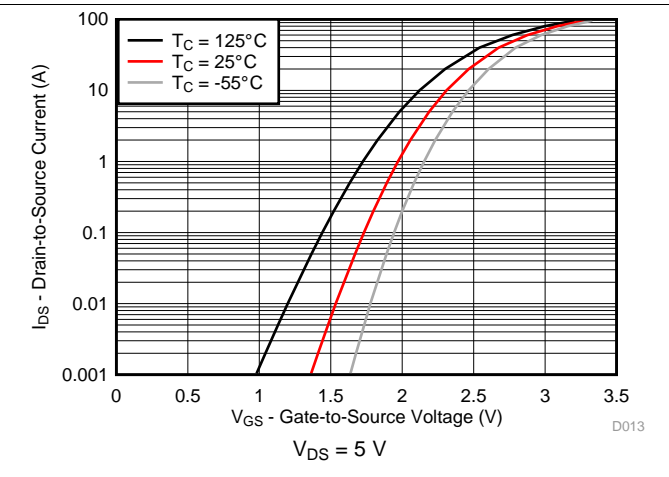

Figure 11. Sync MOSFET Transfer

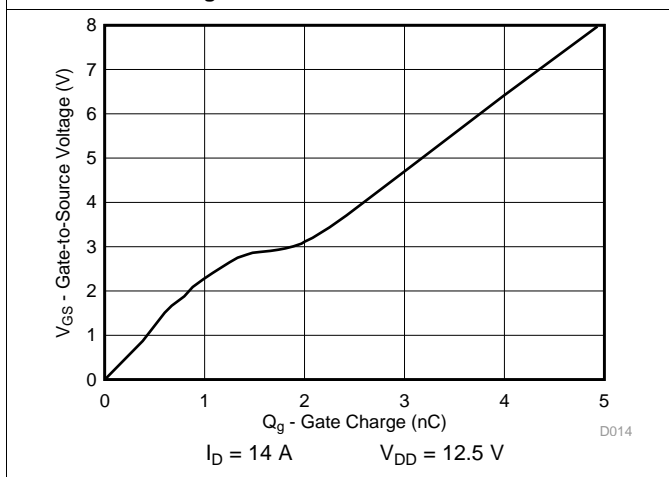

Figure 12. Control MOSFET Gate Charge

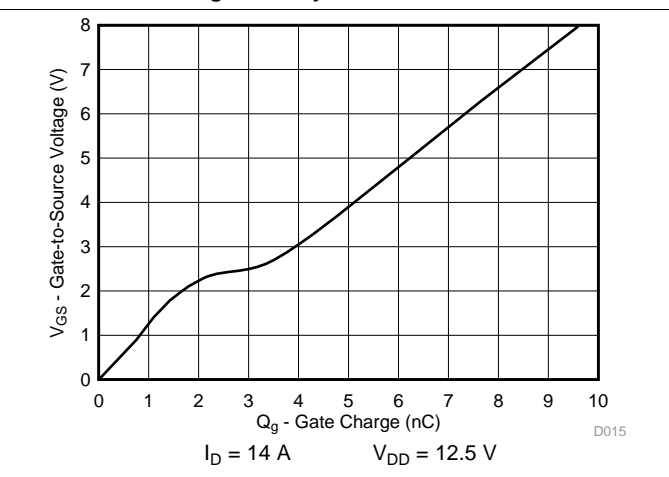
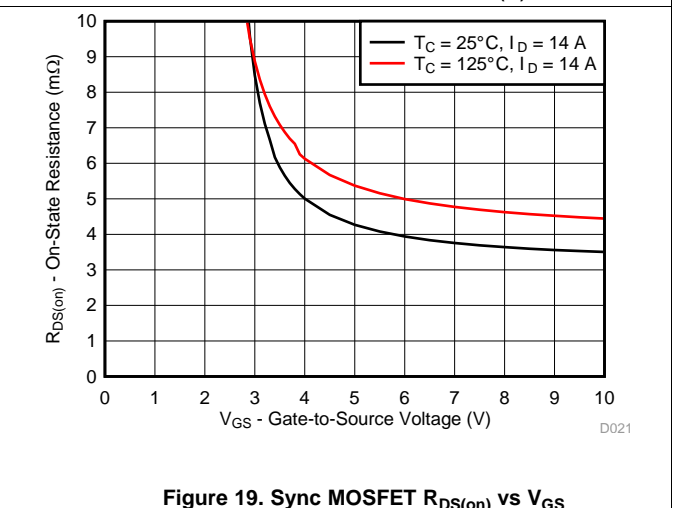
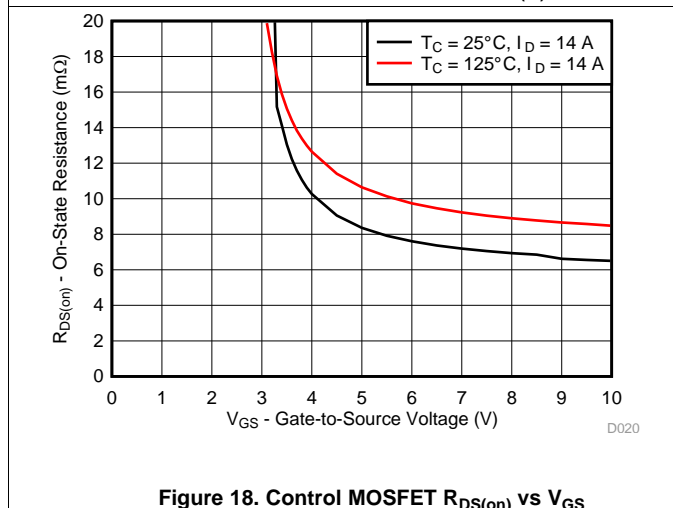
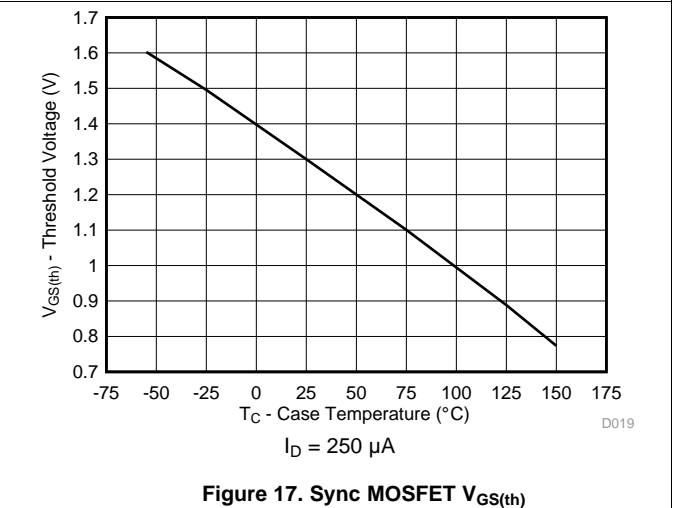
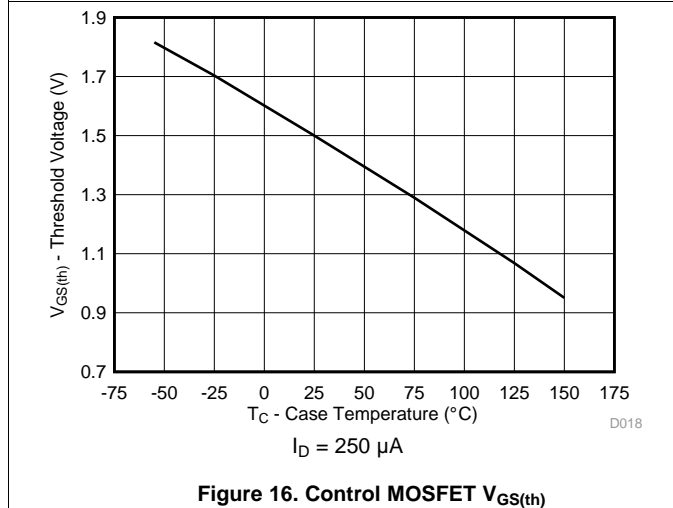
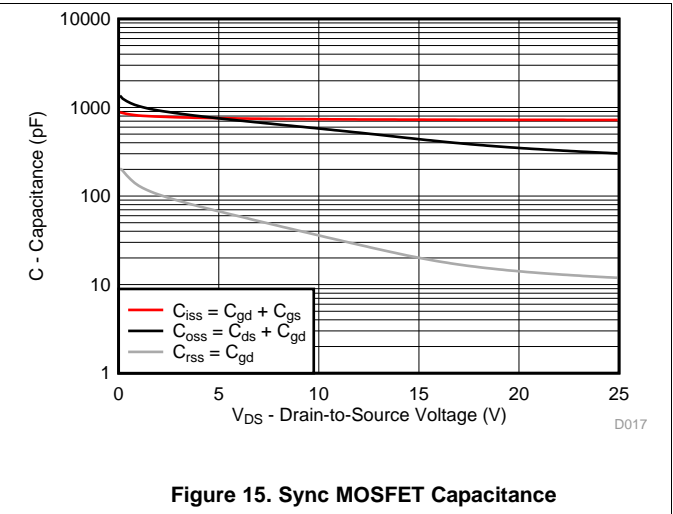
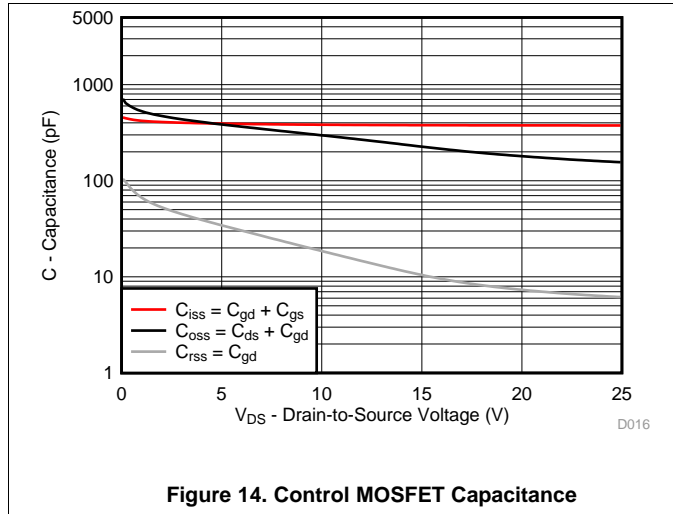

Figure 13. Sync MOSFET Gate Charge



Typical Power Block MOSFET Characteristics (continued)

T<sub>A</sub> = 25°C, unless stated otherwise.



### Typical Power Block MOSFET Characteristics (continued)

$T_A = 25^\circ\text{C}$ , unless stated otherwise.

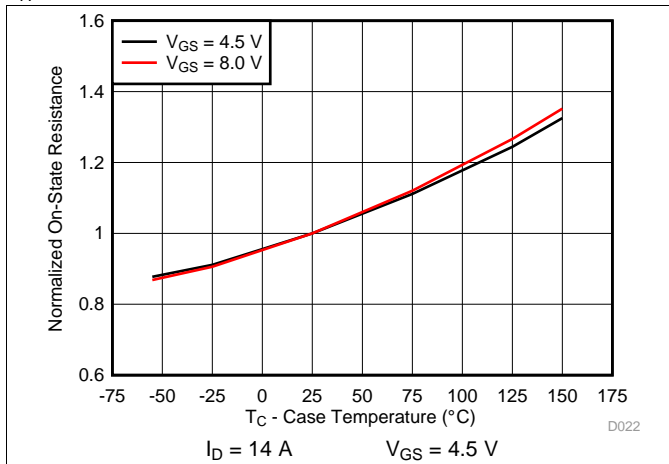

Figure 20. Control MOSFET Normalized  $R_{DS(on)}$

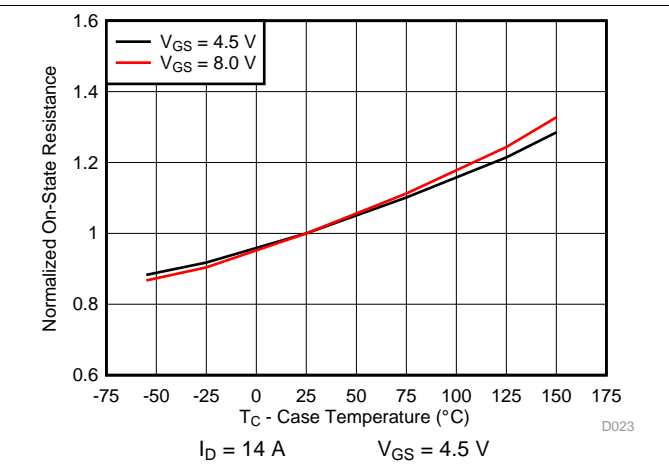

Figure 21. Sync MOSFET Normalized  $R_{DS(on)}$

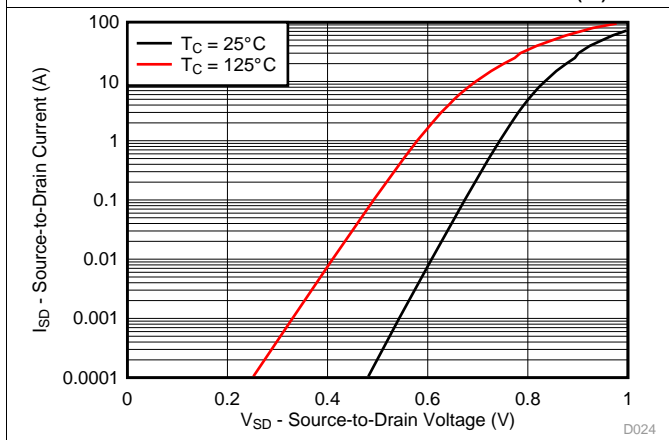

Figure 22. Control MOSFET Body Diode

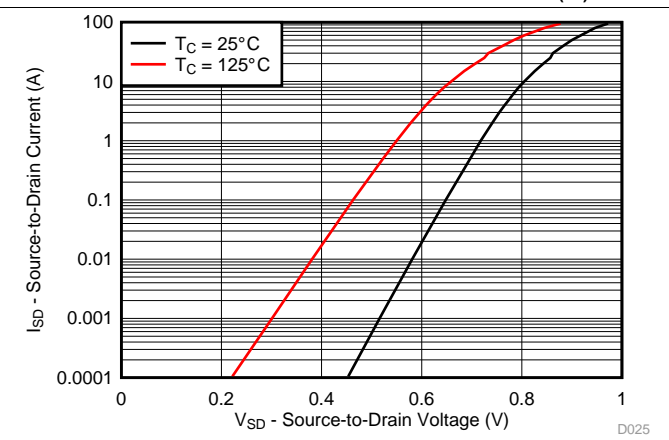

Figure 23. Sync MOSFET Body Diode

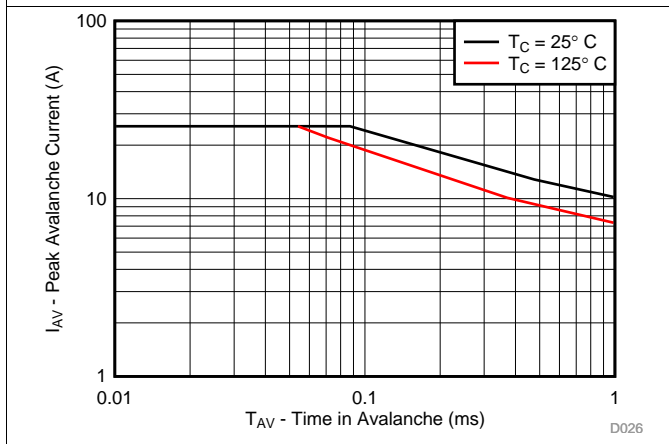

Figure 24. Control MOSFET Unclamped Inductive Switching

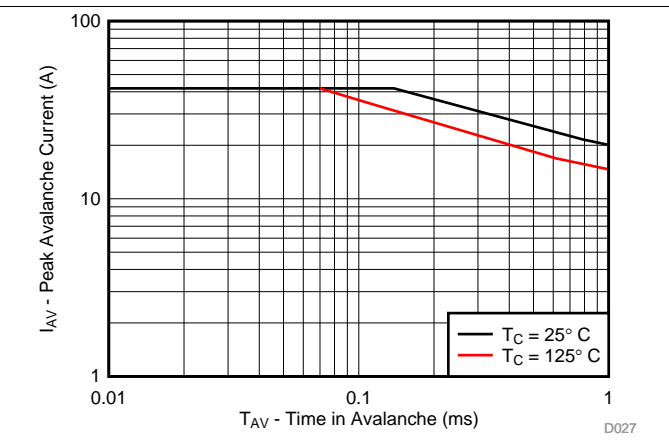

Figure 25. Sync MOSFET Unclamped Inductive Switching

## 6 Application and Implementation

### NOTE

Information in the following applications sections is not part of the TI component specification, and TI does not warrant its accuracy or completeness. TI's customers are responsible for determining suitability of components for their purposes. Customers should validate and test their design implementation to confirm system functionality.

### 6.1 Application Information

#### 6.1.1 Equivalent System Performance

Many of today's high-performance computing systems require low-power consumption in an effort to reduce system operating temperatures and improve overall system efficiency. This has created a major emphasis on improving the conversion efficiency of today's synchronous buck topology. In particular, there has been an emphasis in improving the performance of the critical power semiconductor in the power stage of this application (see Figure 26). As such, optimization of the power semiconductors in these applications, needs to go beyond simply reducing  $R_{DS(ON)}$ .

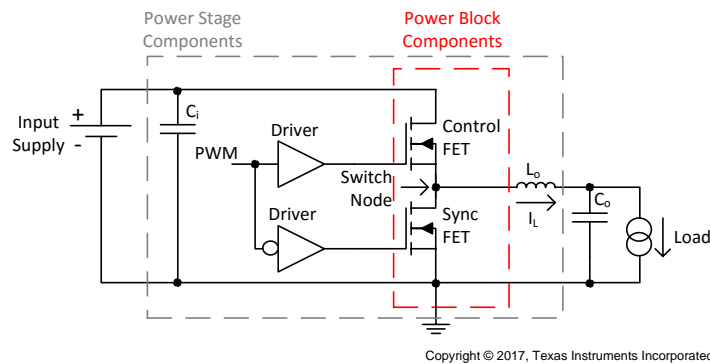

Figure 26. Synchronous Buck Topology

The CSD86336Q3D is part of TI's power block product family which is a highly optimized product for use in a synchronous buck topology requiring high current, high efficiency, and high frequency. It incorporates TI's latest generation silicon which has been optimized for switching performance, as well as minimizing losses associated with  $Q_{GD}$ ,  $Q_{GS}$ , and  $Q_{RR}$ . Furthermore, TI's patented packaging technology has minimized losses by nearly eliminating parasitic elements between the control FET and sync FET connections (see Figure 27). A key challenge solved by TI's patented packaging technology is the system level impact of Common Source Inductance (CSI). CSI greatly impedes the switching characteristics of any MOSFET which in turn increases switching losses and reduces system efficiency. As a result, the effects of CSI need to be considered during the MOSFET selection process. In addition, standard MOSFET switching loss equations used to predict system efficiency need to be modified in order to account for the effects of CSI. Further details behind the effects of CSI and modification of switching loss equations are outlined in [Power Loss Calculation With Common Source Inductance Consideration for Synchronous Buck Converters](#) (SLPA009).

Application Information (continued)

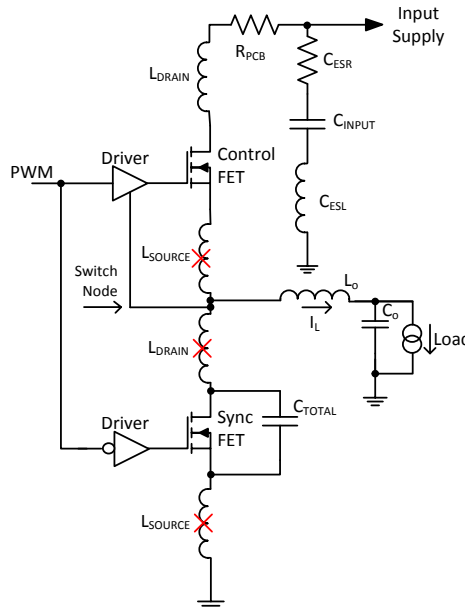

Figure 27. Elimination of Common Source Inductance

The combination of TI's latest generation silicon and optimized packaging technology has created a benchmarking solution that outperforms industry standard MOSFET chipsets of similar  $R_{DS(ON)}$  and MOSFET chipsets with lower  $R_{DS(ON)}$ . Figure 28 and Figure 29 compare the efficiency and power loss performance of the CSD86336Q3D versus industry standard MOSFET chipsets commonly used in this type of application. This comparison purely focuses on the efficiency and generated loss of the power semiconductors only. The performance of CSD86336Q3D clearly highlights the importance of considering the effective AC on-impedance ( $Z_{DS(ON)}$ ) during the MOSFET selection process of any new design. Simply normalizing to traditional MOSFET  $R_{DS(ON)}$  specifications is not an indicator of the actual in-circuit performance when using TI's power block technology.

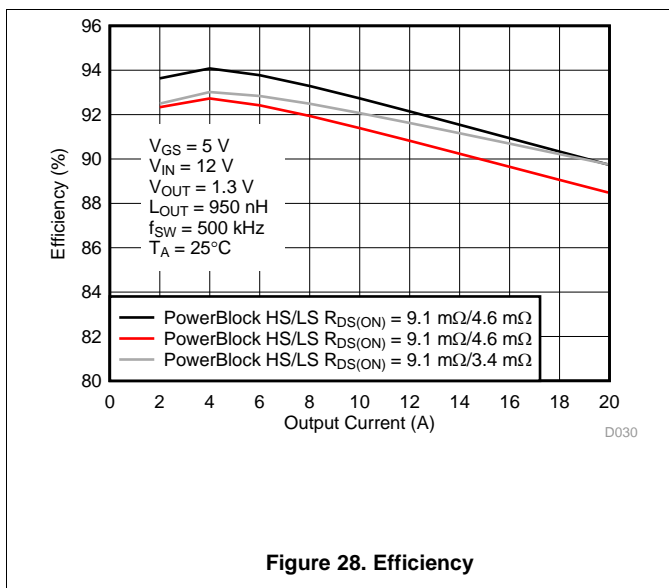

Figure 28. Efficiency

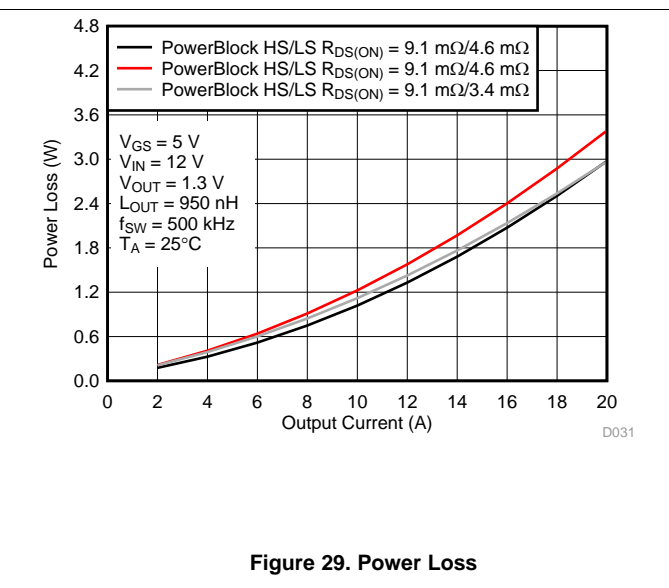

Figure 29. Power Loss

## Application Information (continued)

**Table 1** compares the traditional DC measured  $R_{DS(ON)}$  of CSD86336Q3D versus its  $Z_{DS(ON)}$ . This comparison takes into account the improved efficiency associated with TI's patented packaging technology. As such, when comparing TI's power block products to individually packaged discrete MOSFETs or dual MOSFETs in a standard package, the in-circuit switching performance of the solution must be considered. In this example, individually packaged discrete MOSFETs or dual MOSFETs in a standard package would need to have DC measured  $R_{DS(ON)}$  values that are equivalent to the  $Z_{DS(ON)}$  value of CSD86336Q3D in order to have the same efficiency performance at full load. Mid to light-load efficiency will still be lower with individually packaged discrete MOSFETs or dual MOSFETs in a standard package.

**Table 1. Comparison of  $R_{DS(ON)}$  vs  $Z_{DS(ON)}$**

PARAMETER	HS		LS	
	TYP	MAX	TYP	MAX
Effective AC on-impedance $Z_{DS(ON)}$ ( $V_{GS} = 5\text{ V}$ )	9.1	—	3.4	—
DC measured $R_{DS(ON)}$ ( $V_{GS} = 4.5\text{ V}$ )	9.1	11.4	4.6	5.7

The CSD86336Q3D NexFET™ power block is an optimized design for synchronous buck applications using 5-V gate drive. The control FET and sync FET silicon are parametrically tuned to yield the lowest power loss and highest system efficiency. As a result, a new rating method is needed which is tailored towards a more systems-centric environment. System-level performance curves such as power loss, safe operating area (SOA), and normalized graphs allow engineers to predict the product performance in the actual application.

### 6.2 Power Loss Curves

MOSFET centric parameters such as  $R_{DS(ON)}$  and  $Q_{gd}$  are needed to estimate the loss generated by the devices. In an effort to simplify the design process for engineers, Texas Instruments has provided measured power loss performance curves. **Figure 1** plots the power loss of the CSD86336Q3D as a function of load current. This curve is measured by configuring and running the CSD86336Q3D as it would be in the final application (see **Figure 30**). The measured power loss is the CSD86336Q3D loss and consists of both input conversion loss and gate drive loss. **Equation 1** is used to generate the power loss curve.

$$(V_{IN} \times I_{IN}) + (V_{DD} \times I_{DD}) - (V_{SW\_AVG} \times I_{OUT}) = \text{power loss} \quad (1)$$

The power loss curve in **Figure 1** is measured at the maximum recommended junction temperatures of 125°C under isothermal test conditions.

### 6.3 Safe Operating Area (SOA) Curves

The SOA curve in the CSD86336Q3D data sheet provides guidance on the temperature boundaries within an operating system by incorporating the thermal resistance and system power loss. **Figure 3** outlines the temperature conditions required for a given load current. The area under the curve dictates the safe operating area. All the curves are based on measurements made on a PCB design with dimensions of 4 in (W) × 3.5 in (L) × 0.062 in (T) and 6 copper layers of 1-oz copper thickness.

### 6.4 Normalized Curves

The normalized curves in the CSD86336Q3D data sheet provides guidance on the power loss and SOA adjustments based on their application specific needs. These curves show how the power loss and SOA boundaries will adjust for a given set of systems conditions. The primary Y-axis is the normalized change in power loss and the secondary Y-axis is the change in system temperature required in order to comply with the SOA curve. The change in power loss is a multiplier for the power loss curve and the change in temperature is subtracted from the SOA curve.

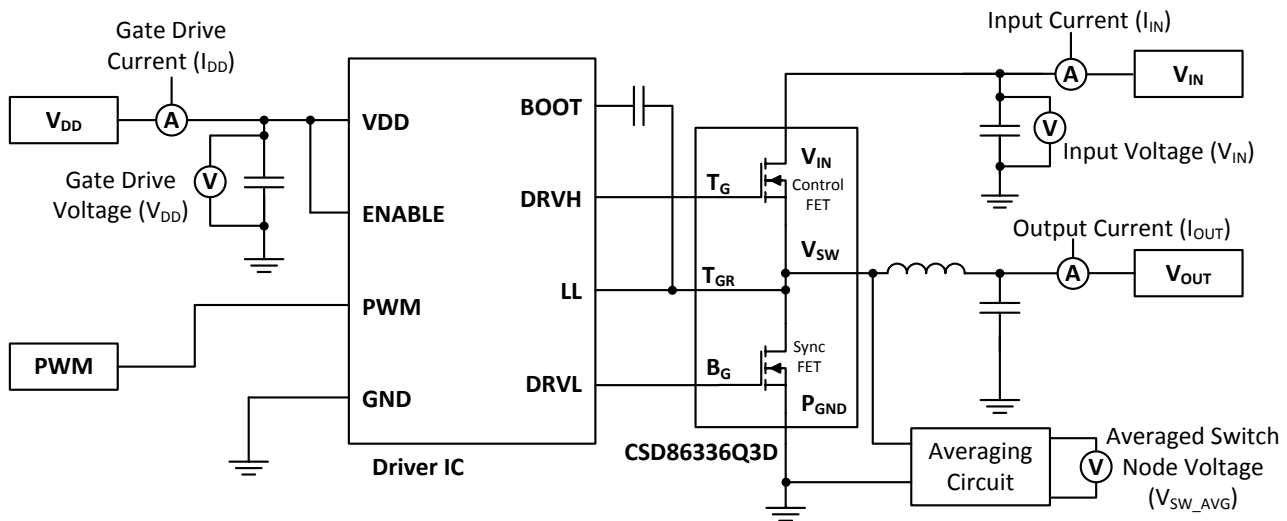
**Normalized Curves (continued)**

Copyright © 2017, Texas Instruments Incorporated

**Figure 30. Typical Application**
**6.5 Calculating Power Loss and Safe Operating Area (SOA)**

The user can estimate power loss and SOA boundaries by arithmetic means (see [Design Example](#)). Though the power loss and SOA curves in this data sheet are taken for a specific set of test conditions, the following procedure will outline the steps the user should take to predict product performance for any set of system conditions.

**6.5.1 Design Example**

Operating conditions:

- Output current = 18.0 A
- Input voltage = 5.0 V
- Output voltage = 1.8 V
- Switching frequency = 750 kHz
- Inductor = 290 nH

**6.5.2 Calculating Power Loss**

- Power loss at 18 A = 3.03 W ([Figure 1](#))
- Normalized power loss for input voltage  $\approx 1.1$  ([Figure 5](#))
- Normalized power loss for output voltage  $\approx 1.07$  ([Figure 6](#))
- Normalized power loss for switching frequency  $\approx 1.08$  ([Figure 4](#))
- Normalized power loss for output inductor  $\approx 1.0$  ([Figure 7](#))
- **Final calculated power loss =  $3.03 \text{ W} \times 1.1 \times 1.07 \times 1.08 \times 1.0 \approx 3.85 \text{ W}$**

**6.5.3 Calculating SOA Adjustments**

- SOA adjustment for input voltage  $\approx 1.0^\circ\text{C}$  ([Figure 5](#))
- SOA adjustment for output voltage  $\approx 0.68^\circ\text{C}$  ([Figure 6](#))
- SOA adjustment for switching frequency  $\approx 0.75^\circ\text{C}$  ([Figure 4](#))
- SOA adjustment for output inductor  $\approx 0.02^\circ\text{C}$  ([Figure 7](#))
- **Final calculated SOA adjustment =  $1.0 + 0.68 + 0.75 + 0.02 \approx 2.45^\circ\text{C}$**

**Calculating Power Loss and Safe Operating Area (SOA) (continued)**

In the design example above, the estimated power loss of the CSD86336Q3D would increase to 3.85 W. In addition, the maximum allowable board and/or ambient temperature would have to decrease by 2.45°C. Figure 31 graphically shows how the SOA curve would be adjusted accordingly.

1. Start by drawing a horizontal line from the application current to the SOA curve.
2. Draw a vertical line from the SOA curve intercept down to the board/ambient temperature.
3. Adjust the SOA board/ambient temperature by subtracting the temperature adjustment value.

In the design example, the SOA temperature adjustment yields a reduction in allowable board/ambient temperature of 2.45°C. In the event the adjustment value is a negative number, subtracting the negative number would yield an increase in allowable board/ambient temperature.

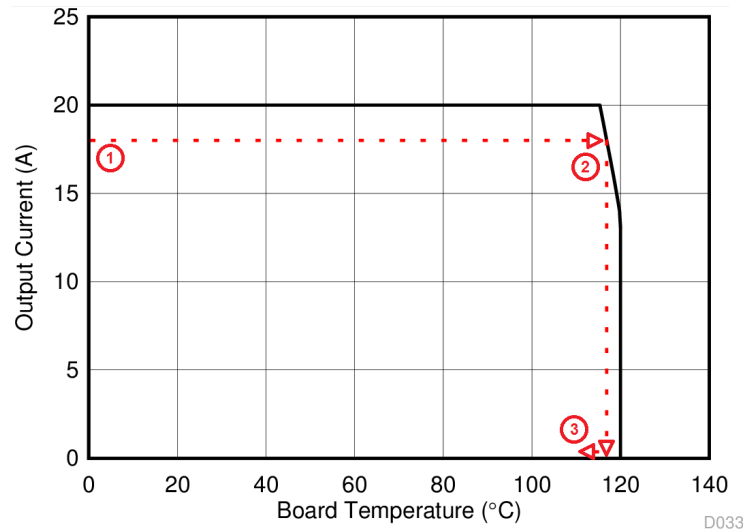

**Figure 31. Power Block SOA**

## 7 Layout

### 7.1 Recommended Schematic Overview

There are several critical components that must be used in conjunction with this power block device. Figure 32 shows a portion of a schematic with the critical components needed for proper operation.

- C22: Bypass capacitor for  $V_{IN}$  to help with ringing reduction
- C20: Bootstrap capacitor
- C21: Bypass capacitor for  $V_{DD}$
- C7-C14: Bypass capacitors for  $V_{IN}$  (minimum of 40  $\mu\text{F}$ )
- C15: Electrolytic capacitor for  $V_{IN}$
- R14, R16: Place holder for gate resistor (optional)
- R15: Place holder for bootstrap resistor (optional)
- R17, C16: Place holder for snubber (optional)

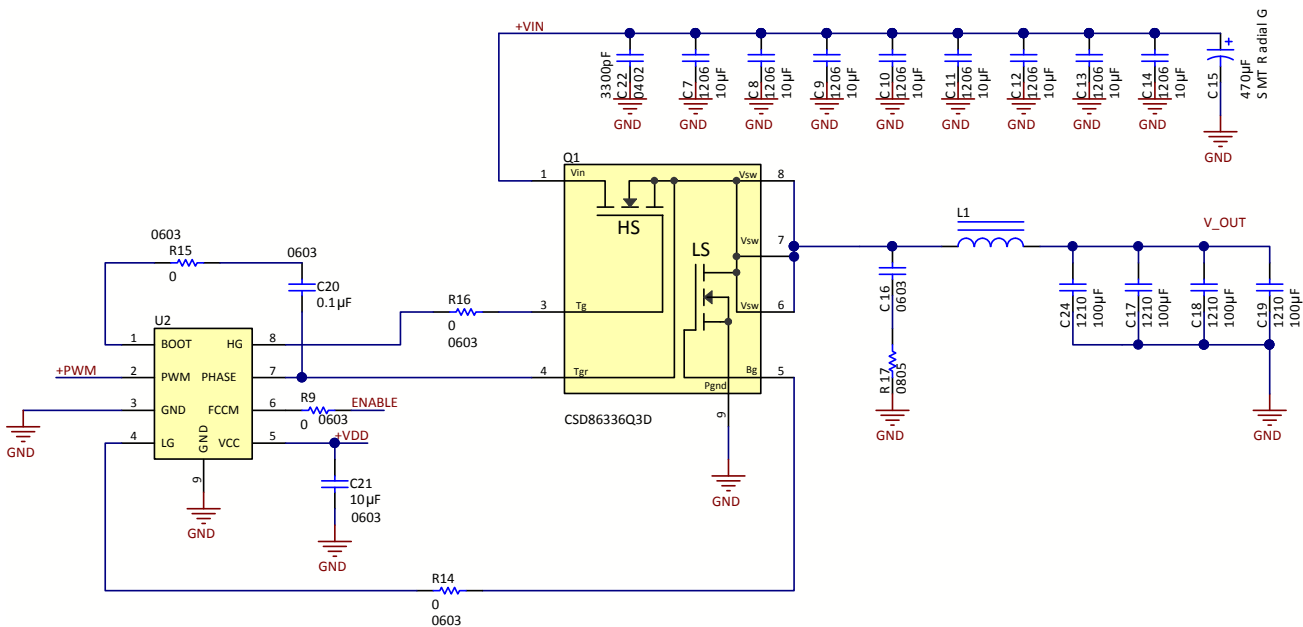

Copyright © 2017, Texas Instruments Incorporated

Figure 32. Recommended Schematic



## 7.2 Recommended PCB Design Overview

There are two key system-level parameters that can be addressed with a proper PCB design: electrical and thermal performance. Properly optimizing the PCB layout yields maximum performance in both areas. A brief description on how to address each parameter follows.

### 7.2.1 Electrical Performance

The power block has the ability to switch at voltage rates greater than 10 kV/ $\mu$ s. Special care must be taken with the PCB layout design and placement of the input capacitors, inductor, driver IC and output capacitors.

- The placement of the input capacitors relative to the power block's VIN and PGND pins should have the highest priority during the component placement routine. It is critical to minimize these node lengths. As such, ceramic input capacitors need to be placed as close as possible to the VIN and PGND pins (see [Figure 33](#)). It is recommended that one 3.3-nF (or similar), 0402, 50-V ceramic capacitor be placed on the top side of the board as close as possible to VIN and PGND pins. In addition, a minimum of 40  $\mu$ F of bulk ceramic capacitance should be placed as close as possible to the power block in a design. For high-density design, some of these ceramic capacitors can be placed on the bottom layer of PCB with appropriate number of vias interconnecting both layers.
- The driver IC should be placed relatively close to the power block gate pins. T<sub>G</sub> and B<sub>G</sub> should connect to the outputs of the driver IC. The T<sub>GR</sub> pin serves as the return path of the high-side gate drive circuitry and should be connected to the phase pin of the IC (sometimes called LX, LL, SW, PH, etc.). The bootstrap capacitor for the driver IC will also connect to this pin.
- The switching node of the output inductor should be placed relatively close to the power block VSW pins. Minimizing the node length between these two components will reduce the PCB conduction losses and actually reduce the switching noise level. In the event the switch node waveform exhibits ringing that reaches undesirable levels, the use of a boost resistor or RC snubber can be an effective way to easily reduce the peak ring level. The recommended boost resistor value will range between 1.0  $\Omega$  to 4.7  $\Omega$  depending on the output characteristics of driver IC used in conjunction with the power block. The RC snubber values can range from 0.5  $\Omega$  to 2.2  $\Omega$  for the R and 330 pF to 2200 pF for the C. Please refer to [Snubber Circuits: Theory, Design and Application](#) (SLUP100) for more details on how to properly tune the RC snubber values. The RC snubber should be placed as close as possible to the VSW node and PGND (see [Figure 33](#) and [Figure 34](#)).<sup>(1)</sup>

(1) Keong W. Kam, David Pommerenke, "EMI Analysis Methods for Synchronous Buck Converter EMI Root Cause Analysis", University of Missouri – Rolla

## Recommended PCB Design Overview (continued)

### 7.2.2 Thermal Performance

The power block has the ability to utilize the GND planes as the primary thermal path. As such, the use of thermal vias is an effective way to pull away heat from the device and into the system board. Concerns of solder voids and manufacturability problems can be addressed by the use of three basic tactics to minimize the amount of solder attach that will wick down the via barrel:

- Intentionally space out the vias from each other to avoid a cluster of holes in a given area.
- Use the smallest drill size allowed in your design. The examples in [Figure 33](#) and [Figure 34](#) use vias with a 10-mil drill hole and a 16-mil capture pad.
- Tent the opposite side of the via with solder-mask.

In the end, the number and drill size of the thermal vias should align with the end user's PCB design rules and manufacturing capabilities.

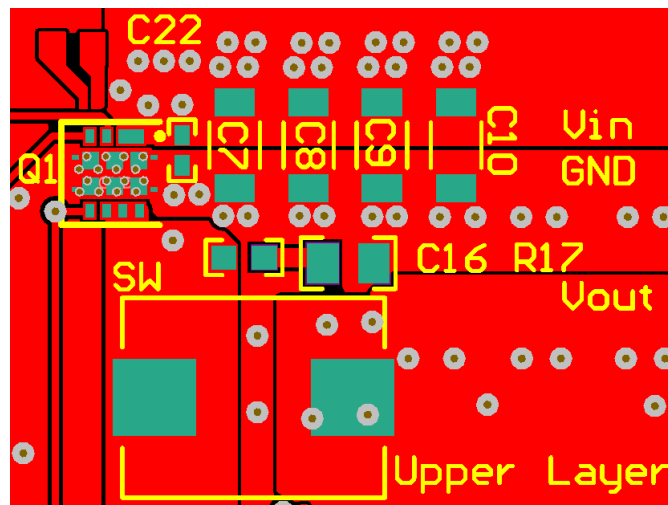

Figure 33. Recommended PCB Layout (Top Down View)

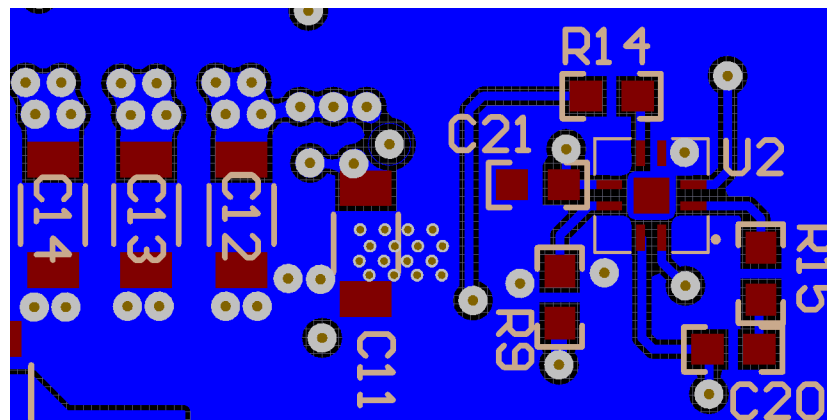

Figure 34. Recommended PCB Layout (Bottom View)

## 8 Device and Documentation Support

### 8.1 Receiving Notification of Documentation Updates

To receive notification of documentation updates, navigate to the device product folder on ti.com. In the upper right corner, click on *Alert me* to register and receive a weekly digest of any product information that has changed. For change details, review the revision history included in any revised document.

### 8.2 Community Resources

The following links connect to TI community resources. Linked contents are provided "AS IS" by the respective contributors. They do not constitute TI specifications and do not necessarily reflect TI's views; see TI's [Terms of Use](#).

**TI E2E™ Online Community** *TI's Engineer-to-Engineer (E2E) Community*. Created to foster collaboration among engineers. At e2e.ti.com, you can ask questions, share knowledge, explore ideas and help solve problems with fellow engineers.

**Design Support** *TI's Design Support* Quickly find helpful E2E forums along with design support tools and contact information for technical support.

### 8.3 Trademarks

NexFET, E2E are trademarks of Texas Instruments.  
All other trademarks are the property of their respective owners.

### 8.4 Electrostatic Discharge Caution



These devices have limited built-in ESD protection. The leads should be shorted together or the device placed in conductive foam during storage or handling to prevent electrostatic damage to the MOS gates.

### 8.5 Glossary

[SLYZ022](#) — *TI Glossary*.

This glossary lists and explains terms, acronyms, and definitions.

## 9 Mechanical, Packaging, and Orderable Information

The following pages include mechanical, packaging, and orderable information. This information is the most current data available for the designated devices. This data is subject to change without notice and revision of this document. For browser-based versions of this data sheet, refer to the left-hand navigation.

### 9.1 Q3D Package Dimensions

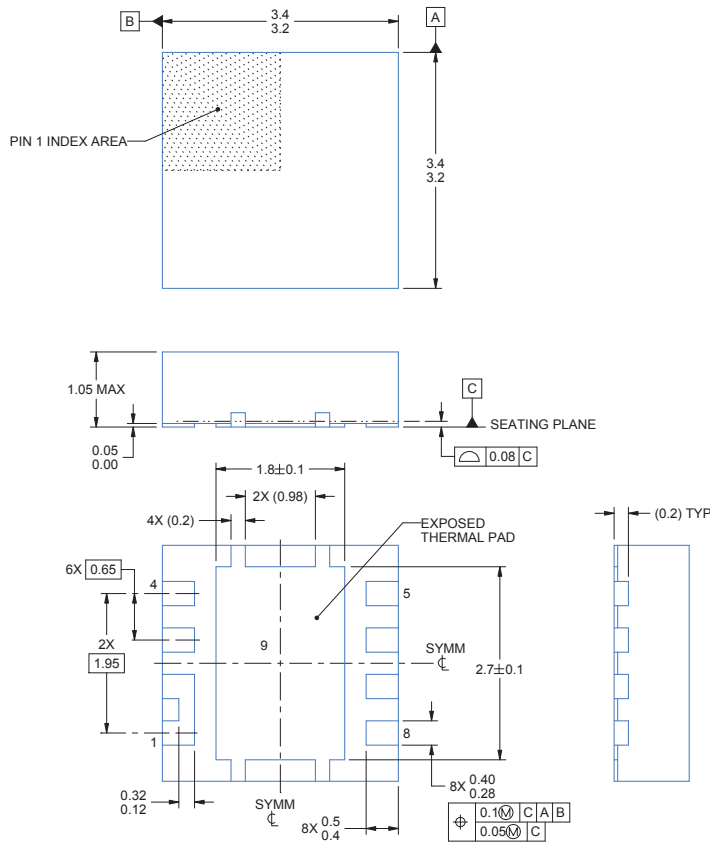

4218873/A 10/2016

1. All linear dimensions are in millimeters. Any dimensions in parenthesis are for reference only. Dimensioning and tolerancing per ASME Y14.5M.
2. This drawing is subject to change without notice.
3. The package thermal pad must be soldered to the printed circuit board for optimal thermal and mechanical performance.

### 9.2 Pin Configuration

POSITION	DESIGNATION
Pin 1	V <sub>IN</sub>
Pin 2	V <sub>IN</sub>
Pin 3	T <sub>G</sub>
Pin 4	T <sub>GR</sub>
Pin 5	B <sub>G</sub>
Pin 6	V <sub>SW</sub>
Pin 7	V <sub>SW</sub>
Pin 8	V <sub>SW</sub>
Pin 9	P <sub>GND</sub>

### 9.3 Land Pattern Recommendation

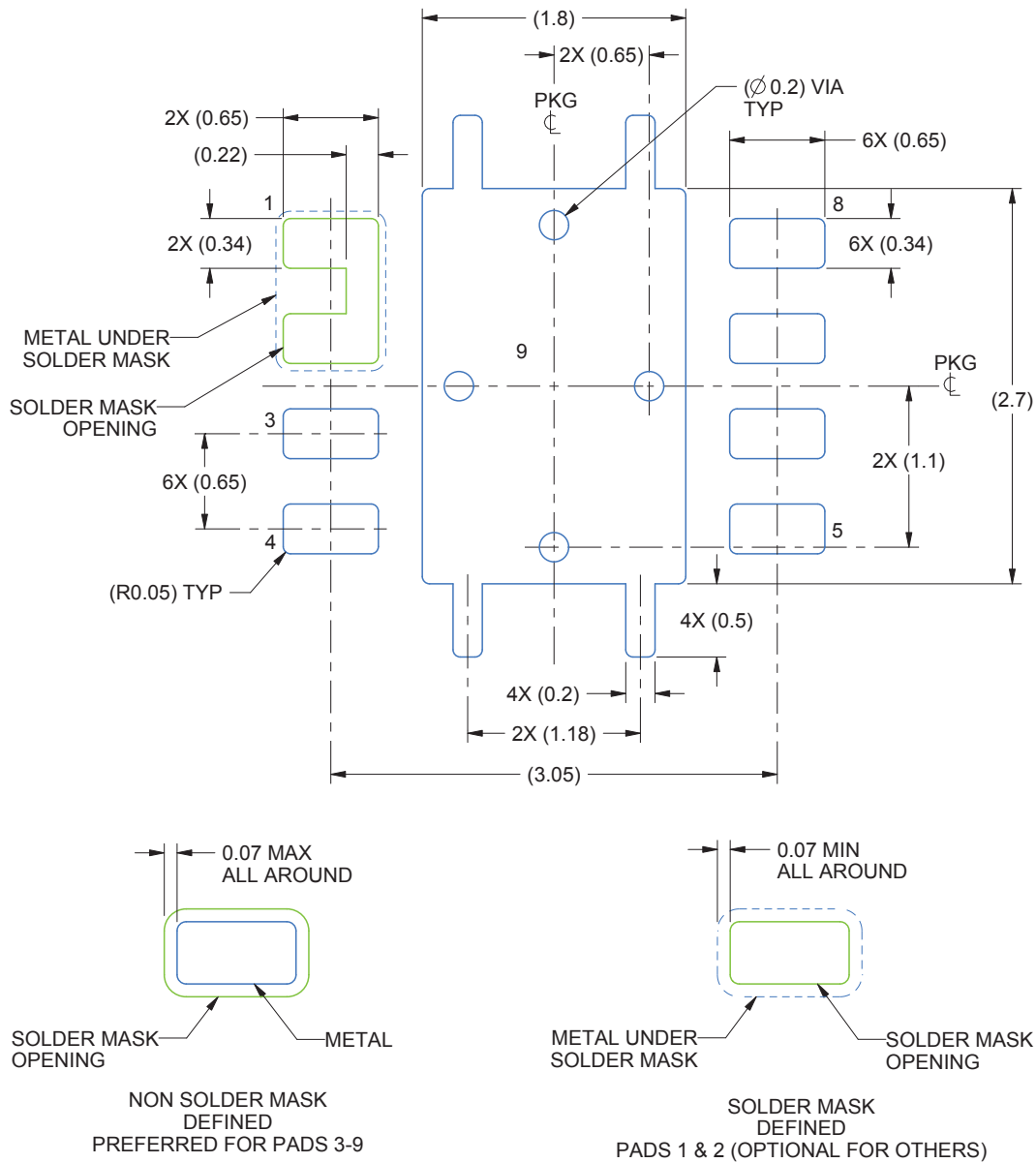

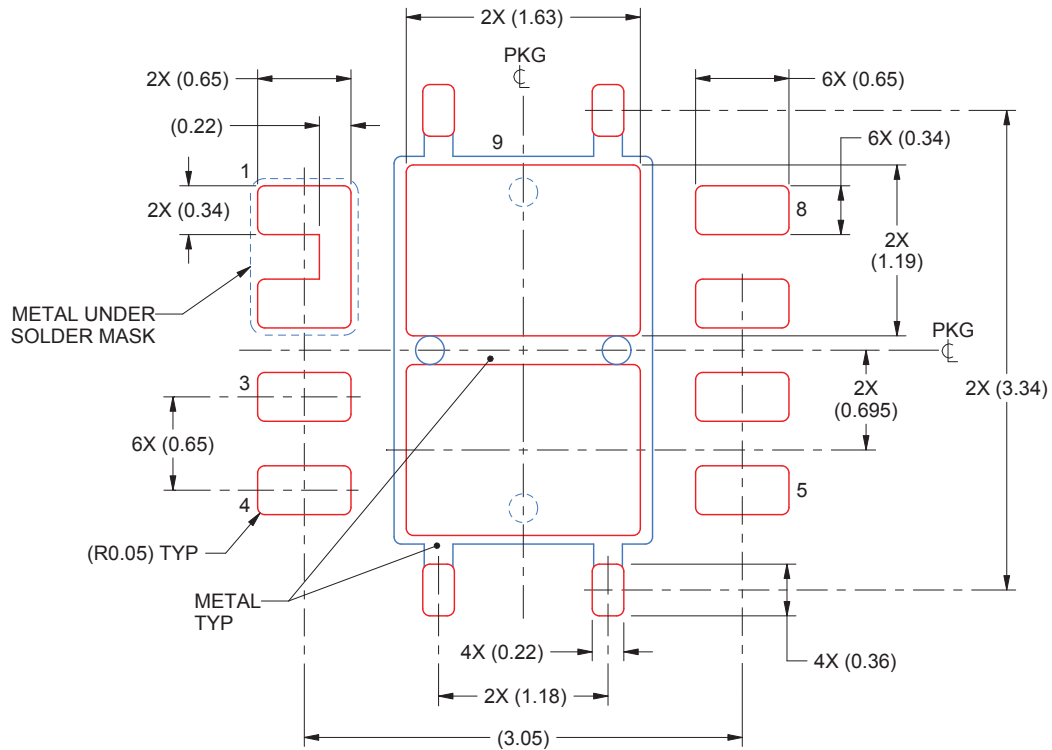

1. All linear dimensions are in millimeters. Any dimensions in parenthesis are for reference only. Dimensioning and tolerancing per ASME Y14.5M.
2. This package is designed to be soldered to a thermal pad on the board. For more information, see [QFN/SOP PCB Attachment](#) (SLUA271).
3. Vias are optional depending on application, refer to device data sheet. If some or all are implemented, recommended via locations are shown.

### 9.4 Stencil Recommendation



1. All linear dimensions are in millimeters. Any dimensions in parenthesis are for reference only. Dimensioning and tolerancing per ASME Y14.5M.
2. Laser cutting apertures with trapezoidal walls and rounded corners may offer better paste release. IPC-7525 may have alternate design recommendations.

## PACKAGING INFORMATION

Orderable Device	Status (1)	Package Type	Package Drawing	Pins	Package Qty	Eco Plan (2)	Lead finish/ Ball material (6)	MSL Peak Temp (3)	Op Temp (°C)	Device Marking (4/5)	Samples
CSD86336Q3D	ACTIVE	VSON-CLIP	DPB	8	2500	RoHS-Exempt & Green	SN	Level-1-260C-UNLIM	-55 to 150	86336D	
CSD86336Q3DT	ACTIVE	VSON-CLIP	DPB	8	250	RoHS-Exempt & Green	SN	Level-1-260C-UNLIM	-55 to 150	86336D	

(1) The marketing status values are defined as follows:

**ACTIVE:** Product device recommended for new designs.

**LIFEBUY:** TI has announced that the device will be discontinued, and a lifetime-buy period is in effect.

**NRND:** Not recommended for new designs. Device is in production to support existing customers, but TI does not recommend using this part in a new design.

**PREVIEW:** Device has been announced but is not in production. Samples may or may not be available.

**OBSOLETE:** TI has discontinued the production of the device.

(2) **RoHS:** TI defines "RoHS" to mean semiconductor products that are compliant with the current EU RoHS requirements for all 10 RoHS substances, including the requirement that RoHS substance do not exceed 0.1% by weight in homogeneous materials. Where designed to be soldered at high temperatures, "RoHS" products are suitable for use in specified lead-free processes. TI may reference these types of products as "Pb-Free".

**RoHS Exempt:** TI defines "RoHS Exempt" to mean products that contain lead but are compliant with EU RoHS pursuant to a specific EU RoHS exemption.

**Green:** TI defines "Green" to mean the content of Chlorine (Cl) and Bromine (Br) based flame retardants meet JS709B low halogen requirements of <=1000ppm threshold. Antimony trioxide based flame retardants must also meet the <=1000ppm threshold requirement.

(3) MSL, Peak Temp. - The Moisture Sensitivity Level rating according to the JEDEC industry standard classifications, and peak solder temperature.

(4) There may be additional marking, which relates to the logo, the lot trace code information, or the environmental category on the device.

(5) Multiple Device Markings will be inside parentheses. Only one Device Marking contained in parentheses and separated by a "~" will appear on a device. If a line is indented then it is a continuation of the previous line and the two combined represent the entire Device Marking for that device.

(6) Lead finish/Ball material - Orderable Devices may have multiple material finish options. Finish options are separated by a vertical ruled line. Lead finish/Ball material values may wrap to two lines if the finish value exceeds the maximum column width.

**Important Information and Disclaimer:** The information provided on this page represents TI's knowledge and belief as of the date that it is provided. TI bases its knowledge and belief on information provided by third parties, and makes no representation or warranty as to the accuracy of such information. Efforts are underway to better integrate information from third parties. TI has taken and continues to take reasonable steps to provide representative and accurate information but may not have conducted destructive testing or chemical analysis on incoming materials and chemicals. TI and TI suppliers consider certain information to be proprietary, and thus CAS numbers and other limited information may not be available for release.

In no event shall TI's liability arising out of such information exceed the total purchase price of the TI part(s) at issue in this document sold by TI to Customer on an annual basis.





**TAPE AND REEL INFORMATION**

**QUADRANT ASSIGNMENTS FOR PIN 1 ORIENTATION IN TAPE**

\*All dimensions are nominal

Device	Package Type	Package Drawing	Pins	SPQ	Reel Diameter (mm)	Reel Width W1 (mm)	A0 (mm)	B0 (mm)	K0 (mm)	P1 (mm)	W (mm)	Pin1 Quadrant
CSD86336Q3D	VSON-CLIP	DPB	8	2500	330.0	12.4	3.6	3.6	1.2	8.0	12.0	Q1
CSD86336Q3DT	VSON-CLIP	DPB	8	250	330.0	12.4	3.6	3.6	1.2	8.0	12.0	Q1

**TAPE AND REEL BOX DIMENSIONS**

\*All dimensions are nominal

Device	Package Type	Package Drawing	Pins	SPQ	Length (mm)	Width (mm)	Height (mm)
CSD86336Q3D	VSON-CLIP	DPB	8	2500	336.6	336.6	41.3
CSD86336Q3DT	VSON-CLIP	DPB	8	250	336.6	336.6	41.3

## IMPORTANT NOTICE AND DISCLAIMER

TI PROVIDES TECHNICAL AND RELIABILITY DATA (INCLUDING DATA SHEETS), DESIGN RESOURCES (INCLUDING REFERENCE DESIGNS), APPLICATION OR OTHER DESIGN ADVICE, WEB TOOLS, SAFETY INFORMATION, AND OTHER RESOURCES "AS IS" AND WITH ALL FAULTS, AND DISCLAIMS ALL WARRANTIES, EXPRESS AND IMPLIED, INCLUDING WITHOUT LIMITATION ANY IMPLIED WARRANTIES OF MERCHANTABILITY, FITNESS FOR A PARTICULAR PURPOSE OR NON-INFRINGEMENT OF THIRD PARTY INTELLECTUAL PROPERTY RIGHTS.

These resources are intended for skilled developers designing with TI products. You are solely responsible for (1) selecting the appropriate TI products for your application, (2) designing, validating and testing your application, and (3) ensuring your application meets applicable standards, and any other safety, security, regulatory or other requirements.

These resources are subject to change without notice. TI grants you permission to use these resources only for development of an application that uses the TI products described in the resource. Other reproduction and display of these resources is prohibited. No license is granted to any other TI intellectual property right or to any third party intellectual property right. TI disclaims responsibility for, and you will fully indemnify TI and its representatives against, any claims, damages, costs, losses, and liabilities arising out of your use of these resources.

TI's products are provided subject to [TI's Terms of Sale](#) or other applicable terms available either on [ti.com](http://ti.com) or provided in conjunction with such TI products. TI's provision of these resources does not expand or otherwise alter TI's applicable warranties or warranty disclaimers for TI products.

TI objects to and rejects any additional or different terms you may have proposed.

Mailing Address: Texas Instruments, Post Office Box 655303, Dallas, Texas 75265  
Copyright © 2022, Texas Instruments Incorporated