

# SN54122, SN54123, SN54130, SN54LS122, SN54LS123, SN74122, SN74123, SN74130, SN74LS122, SN74LS123 RETRIGGERABLE MONOSTABLE MULTIVIBRATORS

SDLS043 - DECEMBER 1983 - REVISED MARCH 1988

- D-C Triggered from Active-High or Active-Low Gated Logic Inputs
- Retriggerable for Very Long Output Pulses, Up to 100% Duty Cycle
- Overriding Clear Terminates Output Pulse
- '122 and 'LS122 Have Internal Timing Resistors

## description

These d-c triggered multivibrators feature output pulse-duration control by three methods. The basic pulse time is programmed by selection of external resistance and capacitance values (see typical application data). The '122 and 'LS122 have internal timing resistors that allow the circuits to be used with only an external capacitor, if so desired. Once triggered, the basic pulse duration may be extended by retriggering the gated low-level-active (A) or high-level-active (B) inputs, or be reduced by use of the overriding clear. Figure 1 illustrates pulse control by retriggering and early clear.

The 'LS122 and 'LS123 are provided enough Schmitt hysteresis to ensure jitter-free triggering from the B input with transition rates as slow as 0.1 millivolt per nanosecond.

The  $R_{int}$  is nominal 10 k $\Omega$  for '122 and 'LS122.

SN54123, SN54130, SN54LS123 . . . J OR W PACKAGE  
SN74123, SN74130 . . . N PACKAGE  
SN74LS123 . . . D OR N PACKAGE  
(TOP VIEW) (SEE NOTES 1 THRU 4)



SN54LS122 . . . FK PACKAGE  
(TOP VIEW) (SEE NOTES 1 THRU 4)



SN54122, SN54LS122 . . . J OR W PACKAGE  
SN74122 . . . N PACKAGE  
SN74LS122 . . . D OR N PACKAGE  
(TOP VIEW) (SEE NOTES 1 THRU 4)

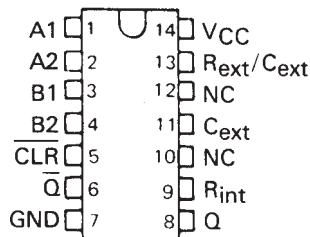

- NOTES: 1. An external timing capacitor may be connected between  $C_{ext}$  and  $R_{ext}/C_{ext}$  (positive).
2. To use the internal timing resistor of '122 or 'LS122, connect  $R_{int}$  to  $V_{CC}$ .
3. For improved pulse duration accuracy and repeatability, connect an external resistor between  $R_{ext}/C_{ext}$  and  $V_{CC}$  with  $R_{int}$  open-circuited.
4. To obtain variable pulse durations, connect an external variable resistance between  $R_{int}$  or  $R_{ext}/C_{ext}$  and  $V_{CC}$ .

SN54LS123 . . . FK PACKAGE  
(TOP VIEW) (SEE NOTES 1 THRU 4)



NC - No internal connection

PRODUCTION DATA information is current as of publication date. Products conform to specifications per the terms of Texas Instruments standard warranty. Production processing does not necessarily include testing of all parameters.

 **TEXAS  
INSTRUMENTS**

POST OFFICE BOX 655303 • DALLAS, TEXAS 75265

**SN54122, SN54123, SN54130, SN54LS122, SN54LS123,  
SN74122, SN74123, SN74130, SN74LS122, SN74LS123  
RETRIGGERABLE MONOSTABLE MULTIVIBRATORS**

SDLS043 – DECEMBER 1983 – REVISED MARCH 1988

description (continued)

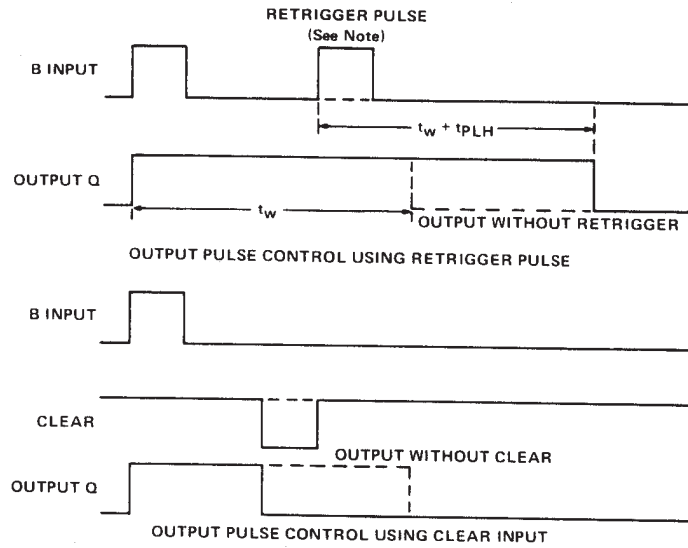

NOTE: Retrigger pulses starting before  $0.22 C_{ext}$  (in picoseconds) nanoseconds after the initial trigger pulse will be ignored and the output duration will remain unchanged.

FIGURE 1—TYPICAL INPUT/OUTPUT PULSES

'122, 'LS122  
FUNCTION TABLE

INPUTS					OUTPUTS	
CLEAR	A1	A2	B1	B2	Q	$\bar{Q}$
L	X	X	X	X	L	H
X	H	H	X	X	L <sup>†</sup>	H <sup>†</sup>
X	X	X	L	X	L <sup>†</sup>	H <sup>†</sup>
X	X	X	X	L	L <sup>†</sup>	H <sup>†</sup>
H	L	X	↑	H	$\square$	$\sqcup$
H	L	X	H	↑	$\square$	$\sqcup$
H	X	L	↑	H	$\square$	$\sqcup$
H	X	L	H	↑	$\square$	$\sqcup$
H	H	↓	H	H	$\square$	$\sqcup$
H	↓	↓	H	H	$\square$	$\sqcup$
H	↓	H	H	H	$\square$	$\sqcup$
↑	L	X	H	H	$\square$	$\sqcup$
↑	X	L	H	H	$\square$	$\sqcup$

'123, '130, 'LS123  
FUNCTION TABLE

INPUTS			OUTPUTS	
CLEAR	A	B	Q	$\bar{Q}$
L	X	X	L	H
X	H	X	L <sup>†</sup>	H <sup>†</sup>
X	X	L	L <sup>†</sup>	H <sup>†</sup>
H	L	↑	$\square$	$\sqcup$
H	↓	H	$\square$	$\sqcup$
↑	L	H	$\square$	$\sqcup$

See explanation of function tables on page

† These lines of the functional tables assume that the indicated steady-state conditions at the A and B inputs have been set up long enough to complete any pulse started before the set up.



POST OFFICE BOX 655303 • DALLAS, TEXAS 75265

SN54122, SN54123, SN54130, SN54LS122, SN54LS123,  
 SN74122, SN74123, SN74130, SN74LS122, SN74LS123  
 RETRIGGERABLE MONOSTABLE MULTIVIBRATORS

SDLS043 – DECEMBER 1983 – REVISED MARCH 1988

logic diagram (positive logic)

logic symbol†



$R_{int}$  is nominally 10 k $\Omega$  for '122 and 'LS122

logic diagram (positive logic) (each multivibrator)

logic symbol†



Pin numbers shown are for D, J, N, and W packages.

†These symbols are in accordance with ANSI/IEEE Std 91-1984 and IEC Publication 617-12.

SN54122, SN54123, SN54130, SN54LS122, SN54LS123,  
 SN74122, SN74123, SN74130, SN74LS122, SN74LS123  
**RETRIGGERABLE MONOSTABLE MULTIVIBRATORS**

SDLS043 – DECEMBER 1983 – REVISED MARCH 1988

schematics of inputs and outputs

'122, '123, '130 CIRCUITS

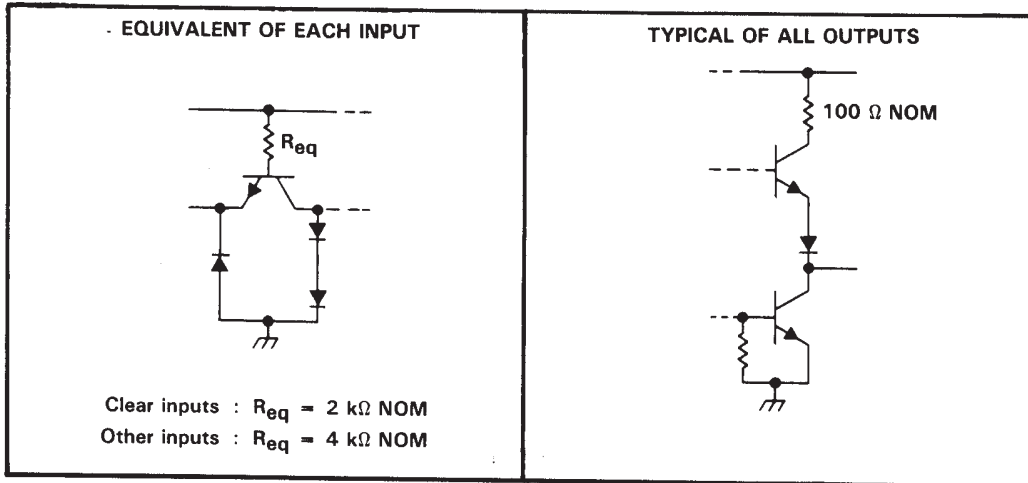

'LS122, 'LS123 CIRCUITS

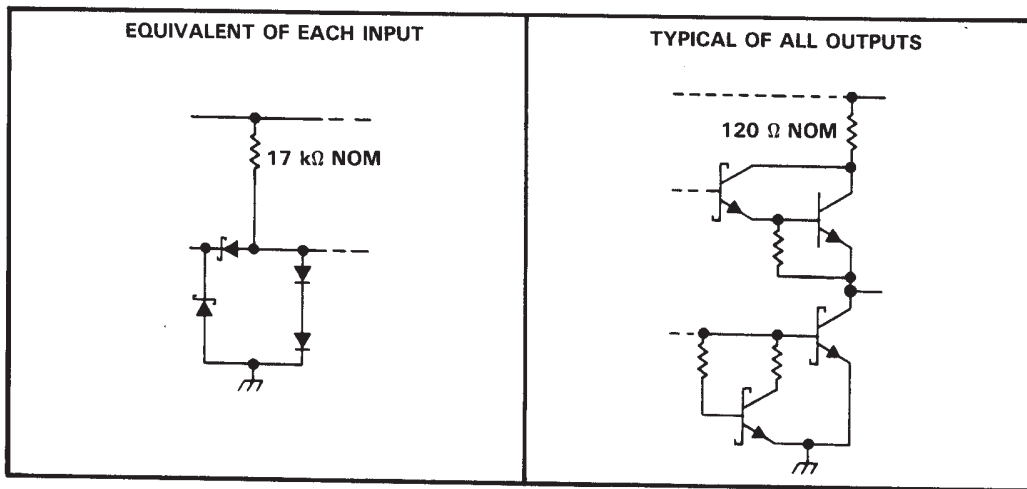

**absolute maximum ratings over operating free-air temperature range (unless otherwise noted)**

Supply voltage, $V_{CC}$ (see Note 1)	7 V
Input voltage: '122, '123, '130	5.5 V
'LS122, 'LS123	7 V
Operating free-air temperature range: SN54'	$-55^{\circ}\text{C}$ to $125^{\circ}\text{C}$
SN74'	$0^{\circ}\text{C}$ to $70^{\circ}\text{C}$
Storage temperature range	$-65^{\circ}\text{C}$ to $150^{\circ}\text{C}$

NOTE 1: Voltage values are with respect to network ground terminal.



POST OFFICE BOX 655303 • DALLAS, TEXAS 75265

# SN54122, SN54123, SN54130, SN74122, SN74123, SN74130 RETRIGGERABLE MONOSTABLE MULTIVIBRATORS

SDLS043 – DECEMBER 1983 – REVISED MARCH 1988

## recommended operating conditions

	SN54'			SN74'			UNIT
	MIN	NOM	MAX	MIN	NOM	MAX	
Supply voltage, $V_{CC}$	4.5	5	5.5	4.75	5	5.25	V
High-level output current, $I_{OH}$	-800			-800			$\mu A$
Low-level output current, $I_{OL}$	16			16			mA
Pulse duration, $t_w$	40			40			ns
External timing resistance, $R_{ext}$	5			25			$k\Omega$
External capacitance, $C_{ext}$	No restriction			No restriction			
Wiring capacitance at $R_{ext}/C_{ext}$ terminal	50			50			pF
Operating free-air temperature, $T_A$	-55			125			$^{\circ}C$

## electrical characteristics over recommended free-air operating temperature range (unless otherwise noted)

PARAMETER	TEST CONDITIONS†	'122			'123, '130			UNIT
		MIN	TYP‡	MAX	MIN	TYP‡	MAX	
$V_{IH}$ High-level input voltage		2			2			V
$V_{IL}$ Low-level input voltage		0.8			0.8			V
$V_{IK}$ Input clamp voltage	$V_{CC} = \text{MIN}, I_I = -12 \text{ mA}$	-1.5			-1.5			V
$V_{OH}$ High-level output voltage	$V_{CC} = \text{MIN}, I_{OH} = -800 \mu A$ , See Note 5	2.4	3.4		2.4	3.4		V
$V_{OL}$ Low-level output voltage	$V_{CC} = \text{MIN}, I_{OL} = 16 \text{ mA}$ , See Note 5	0.2	0.4		0.2	0.4		V
$I_I$ Input current at maximum input voltage	$V_{CC} = \text{MAX}, V_I = 5.5 \text{ V}$	1			1			mA
$I_{IH}$ High-level input current	Data inputs	40			40			$\mu A$
	Clear input	80			80			
$I_{IL}$ Low-level input current	Data inputs	-1.6			-1.6			mA
	Clear input	-3.2			-3.2			
$I_{OS}$ Short-circuit output current‡	$V_{CC} = \text{MAX}$ , See Note 5	-10			-10			mA
$I_{CC}$ Supply current (quiescent or triggered)	$V_{CC} = \text{MAX}$ , See Notes 6 and 7	23	36		46	66		mA

† For conditions shown as MIN or MAX, use the appropriate value specified under recommended operating conditions.

‡ All typical values are at  $V_{CC} = 5 \text{ V}, T_A = 25^{\circ}C$ .

§ Not more than one output should be shorted at a time.

NOTES: 5. Ground  $C_{ext}$  to measure  $V_{OH}$  at Q,  $V_{OL}$  at  $\bar{Q}$ , or  $I_{OS}$  at Q.  $C_{ext}$  is open to measure  $V_{OH}$  at  $\bar{Q}$ ,  $V_{OL}$  at Q, or  $I_{OS}$  at  $\bar{Q}$ .

6. Quiescent  $I_{CC}$  is measured (after clearing) with 4.5 V applied to all clear and A inputs, B inputs grounded, all outputs open and  $R_{ext} = 25 \text{ k}\Omega$ .  $R_{int}$  of '122 is open.

7.  $I_{CC}$  is measured in the triggered state with 2.4 V applied to all clear and B inputs, A inputs grounded, all outputs open,  $C_{ext} = 0.02 \mu F$ , and  $R_{ext} = 25 \text{ k}\Omega$ .  $R_{int}$  of '122 is open.

## switching characteristics, $V_{CC} = 5 \text{ V}, T_A = 25^{\circ}C$ , see note 8

PARAMETER¶	FROM (INPUT)	TO (OUTPUT)	TEST CONDITIONS	'122, '130			'123			UNIT
				MIN	TYP	MAX	MIN	TYP	MAX	
$t_{PLH}$	A	Q	$C_{ext} = 0, R_{ext} = 5 \text{ k}\Omega,$ $C_L = 15 \text{ pF}, R_L = 400 \Omega$	22	33		22	33	ns	
	B			19	28		19	28		
$t_{PHL}$	A	$\bar{Q}$		30	40		30	40	ns	
	B			27	36		27	36		
$t_{PHL}$	Clear	Q		18	27		18	27	ns	
$t_{PLH}$		$\bar{Q}$		30	40		30	40		
$t_{wQ}(\text{min})$	A or B	Q		45	65		45	76	ns	
$t_{wQ}$	A or B	Q		3.08	3.42	3.76	2.76	3.03	3.37	$\mu s$

¶  $t_{PLH}$  = propagation delay time, low-to-high-level output

$t_{PHL}$  = propagation delay time, high-to-low-level output

$t_{wQ}$  = duration of pulse at output Q.

NOTE 8: Load circuits and voltage waveforms are shown in Section 1.



# SN54LS122, SN54LS123, SN74LS122, SN74LS123 RETRIGGERABLE MONOSTABLE MULTIVIBRATORS

SDLS043 – DECEMBER 1983 – REVISED MARCH 1988

## recommended operating conditions

	SN54LS'			SN74LS'			UNIT
	MIN	NOM	MAX	MIN	NOM	MAX	
Supply voltage, $V_{CC}$	4.5	5	5.5	4.75	5	5.25	V
High-level output current, $I_{OH}$			-400			-400	$\mu$ A
Low-level output current, $I_{OL}$			4			8	mA
Pulse duration, $t_w$	40			40			ns
External timing resistance, $R_{ext}$	5		180	5		260	k $\Omega$
External capacitance, $C_{ext}$	No restriction			No restriction			
Wiring capacitance at $R_{ext}/C_{ext}$ terminal			50			50	pF
Operating free-air temperature, $T_A$	-55		125	0		70	$^{\circ}$ C

## electrical characteristics over recommended operating free-air temperature range (unless otherwise noted)

PARAMETER	TEST CONDITIONS†	SN54LS'			SN74LS'			UNIT
		MIN	TYP‡	MAX	MIN	TYP‡	MAX	
$V_{IH}$ High-level input voltage		2			2			V
$V_{IL}$ Low-level input voltage				0.7			0.8	V
$V_{IK}$ Input clamp voltage	$V_{CC} = \text{MIN}, I_I = -18 \text{ mA}$			-1.5			-1.5	V
$V_{OH}$ High-level output voltage	$V_{CC} = \text{MIN}, V_{IL} = V_{IL \text{ max}}, I_{OH} = -400 \mu\text{A}$	2.5	3.5		2.7	3.5		V
$V_{OL}$ Low-level output voltage	$V_{CC} = \text{MIN}, V_{IH} = 2 \text{ V}, V_{IL} = V_{IL \text{ max}}$			0.25	0.4	0.25	0.4	V
						0.35	0.5	
$I_I$ Input current at maximum input voltage	$V_{CC} = \text{MAX}, V_I = 7 \text{ V}$			0.1			0.1	mA
$I_{IH}$ High-level input current	$V_{CC} = \text{MAX}, V_I = 2.7 \text{ V}$			20			20	$\mu$ A
$I_{IL}$ Low-level input current	$V_{CC} = \text{MAX}, V_I = 0.4 \text{ V}$			-0.4			-0.4	mA
$I_{OS}$ Short-circuit output current§	$V_{CC} = \text{MAX}$	-20		-100	-20		-100	mA
$I_{CC}$ Supply current (quiescent or triggered)	$V_{CC} = \text{MAX},$ See Note 13			6	11	6	11	mA
				12	20	12	20	

†For conditions shown as MIN or MAX, use the appropriate value specified under recommended operating conditions.

‡All typical values are at  $V_{CC} = 5 \text{ V}, T_A = 25^{\circ}\text{C}$ .

§Not more than one output should be shorted at a time and duration of the short-circuit should not exceed one second.

NOTES: 12. To measure  $V_{OH}$  at Q,  $V_{OL}$  at Q, or  $I_{OS}$  at Q, ground  $R_{ext}/C_{ext}$ , apply 2 V to B and clear, and pulse A from 2 V to 0 V.  
13. With all outputs open and 4.5 V applied to all data and clear inputs.  $I_{CC}$  is measured after a momentary ground, then 4.5 V, is applied to A or B inputs.

## switching characteristics, $V_{CC} = 5 \text{ V}, T_A = 25^{\circ}\text{C}$ (see note 8)

PARAMETER¶	FROM (INPUT)	TO (OUTPUT)	TEST CONDITIONS	MIN	TYP	MAX	UNIT
$t_{PLH}$	A	Q	$C_{ext} = 0, R_{ext} = 5 \text{ k}\Omega, C_L = 15 \text{ pF}, R_L = 2 \text{ k}\Omega$	23	33	ns	
	B			23	44		
$t_{PHL}$	A	$\bar{Q}$		32	45	ns	
	B	$\bar{Q}$		34	56		
$t_{PHL}$	Clear	Q		20	27	ns	
$t_{PLH}$		$\bar{Q}$		28	45		
$t_{wQ}(\text{min})$	A or B	Q			116	200	ns
$t_{wQ}$	A or B	Q		$C_{ext} = 1000 \text{ pF}, C_L = 15 \text{ pF}, R_{ext} = 10 \text{ k}\Omega, R_L = 2 \text{ k}\Omega$	4	4.5	5

¶ $t_{PLH}$  = propagation delay time, low-to-high-level output

$t_{PHL}$  = propagation delay time, high-to-low-level output

$t_{wQ}$  = duration of pulse at output Q.

NOTE 8: Load circuits and voltage waveforms are shown in Section 1.



# SN54122, SN54123, SN54130, SN74122, SN74123, SN74130 RETRIGGERABLE MONOSTABLE MULTIVIBRATORS

SDLS043 – DECEMBER 1983 – REVISED MARCH 1988

## TYPICAL APPLICATION DATA FOR '122, '123, '130

For pulse durations when  $C_{ext} \leq 1000$  pF, see Figure 4.

The output pulse duration is primarily a function of the external capacitor and resistor. For  $C_{ext} > 1000$  pF, the output pulse duration ( $t_w$ ) is defined as:

$$t_w = K \cdot R_T \cdot C_{ext} \left( 1 + \frac{0.7}{R_T} \right)$$

where

$K$  is 0.32 for '122, 0.28 for '123 and '130

$R_T$  is in  $k\Omega$  (internal or external timing resistance.)

$C_{ext}$  is in pF

$t_w$  is in ns

To prevent reverse voltage across  $C_{ext}$ , it is recommended that the method shown in Figure 2 be employed when using electrolytic capacitors and in applications utilizing the clear function. In all applications using the diode, the pulse duration is:

$$t_w = K_D \cdot R_T \cdot C_{ext} \left( 1 + \frac{0.7}{R_T} \right)$$

$K_D$  is 0.28 for '122, 0.25 for '123 and '130

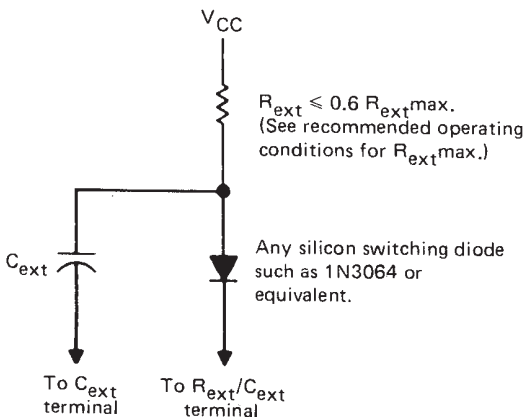

TIMING COMPONENT CONNECTIONS WHEN  $C_{ext} > 1000$  pF AND CLEAR IS USED

FIGURE 2

Applications requiring more precise pulse durations (up to 28 seconds) and not requiring the clear feature can best be satisfied with the '121.



TIMING COMPONENT CONNECTIONS  
FIGURE 3

## TYPICAL OUTPUT PULSE DURATION vs EXTERNAL TIMING CAPACITANCE

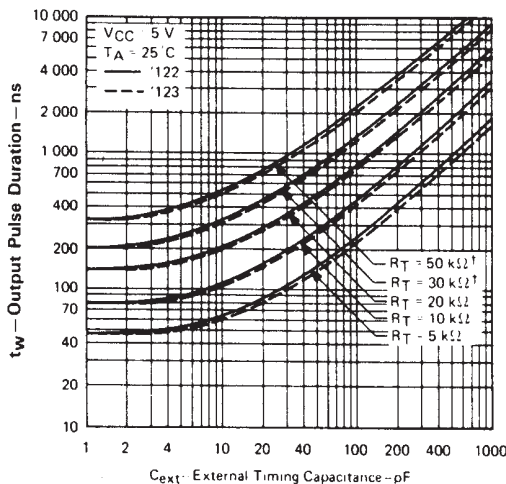

FIGURE 4

†These values of resistance exceed the maximum recommended for use over the full temperature range of the SN54' circuits.

# SN54LS122, SN54LS123, SN74LS122, SN74LS123 RETRIGGERABLE MONOSTABLE MULTIVIBRATORS

SDLS043 – DECEMBER 1983 – REVISED MARCH 1988

## TYPICAL APPLICATION DATA FOR 'LS122, 'LS123

The basic output pulse duration is essentially determined by the values of external capacitance and timing resistance. For pulse durations when  $C_{ext} \leq 1000$  pF, use Figure 6, or use Figure 7 where the pulse duration may be defined as:

$$t_w = K \cdot R_T \cdot C_{ext}$$

When  $C_{ext} \geq 1 \mu F$ , the output pulse width is defined as:

$$t_w = 0.33 \cdot R_T \cdot C_{ext}$$

For the above two equations, as applicable;

- K is multiplier factor, see Figure 7
- $R_T$  is in  $k\Omega$  (internal or external timing resistance)
- $C_{ext}$  is in pF
- $t_w$  is in ns

For maximum noise immunity, system ground should be applied to the  $C_{ext}$  node, even though the  $C_{ext}$  node is already tied to the ground lead internally. Due to the timing scheme used by the 'LS122 and 'LS123, a switching diode is not required to prevent reverse biasing when using electrolytic capacitors.

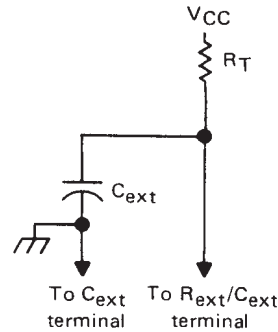

TIMING COMPONENT CONNECTIONS  
FIGURE 5

## 'LS122, 'LS123 TYPICAL OUTPUT PULSE DURATION vs EXTERNAL TIMING CAPACITANCE

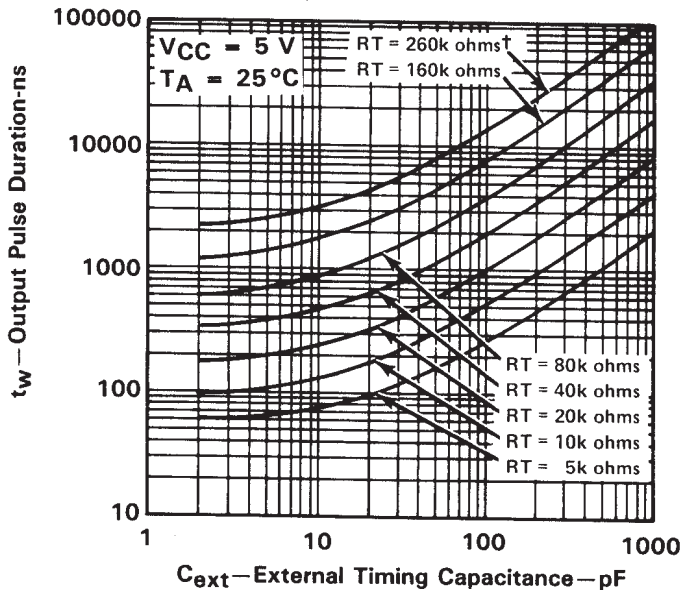

<sup>†</sup>This value of resistance exceeds the maximum recommended for use over the full temperature range of the SN54LS circuits.

FIGURE 6



# SN54LS122, SN54LS123, SN74LS122, SN74LS123 RETRIGGERABLE MONOSTABLE MULTIVIBRATORS

SDLS043 – DECEMBER 1983 – REVISED MARCH 1988

## TYPICAL APPLICATION DATA FOR 'LS122, 'LS123†



FIGURE 7



FIGURE 8



FIGURE 9



FIGURE 10

NOTE 14: For the 'LS122, the internal timing resistor,  $R_{int}$  was used. For the 'LS122/123, an external timing resistor was used for  $R_T$ .  
†Data for temperatures below  $0^\circ C$  and above  $70^\circ C$  and for supply voltages below 4.75 V and above 5.25 V are applicable for SN54LS122 and SN54LS123 only.

**PACKAGING INFORMATION**

Orderable Device	Status (1)	Package Type	Package Drawing	Pins	Package Qty	Eco Plan (2)	Lead finish/ Ball material (6)	MSL Peak Temp (3)	Op Temp (°C)	Device Marking (4/5)	Samples
5962-7603901VEA	ACTIVE	CDIP	J	16	1	Non-RoHS & Green	SNPB	N / A for Pkg Type	-55 to 125	5962-7603901VE A SNV54LS123J	<a href="#">Samples</a>
5962-7603901VFA	ACTIVE	CFP	W	16	1	Non-RoHS & Green	SNPB	N / A for Pkg Type	-55 to 125	5962-7603901VF A SNV54LS123W	<a href="#">Samples</a>
7603901EA	ACTIVE	CDIP	J	16	1	Non-RoHS & Green	SNPB	N / A for Pkg Type	-55 to 125	7603901EA SNJ54LS123J	<a href="#">Samples</a>
7603901FA	ACTIVE	CFP	W	16	1	Non-RoHS & Green	SNPB	N / A for Pkg Type	-55 to 125	7603901FA SNJ54LS123W	<a href="#">Samples</a>
JM38510/01203BEA	ACTIVE	CDIP	J	16	1	Non-RoHS & Green	SNPB	N / A for Pkg Type	-55 to 125	JM38510/ 01203BEA	<a href="#">Samples</a>
JM38510/31401B2A	ACTIVE	LCCC	FK	20	1	Non-RoHS & Green	SNPB	N / A for Pkg Type	-55 to 125	JM38510/ 31401B2A	<a href="#">Samples</a>
JM38510/31401BEA	ACTIVE	CDIP	J	16	1	Non-RoHS & Green	SNPB	N / A for Pkg Type	-55 to 125	JM38510/ 31401BEA	<a href="#">Samples</a>
JM38510/31401BFA	ACTIVE	CFP	W	16	1	Non-RoHS & Green	SNPB	N / A for Pkg Type	-55 to 125	JM38510/ 31401BFA	<a href="#">Samples</a>
M38510/01203BEA	ACTIVE	CDIP	J	16	1	Non-RoHS & Green	SNPB	N / A for Pkg Type	-55 to 125	JM38510/ 01203BEA	<a href="#">Samples</a>
M38510/31401B2A	ACTIVE	LCCC	FK	20	1	Non-RoHS & Green	SNPB	N / A for Pkg Type	-55 to 125	JM38510/ 31401B2A	<a href="#">Samples</a>
M38510/31401BEA	ACTIVE	CDIP	J	16	1	Non-RoHS & Green	SNPB	N / A for Pkg Type	-55 to 125	JM38510/ 31401BEA	<a href="#">Samples</a>
M38510/31401BFA	ACTIVE	CFP	W	16	1	Non-RoHS & Green	SNPB	N / A for Pkg Type	-55 to 125	JM38510/ 31401BFA	<a href="#">Samples</a>
SN54123J	ACTIVE	CDIP	J	16	1	Non-RoHS & Green	SNPB	N / A for Pkg Type	-55 to 125	SN54123J	<a href="#">Samples</a>
SN54LS123J	ACTIVE	CDIP	J	16	1	Non-RoHS & Green	SNPB	N / A for Pkg Type	-55 to 125	SN54LS123J	<a href="#">Samples</a>
SN74123N	ACTIVE	PDIP	N	16	25	RoHS & Green	NIPDAU	N / A for Pkg Type	0 to 70	SN74123N	<a href="#">Samples</a>
SN74LS122D	ACTIVE	SOIC	D	14	50	RoHS & Green	NIPDAU	Level-1-260C-UNLIM	0 to 70	LS122	<a href="#">Samples</a>

Orderable Device	Status (1)	Package Type	Package Drawing	Pins	Package Qty	Eco Plan (2)	Lead finish/ Ball material (6)	MSL Peak Temp (3)	Op Temp (°C)	Device Marking (4/5)	Samples
SN74LS122DR	ACTIVE	SOIC	D	14	2500	RoHS & Green	NIPDAU	Level-1-260C-UNLIM	0 to 70	LS122	<a href="#">Samples</a>
SN74LS122DRE4	ACTIVE	SOIC	D	14	2500	RoHS & Green	NIPDAU	Level-1-260C-UNLIM	0 to 70	LS122	<a href="#">Samples</a>
SN74LS122N	ACTIVE	PDIP	N	14	25	RoHS & Green	NIPDAU	N / A for Pkg Type	0 to 70	SN74LS122N	<a href="#">Samples</a>
SN74LS122NSR	ACTIVE	SO	NS	14	2000	RoHS & Green	NIPDAU	Level-1-260C-UNLIM	0 to 70	74LS122	<a href="#">Samples</a>
SN74LS123D	ACTIVE	SOIC	D	16	40	RoHS & Green	NIPDAU	Level-1-260C-UNLIM	0 to 70	LS123	<a href="#">Samples</a>
SN74LS123DBR	ACTIVE	SSOP	DB	16	2000	RoHS & Green	NIPDAU	Level-1-260C-UNLIM		LS123	<a href="#">Samples</a>
SN74LS123DE4	ACTIVE	SOIC	D	16	40	RoHS & Green	NIPDAU	Level-1-260C-UNLIM	0 to 70	LS123	<a href="#">Samples</a>
SN74LS123DR	ACTIVE	SOIC	D	16	2500	RoHS & Green	NIPDAU	Level-1-260C-UNLIM	0 to 70	LS123	<a href="#">Samples</a>
SN74LS123DRG4	ACTIVE	SOIC	D	16	2500	RoHS & Green	NIPDAU	Level-1-260C-UNLIM	0 to 70	LS123	<a href="#">Samples</a>
SN74LS123N	ACTIVE	PDIP	N	16	25	RoHS & Green	NIPDAU	N / A for Pkg Type	0 to 70	SN74LS123N	<a href="#">Samples</a>
SN74LS123NE4	ACTIVE	PDIP	N	16	25	RoHS & Green	NIPDAU	N / A for Pkg Type	0 to 70	SN74LS123N	<a href="#">Samples</a>
SN74LS123NSR	ACTIVE	SO	NS	16	2000	RoHS & Green	NIPDAU	Level-1-260C-UNLIM	0 to 70	74LS123	<a href="#">Samples</a>
SN74LS123NSRG4	ACTIVE	SO	NS	16	2000	RoHS & Green	NIPDAU	Level-1-260C-UNLIM	0 to 70	74LS123	<a href="#">Samples</a>
SNJ54123J	ACTIVE	CDIP	J	16	1	Non-RoHS & Green	SNPB	N / A for Pkg Type	-55 to 125	SNJ54123J	<a href="#">Samples</a>
SNJ54123W	ACTIVE	CFP	W	16	1	Non-RoHS & Green	SNPB	N / A for Pkg Type	-55 to 125	SNJ54123W	<a href="#">Samples</a>
SNJ54LS123FK	ACTIVE	LCCC	FK	20	1	Non-RoHS & Green	SNPB	N / A for Pkg Type	-55 to 125	SNJ54LS 123FK	<a href="#">Samples</a>
SNJ54LS123J	ACTIVE	CDIP	J	16	1	Non-RoHS & Green	SNPB	N / A for Pkg Type	-55 to 125	7603901EA SNJ54LS123J	<a href="#">Samples</a>
SNJ54LS123W	ACTIVE	CFP	W	16	1	Non-RoHS & Green	SNPB	N / A for Pkg Type	-55 to 125	7603901FA SNJ54LS123W	<a href="#">Samples</a>

(1) The marketing status values are defined as follows:

**ACTIVE:** Product device recommended for new designs.

**LIFEBUY:** TI has announced that the device will be discontinued, and a lifetime-buy period is in effect.

**NRND:** Not recommended for new designs. Device is in production to support existing customers, but TI does not recommend using this part in a new design.

**PREVIEW:** Device has been announced but is not in production. Samples may or may not be available.

**OBSOLETE:** TI has discontinued the production of the device.

<sup>(2)</sup> **RoHS:** TI defines "RoHS" to mean semiconductor products that are compliant with the current EU RoHS requirements for all 10 RoHS substances, including the requirement that RoHS substance do not exceed 0.1% by weight in homogeneous materials. Where designed to be soldered at high temperatures, "RoHS" products are suitable for use in specified lead-free processes. TI may reference these types of products as "Pb-Free".

**RoHS Exempt:** TI defines "RoHS Exempt" to mean products that contain lead but are compliant with EU RoHS pursuant to a specific EU RoHS exemption.

**Green:** TI defines "Green" to mean the content of Chlorine (Cl) and Bromine (Br) based flame retardants meet JS709B low halogen requirements of <=1000ppm threshold. Antimony trioxide based flame retardants must also meet the <=1000ppm threshold requirement.

<sup>(3)</sup> **MSL, Peak Temp.** - The Moisture Sensitivity Level rating according to the JEDEC industry standard classifications, and peak solder temperature.

<sup>(4)</sup> There may be additional marking, which relates to the logo, the lot trace code information, or the environmental category on the device.

<sup>(5)</sup> Multiple Device Markings will be inside parentheses. Only one Device Marking contained in parentheses and separated by a "~" will appear on a device. If a line is indented then it is a continuation of the previous line and the two combined represent the entire Device Marking for that device.

<sup>(6)</sup> **Lead finish/Ball material** - Orderable Devices may have multiple material finish options. Finish options are separated by a vertical ruled line. Lead finish/Ball material values may wrap to two lines if the finish value exceeds the maximum column width.

**Important Information and Disclaimer:**The information provided on this page represents TI's knowledge and belief as of the date that it is provided. TI bases its knowledge and belief on information provided by third parties, and makes no representation or warranty as to the accuracy of such information. Efforts are underway to better integrate information from third parties. TI has taken and continues to take reasonable steps to provide representative and accurate information but may not have conducted destructive testing or chemical analysis on incoming materials and chemicals. TI and TI suppliers consider certain information to be proprietary, and thus CAS numbers and other limited information may not be available for release.

In no event shall TI's liability arising out of such information exceed the total purchase price of the TI part(s) at issue in this document sold by TI to Customer on an annual basis.

**OTHER QUALIFIED VERSIONS OF SN54123, SN54LS123, SN54LS123-SP, SN74123, SN74LS123 :**

● Catalog : [SN74123](#), [SN74LS123](#), [SN54LS123](#)

● Military : [SN54123](#), [SN54LS123](#)

● Space : [SN54LS123-SP](#)

NOTE: Qualified Version Definitions:

- Catalog - TI's standard catalog product
- Military - QML certified for Military and Defense Applications
- Space - Radiation tolerant, ceramic packaging and qualified for use in Space-based application

**TAPE AND REEL INFORMATION**

**QUADRANT ASSIGNMENTS FOR PIN 1 ORIENTATION IN TAPE**

\*All dimensions are nominal

Device	Package Type	Package Drawing	Pins	SPQ	Reel Diameter (mm)	Reel Width W1 (mm)	A0 (mm)	B0 (mm)	K0 (mm)	P1 (mm)	W (mm)	Pin1 Quadrant
SN74LS122DR	SOIC	D	14	2500	330.0	16.4	6.5	9.0	2.1	8.0	16.0	Q1
SN74LS122NSR	SO	NS	14	2000	330.0	16.4	8.2	10.5	2.5	12.0	16.0	Q1
SN74LS123DBR	SSOP	DB	16	2000	330.0	16.4	8.35	6.6	2.4	12.0	16.0	Q1
SN74LS123DR	SOIC	D	16	2500	330.0	16.4	6.5	10.3	2.1	8.0	16.0	Q1
SN74LS123NSR	SO	NS	16	2000	330.0	16.4	8.2	10.5	2.5	12.0	16.0	Q1

**TAPE AND REEL BOX DIMENSIONS**

\*All dimensions are nominal

Device	Package Type	Package Drawing	Pins	SPQ	Length (mm)	Width (mm)	Height (mm)
SN74LS122DR	SOIC	D	14	2500	356.0	356.0	35.0
SN74LS122NSR	SO	NS	14	2000	356.0	356.0	35.0
SN74LS123DBR	SSOP	DB	16	2000	356.0	356.0	35.0
SN74LS123DR	SOIC	D	16	2500	340.5	336.1	32.0
SN74LS123NSR	SO	NS	16	2000	356.0	356.0	35.0

**TUBE**

\*All dimensions are nominal

Device	Package Name	Package Type	Pins	SPQ	L (mm)	W (mm)	T (μm)	B (mm)
5962-7603901VFA	W	CFP	16	1	506.98	26.16	6220	NA
JM38510/31401B2A	FK	LCCC	20	1	506.98	12.06	2030	NA
JM38510/31401BFA	W	CFP	16	1	506.98	26.16	6220	NA
M38510/31401B2A	FK	LCCC	20	1	506.98	12.06	2030	NA
M38510/31401BFA	W	CFP	16	1	506.98	26.16	6220	NA
SN74123N	N	PDIP	16	25	506	13.97	11230	4.32
SN74123N	N	PDIP	16	25	506	13.97	11230	4.32
SN74LS122D	D	SOIC	14	50	506.6	8	3940	4.32
SN74LS122N	N	PDIP	14	25	506	13.97	11230	4.32
SN74LS122N	N	PDIP	14	25	506	13.97	11230	4.32
SN74LS123D	D	SOIC	16	40	507	8	3940	4.32
SN74LS123DE4	D	SOIC	16	40	507	8	3940	4.32
SN74LS123N	N	PDIP	16	25	506	13.97	11230	4.32
SN74LS123N	N	PDIP	16	25	506	13.97	11230	4.32
SN74LS123NE4	N	PDIP	16	25	506	13.97	11230	4.32
SN74LS123NE4	N	PDIP	16	25	506	13.97	11230	4.32
SNJ54123W	W	CFP	16	1	506.98	26.16	6220	NA
SNJ54LS123FK	FK	LCCC	20	1	506.98	12.06	2030	NA





# PACKAGE OUTLINE

## NS0016A

### SOP - 2.00 mm max height

SOP



4220735/A 12/2021

#### NOTES:

1. All linear dimensions are in millimeters. Dimensions in parenthesis are for reference only. Dimensioning and tolerancing per ASME Y14.5M.
2. This drawing is subject to change without notice.
3. This dimension does not include mold flash, protrusions, or gate burrs. Mold flash, protrusions, or gate burrs shall not exceed 0.15 mm, per side.
4. This dimension does not include interlead flash. Interlead flash shall not exceed 0.25 mm, per side.

# EXAMPLE BOARD LAYOUT

NS0016A

SOP - 2.00 mm max height

SOP



SOLDER MASK DETAILS

4220735/A 12/2021

NOTES: (continued)

5. Publication IPC-7351 may have alternate designs.

6. Solder mask tolerances between and around signal pads can vary based on board fabrication site.

# EXAMPLE STENCIL DESIGN

NS0016A

SOP - 2.00 mm max height

SOP



SOLDER PASTE EXAMPLE  
BASED ON 0.125 mm THICK STENCIL  
SCALE:7X

4220735/A 12/2021

NOTES: (continued)

7. Laser cutting apertures with trapezoidal walls and rounded corners may offer better paste release. IPC-7525 may have alternate design recommendations.
8. Board assembly site may have different recommendations for stencil design.

D (R-PDSO-G16)

PLASTIC SMALL OUTLINE



- NOTES:
- A. All linear dimensions are in inches (millimeters).
  - B. This drawing is subject to change without notice.
  - C. Body length does not include mold flash, protrusions, or gate burrs. Mold flash, protrusions, or gate burrs shall not exceed 0.006 (0,15) each side.
  - D. Body width does not include interlead flash. Interlead flash shall not exceed 0.017 (0,43) each side.
  - E. Reference JEDEC MS-012 variation AC.

D (R-PDSO-G16)

PLASTIC SMALL OUTLINE



- NOTES:
- All linear dimensions are in millimeters.
  - This drawing is subject to change without notice.
  - Publication IPC-7351 is recommended for alternate designs.
  - Laser cutting apertures with trapezoidal walls and also rounding corners will offer better paste release. Customers should contact their board assembly site for stencil design recommendations. Refer to IPC-7525 for other stencil recommendations.
  - Customers should contact their board fabrication site for solder mask tolerances between and around signal pads.

# DB0016A



# PACKAGE OUTLINE

## SSOP - 2 mm max height

SMALL OUTLINE PACKAGE



4220763/A 05/2022

### NOTES:

- All linear dimensions are in millimeters. Any dimensions in parenthesis are for reference only. Dimensioning and tolerancing per ASME Y14.5M.
- This drawing is subject to change without notice.
- This dimension does not include mold flash, protrusions, or gate burrs. Mold flash, protrusions, or gate burrs shall not exceed 0.15 mm per side.
- Reference JEDEC registration MO-150.

# EXAMPLE BOARD LAYOUT

DB0016A

SSOP - 2 mm max height

SMALL OUTLINE PACKAGE



LAND PATTERN EXAMPLE  
EXPOSED METAL SHOWN  
SCALE: 10X



4220763/A 05/2022

NOTES: (continued)

- 5. Publication IPC-7351 may have alternate designs.
- 6. Solder mask tolerances between and around signal pads can vary based on board fabrication site.

# EXAMPLE STENCIL DESIGN

DB0016A

SSOP - 2 mm max height

SMALL OUTLINE PACKAGE



SOLDER PASTE EXAMPLE  
BASED ON 0.125 mm THICK STENCIL  
SCALE: 10X

4220763/A 05/2022

NOTES: (continued)

7. Laser cutting apertures with trapezoidal walls and rounded corners may offer better paste release. IPC-7525 may have alternate design recommendations.
8. Board assembly site may have different recommendations for stencil design.



# MECHANICAL DATA

NS (R-PDSO-G\*\*)

PLASTIC SMALL-OUTLINE PACKAGE

14-PINS SHOWN



- NOTES:
- All linear dimensions are in millimeters.
  - This drawing is subject to change without notice.
  - Body dimensions do not include mold flash or protrusion, not to exceed 0,15.

W (R-GDFP-F16)

CERAMIC DUAL FLATPACK



- NOTES:
- A. All linear dimensions are in inches (millimeters).
  - B. This drawing is subject to change without notice.
  - C. This package can be hermetically sealed with a ceramic lid using glass frit.
  - D. Index point is provided on cap for terminal identification only.
  - E. Falls within MIL STD 1835 GDFP2-F16

## GENERIC PACKAGE VIEW

**FK 20**

**LCCC - 2.03 mm max height**

8.89 x 8.89, 1.27 mm pitch

LEADLESS CERAMIC CHIP CARRIER

This image is a representation of the package family, actual package may vary.  
Refer to the product data sheet for package details.



4229370VA\

J (R-GDIP-T\*\*)

14 LEADS SHOWN

CERAMIC DUAL IN-LINE PACKAGE



DIM \ PINS **	14	16	18	20
A	0.300 (7,62) BSC	0.300 (7,62) BSC	0.300 (7,62) BSC	0.300 (7,62) BSC
B MAX	0.785 (19,94)	.840 (21,34)	0.960 (24,38)	1.060 (26,92)
B MIN	—	—	—	—
C MAX	0.300 (7,62)	0.300 (7,62)	0.310 (7,87)	0.300 (7,62)
C MIN	0.245 (6,22)	0.245 (6,22)	0.220 (5,59)	0.245 (6,22)



4040083/F 03/03

- NOTES:
- A. All linear dimensions are in inches (millimeters).
  - B. This drawing is subject to change without notice.
  - C. This package is hermetically sealed with a ceramic lid using glass frit.
  - D. Index point is provided on cap for terminal identification only on press ceramic glass frit seal only.
  - E. Falls within MIL STD 1835 GDIP1-T14, GDIP1-T16, GDIP1-T18 and GDIP1-T20.

D (R-PDSO-G14)

PLASTIC SMALL OUTLINE



- NOTES:
- A. All linear dimensions are in inches (millimeters).
  - B. This drawing is subject to change without notice.
  - Body length does not include mold flash, protrusions, or gate burrs. Mold flash, protrusions, or gate burrs shall not exceed 0.006 (0,15) each side.
  - Body width does not include interlead flash. Interlead flash shall not exceed 0.017 (0,43) each side.
  - E. Reference JEDEC MS-012 variation AB.

D (R-PDSO-G14)

PLASTIC SMALL OUTLINE



- NOTES:
- All linear dimensions are in millimeters.
  - This drawing is subject to change without notice.
  - Publication IPC-7351 is recommended for alternate designs.
  - Laser cutting apertures with trapezoidal walls and also rounding corners will offer better paste release. Customers should contact their board assembly site for stencil design recommendations. Refer to IPC-7525 for other stencil recommendations.
  - Customers should contact their board fabrication site for solder mask tolerances between and around signal pads.

N (R-PDIP-T\*\*)

PLASTIC DUAL-IN-LINE PACKAGE

16 PINS SHOWN



- NOTES:
- A. All linear dimensions are in inches (millimeters).
  - B. This drawing is subject to change without notice.
  - C Falls within JEDEC MS-001, except 18 and 20 pin minimum body length (Dim A).
  - D The 20 pin end lead shoulder width is a vendor option, either half or full width.

4040049/E 12/2002

## IMPORTANT NOTICE AND DISCLAIMER

TI PROVIDES TECHNICAL AND RELIABILITY DATA (INCLUDING DATA SHEETS), DESIGN RESOURCES (INCLUDING REFERENCE DESIGNS), APPLICATION OR OTHER DESIGN ADVICE, WEB TOOLS, SAFETY INFORMATION, AND OTHER RESOURCES "AS IS" AND WITH ALL FAULTS, AND DISCLAIMS ALL WARRANTIES, EXPRESS AND IMPLIED, INCLUDING WITHOUT LIMITATION ANY IMPLIED WARRANTIES OF MERCHANTABILITY, FITNESS FOR A PARTICULAR PURPOSE OR NON-INFRINGEMENT OF THIRD PARTY INTELLECTUAL PROPERTY RIGHTS.

These resources are intended for skilled developers designing with TI products. You are solely responsible for (1) selecting the appropriate TI products for your application, (2) designing, validating and testing your application, and (3) ensuring your application meets applicable standards, and any other safety, security, regulatory or other requirements.

These resources are subject to change without notice. TI grants you permission to use these resources only for development of an application that uses the TI products described in the resource. Other reproduction and display of these resources is prohibited. No license is granted to any other TI intellectual property right or to any third party intellectual property right. TI disclaims responsibility for, and you will fully indemnify TI and its representatives against, any claims, damages, costs, losses, and liabilities arising out of your use of these resources.

TI's products are provided subject to [TI's Terms of Sale](#) or other applicable terms available either on [ti.com](https://www.ti.com) or provided in conjunction with such TI products. TI's provision of these resources does not expand or otherwise alter TI's applicable warranties or warranty disclaimers for TI products.

TI objects to and rejects any additional or different terms you may have proposed.

Mailing Address: Texas Instruments, Post Office Box 655303, Dallas, Texas 75265  
Copyright © 2023, Texas Instruments Incorporated