

3.2 W Mono Class-D Audio Power Amplifier With Selectable Gain and Auto-Recovering Short-Circuit Protection

Check for Samples: [TPA2038D1](#)

FEATURES

- Filter-Free Mono Class-D Speaker Amp
- GAIN Pin Selects Between 6 dB and 12 dB
- 3.2 W into 4 Ω from 5 V supply at 10% THD+N
- Powerful Mono Class-D Speaker Amplifier
 - 1% at 1.4 W into 8 Ω from 5 V Supply
 - 1% at 2.5 W into 4 Ω from 5 V Supply
- Integrated Image Reject Filter for DAC Noise Reduction
- Low Output Noise of 20 μV
- Low Quiescent Current of 1.5 mA
- Auto-Recovering Short-Circuit Protection
- Thermal-Overload Protection
- 9-Ball 1,21 mm × 1,16 mm 0,4 mm Pitch WCSP

APPLICATIONS

- Wireless or Cellular Handsets and PDAs
- Portable Navigation Devices
- General Portable Audio Devices

DESCRIPTION

The TPA2038D1 is a 3.2 W into 4-ohm (10% THD) high efficiency filter-free class-D audio power amplifier. The GAIN pin sets gain to either 6 dB or 12 dB.

Features like 95% efficiency, 1.5 mA quiescent current, 0.5 μA shutdown current, 81 dB PSRR, 20 μV output noise, and improved RF immunity make the TPA2038D1 class-D amplifier ideal for cellular handsets. A start-up time is within 4 ms with no turn-on pop.

The TPA2038D1 is available in a 1.21 mm x 1.16 mm, 0.4 mm pitch wafer chip scale package (WCSP).

APPLICATION CIRCUIT

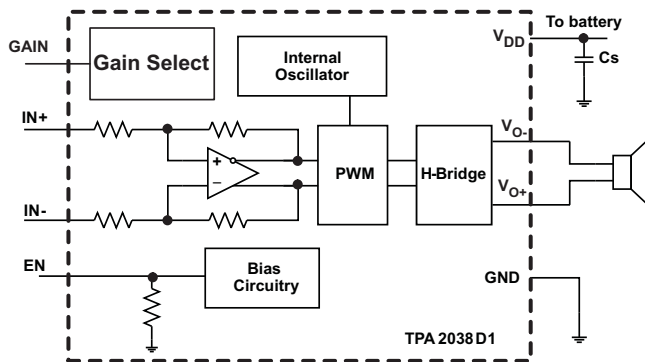

TPA2038D1
9-BALL 0.4mm PITCH
WAFER CHIP SCALE PACKAGE (YFF)
(TOP VIEW OF PCB)

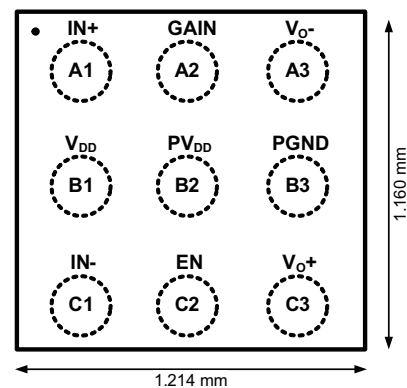

Please be aware that an important notice concerning availability, standard warranty, and use in critical applications of Texas Instruments semiconductor products and disclaimers thereto appears at the end of this data sheet.

TPA2038D1

SLOS697A – AUGUST 2011 – REVISED OCTOBER 2012

www.ti.com



These devices have limited built-in ESD protection. The leads should be shorted together or the device placed in conductive foam during storage or handling to prevent electrostatic damage to the MOS gates.

ORDERING INFORMATION

T _A	PACKAGED DEVICES ⁽¹⁾	PART NUMBER ⁽²⁾	SYMBOL
-40°C to 85°C	9-ball WCSP	TPA2038D1YFFR	QWK
		TPA2038D1YFFT	QWK

- (1) For the most current package and ordering information, see the Package Option Addendum at the end of this document, or see the TI Web site at www.ti.com
- (2) The YFF package is only available taped and reeled. The suffix "R" indicates a reel of 3000, the suffix "T" indicates a reel of 250.

ABSOLUTE MAXIMUM RATINGS

over operating free-air temperature range, T_A = 25°C (unless otherwise noted)⁽¹⁾

			VALUE	UNIT
V _{DD} , PV _{DD}	Supply voltage	In active mode	-0.3 to 6.0	V
		In shutdown mode	-0.3 to 6.0	V
V _I	Input voltage	EN, IN+, IN-	-0.3 to V _{DD} + 0.3	V
R _L	Minimum load resistance		3.2	Ω
	Output continuous total power dissipation		See Dissipation Rating Table	
T _A	Operating free-air temperature range		-40 to 85	°C
T _J	Operating junction temperature range		-40 to 150	°C
T _{stg}	Storage temperature range		-65 to 85	°C

- (1) Stresses beyond those listed under *absolute maximum ratings* may cause permanent damage to the device. These are stress ratings only, and functional operation of the device at these or any other conditions beyond those indicated under *recommended operating conditions* is not implied. Exposure to Absolute Maximum Ratings conditions for extended periods may affect device reliability.

DISSIPATION RATINGS

PACKAGE	DERATING FACTOR ⁽¹⁾	T _A < 25°C	T _A = 70°C	T _A = 85°C
YFF (WCSP)	4.2 mW/°C	525 mW	336 mW	273 mW

- (1) Derating factor measure with high K board.

RECOMMENDED OPERATING CONDITIONS

			MIN	MAX	UNIT
V _{DD} , PV _{DD}	Class-D supply voltage		2.5	5.5	V
V _{IH}	High-level input voltage	EN, GAIN	1.3		V
V _{IL}	Low-level input voltage	EN, GAIN		0.35	V
V _{IC}	Common mode input voltage range	V _{DD} = 2.5 V, 5.5 V, CMRR ≥ 49 dB	0.75	V _{DD} -1.1	V
T _A	Operating free-air temperature		-40	85	°C

GAIN SETTING

GAIN PIN	GAIN SETTING
GND	12 dB
VDD	6 dB

ELECTRICAL CHARACTERISTICS

 PVDD = VDD = 3.6 V, T_A = 25°C (unless otherwise noted)

PARAMETER		TEST CONDITIONS	MIN	TYP	MAX	UNIT
V _{OS}	Output offset voltage (measured differentially)	VDD = 2.5 V to 5.5 V, GAIN = VDD		1	5	mV
I _{IH}	High-level EN input current	VDD = 5.5 V, EN = GAIN = 5.5 V			50	μA
I _{IL}	Low-level EN input current	VDD = 5.5 V, EN = GAIN = 0 V			1	μA
I _(Q)	Quiescent current	VDD = 5.5 V, no load		1.8	2.5	mA
		VDD = 3.6 V, no load		1.5	2.3	
		VDD = 2.5 V, no load		1.3	2.1	
I _(SD)	Shutdown current	EN = 0.35 V, VDD = 3.6 V		0.1	2	μA
R _{O, SD}	Output impedance in shutdown mode	EN = 0.35 V		2		kΩ
f _(SW)	Switching frequency	VDD = 2.5 V to 5.5 V	250	300	350	kHz
A _V	Gain	GAIN = 0 V	11.5	12	12.5	dB
		GAIN = VDD	5.5	6	6.5	
R _{EN}	Resistance from EN to GND			300		kΩ
R _{IN}	Single-ended input resistance	A _V = 6 dB; EN = VDD		150		kΩ
		A _V = 12 dB; EN = VDD		75		
		EN = 0.35 V		75		

OPERATING CHARACTERISTICS

 PVDD = VDD = 3.6 V, A_V = 6 dB, T_A = 25°C, R_L = 8 Ω (unless otherwise noted)

PARAMETER		TEST CONDITIONS	MIN	TYP	MAX	UNIT
P _O	Output power	THD + N = 10%, f = 1 kHz, R _L = 4 Ω	V _{DD} = 5 V	3.24		W
			V _{DD} = 3.6 V	1.62		
			V _{DD} = 2.5 V	0.70		
		THD + N = 1%, f = 1 kHz, R _L = 4 Ω	V _{DD} = 5 V	2.57		W
			V _{DD} = 3.6 V	1.32		
			V _{DD} = 2.5 V	0.57		
		THD + N = 10%, f = 1 kHz, R _L = 8 Ω	V _{DD} = 5 V	1.80		W
			V _{DD} = 3.6 V	0.91		
			V _{DD} = 2.5 V	0.42		
		THD + N = 1%, f = 1 kHz, R _L = 8 Ω	V _{DD} = 5 V	1.46		W
			V _{DD} = 3.6 V	0.74		
			V _{DD} = 2.5 V	0.33		
E _N	Output voltage noise, A _V = 6 dB	V _{DD} = 3.6 V, Inputs AC grounded with C ₁ = 2 μF, f = 20 Hz to 20 kHz	A-weighting	20		μV _{RMS}
			No weighting	26		
	Output voltage noise, A _V = 12 dB		A-weighting	27		
			No weighting	36		
THD+N	Total harmonic distortion plus noise	VDD = 5.0 V, P _O = 1.0 W, f = 1 kHz, R _L = 8 Ω		0.12%		
		VDD = 3.6 V, P _O = 0.5 W, f = 1 kHz, R _L = 8 Ω		0.05%		
		VDD = 2.5 V, P _O = 0.2 W, f = 1 kHz, R _L = 8 Ω		0.05%		
		VDD = 5.0 V, P _O = 2.0 W, f = 1 kHz, R _L = 4 Ω		0.32%		
		VDD = 3.6 V, P _O = 1.0 W, f = 1 kHz, R _L = 4 Ω		0.11%		
		VDD = 2.5 V, P _O = 0.4 W, f = 1 kHz, R _L = 4 Ω		0.12%		
PSRR	AC power supply rejection ratio	A _V = 6 dB, Inputs AC grounded with C ₁ = 2 μF, 200 mV _{pp} ripple, f = 217 Hz		81		dB
		A _V = 12 dB, Inputs AC grounded with C ₁ = 2 μF, 200 mV _{pp} ripple, f = 217 Hz		82		

TPA2038D1

SLOS697A – AUGUST 2011 – REVISED OCTOBER 2012

www.ti.com

OPERATING CHARACTERISTICS (continued)

PVDD = VDD = 3.6 V, $A_V = 6$ dB, $T_A = 25^\circ\text{C}$, $R_L = 8 \Omega$ (unless otherwise noted)

PARAMETER		TEST CONDITIONS	MIN	TYP	MAX	UNIT
CMRR	Common mode rejection ratio	$A_V = 6$ dB, $V_{IC} = 200$ mV _{PP} , $f = 217$ Hz		79		dB
		$A_V = 12$ dB, $V_{IC} = 200$ mV _{PP} , $f = 217$ Hz		77		
T_{SU}	Startup time from shutdown			4		ms
I_{SC}	Short circuit protection threshold	V_{O+} shorted to VDD		2		A
		V_{O-} shorted to VDD				
		V_{O+} shorted to GND				
		V_{O-} shorted to GND				
		V_{O+} shorted to V_{O-}				
T_{AR}	Overcurrent recovery time	VDD = 2.5 V to 5.5 V		100		ms

Terminal Functions

TERMINAL		I/O	DESCRIPTION
NAME	WCSP BALL		
IN+	A1	I	Positive audio input.
GAIN	A2	I	Gain select. Set to GND for 12 dB; set to VDD for 6 dB.
V_{O-}	A3	O	Negative audio output.
VDD	B1	I	Power supply terminal. Connect to PVDD using a direct connection.
PVDD	B2	I	Class-D output power supply. Connect to VDD using a direct connection.
GND	B3	I	Ground.
IN-	C1	I	Negative audio input.
EN	C2	I	Enable. Set to logic high to enable device.
V_{O+}	C3	O	Positive audio output.

FUNCTIONAL BLOCK DIAGRAM

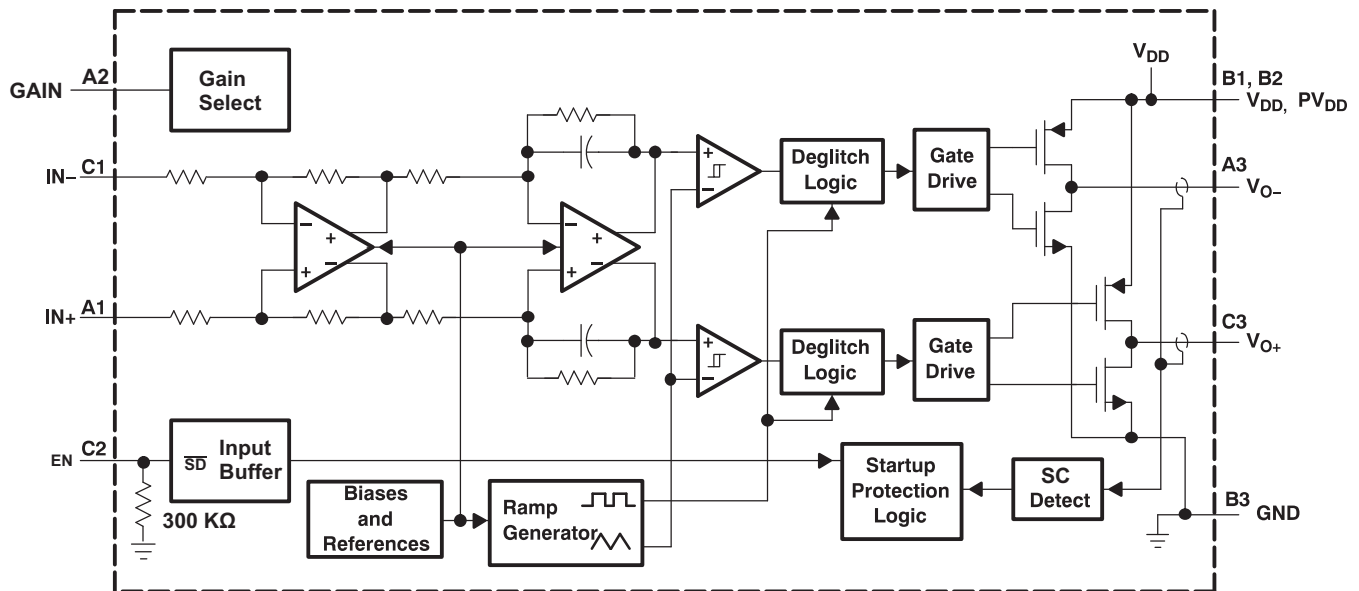

TEST SETUP FOR GRAPHS

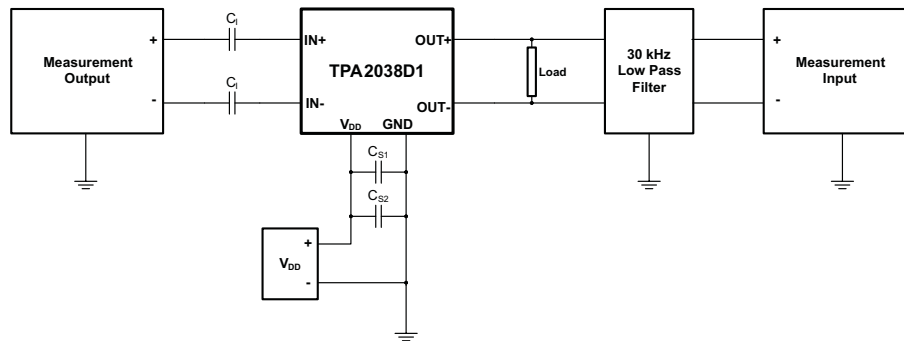

1. C_1 was shorted for any common-mode input voltage measurement. All other measurements were taken with $C_1 = 0.1 \mu\text{F}$ (unless otherwise noted).
2. $C_{S1} = 0.1 \mu\text{F}$ is placed very close to the device. The optional $C_{S2} = 10 \mu\text{F}$ is used for datasheet graphs.
3. The 30 kHz low-pass filter is required even if the analyzer has an internal low-pass filter. An RC low-pass filter (1 k Ω , 4700 pF) is used on each output for the data sheet graphs.

TYPICAL CHARACTERISTICS

PVDD = VDD = 3.6 V, C_I = 0.1 μF, C_{S1} = 0.1 μF, C_{S2} = 10 μF, T_A = 25°C, R_L = 8 Ω (unless otherwise noted)

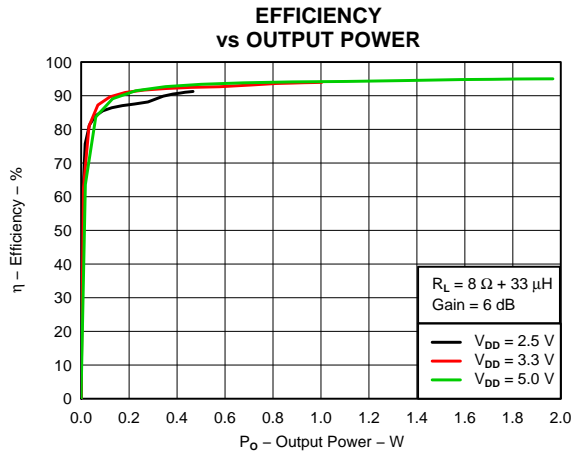

Figure 1.

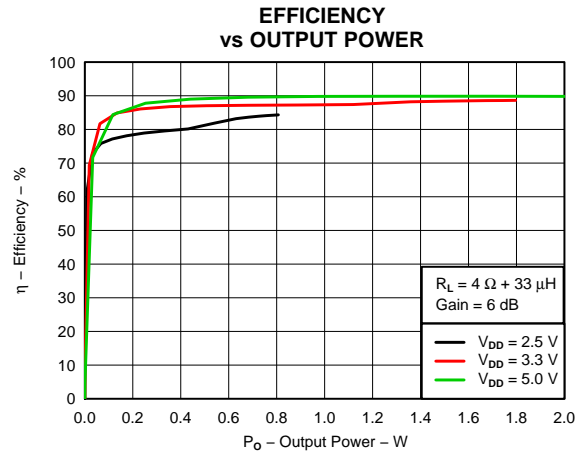

Figure 2.

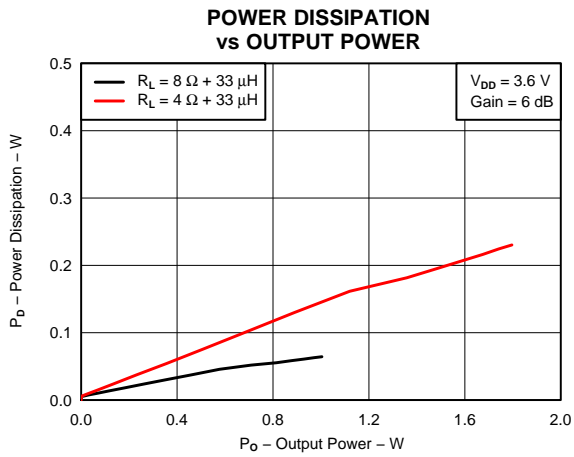

Figure 3.

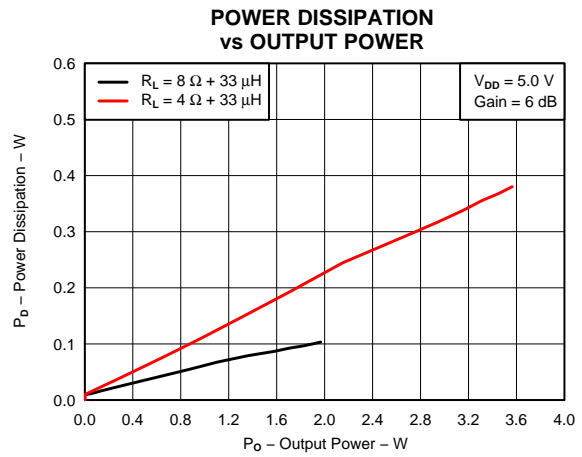

Figure 4.

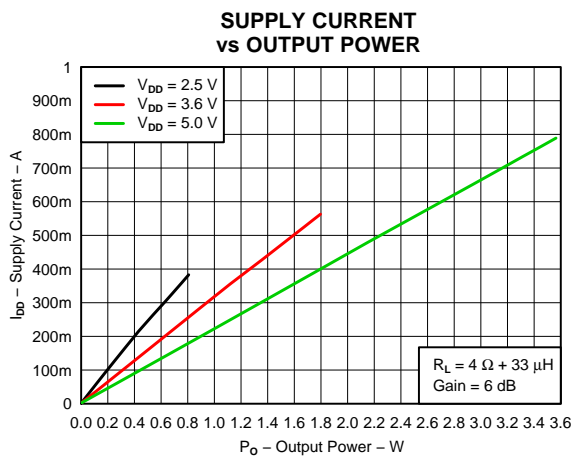

Figure 5.

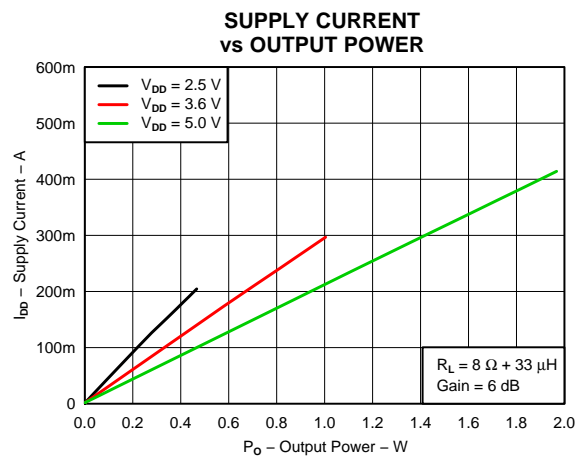

Figure 6.

TYPICAL CHARACTERISTICS (continued)

PVDD = VDD = 3.6 V, C_I = 0.1 μF, C_{S1} = 0.1 μF, C_{S2} = 10 μF, T_A = 25°C, R_L = 8 Ω (unless otherwise noted)

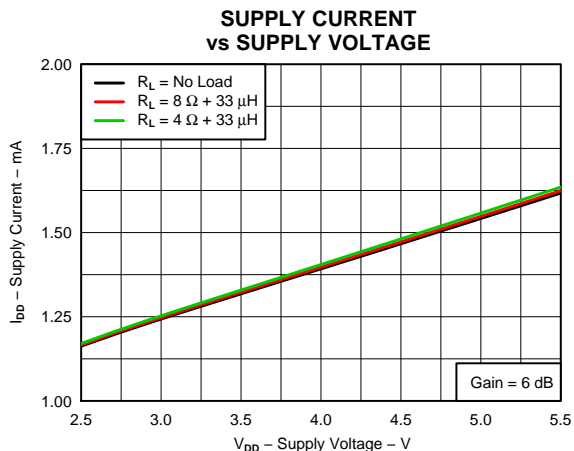

Figure 7.

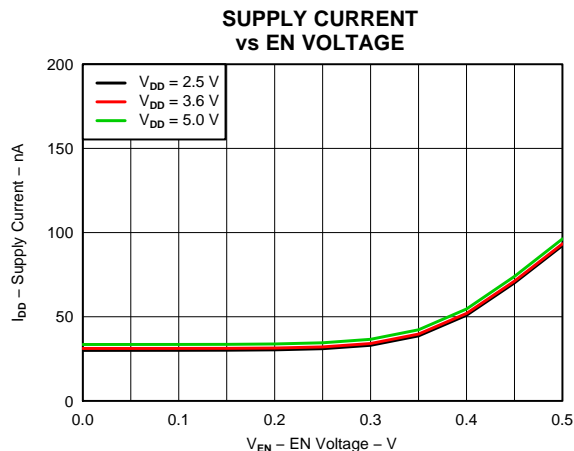

Figure 8.

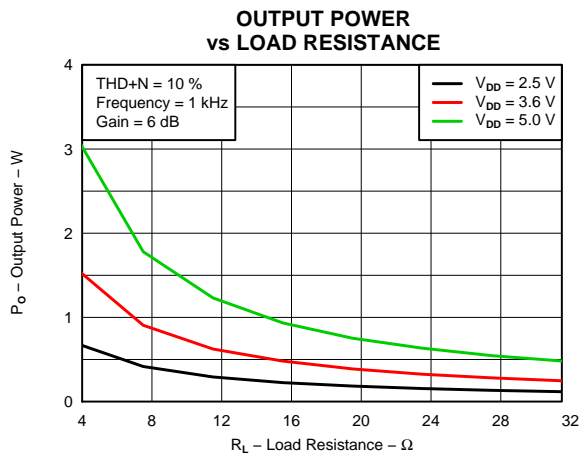

Figure 9.

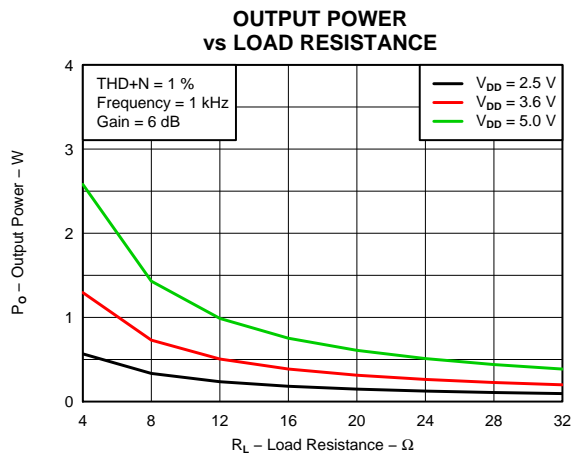

Figure 10.

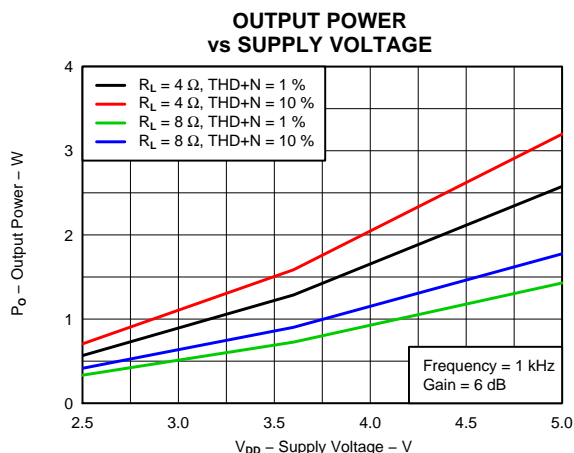

Figure 11.

TYPICAL CHARACTERISTICS (continued)

PVDD = VDD = 3.6 V, C_I = 0.1 μF, C_{S1} = 0.1 μF, C_{S2} = 10 μF, T_A = 25°C, R_L = 8 Ω (unless otherwise noted)

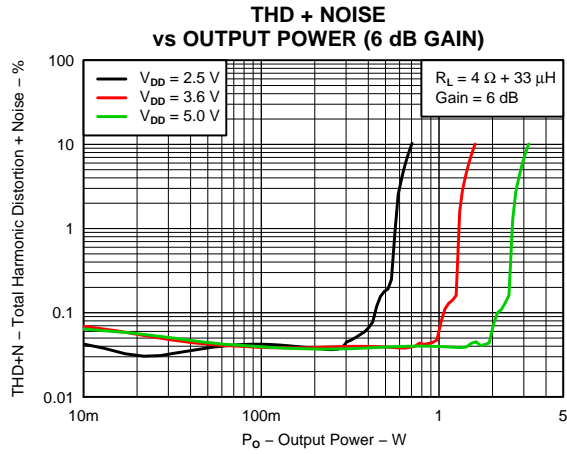

Figure 12.

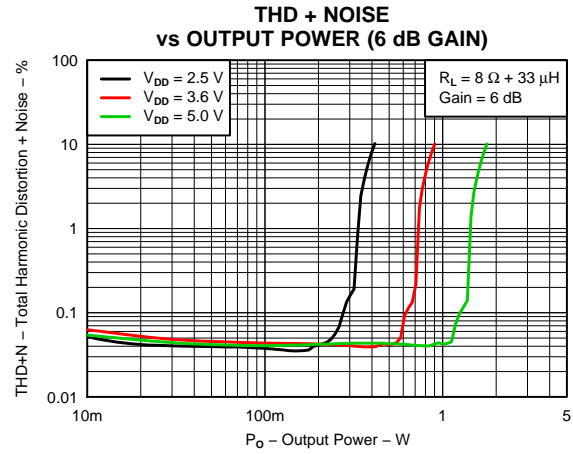

Figure 13.

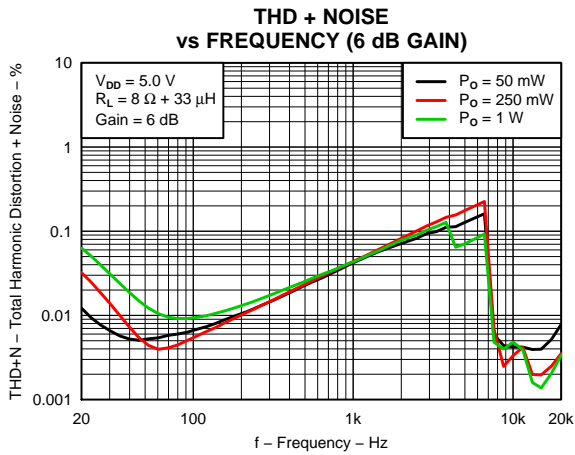

Figure 14.

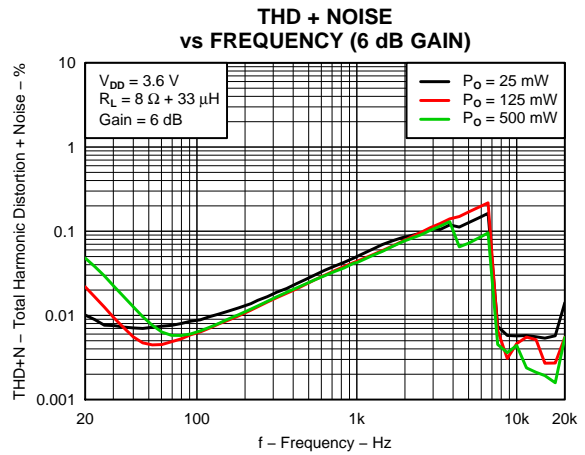

Figure 15.

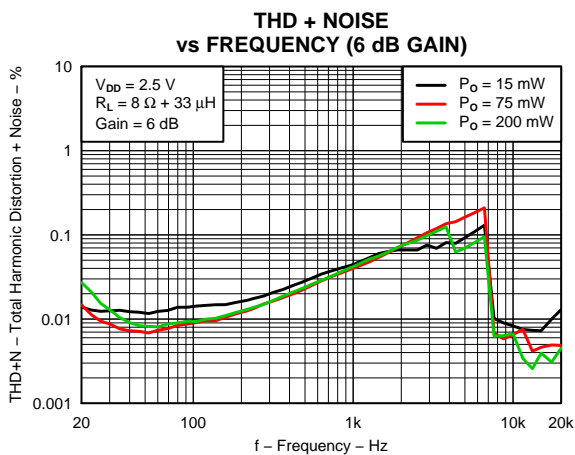

Figure 16.

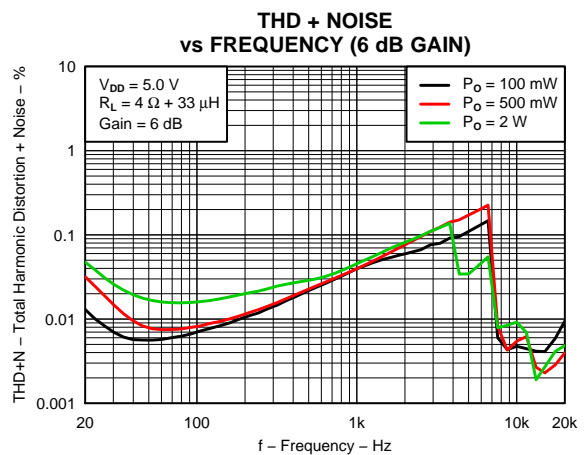

Figure 17.

TYPICAL CHARACTERISTICS (continued)

PVDD = VDD = 3.6 V, C_I = 0.1 μF, C_{S1} = 0.1 μF, C_{S2} = 10 μF, T_A = 25°C, R_L = 8 Ω (unless otherwise noted)

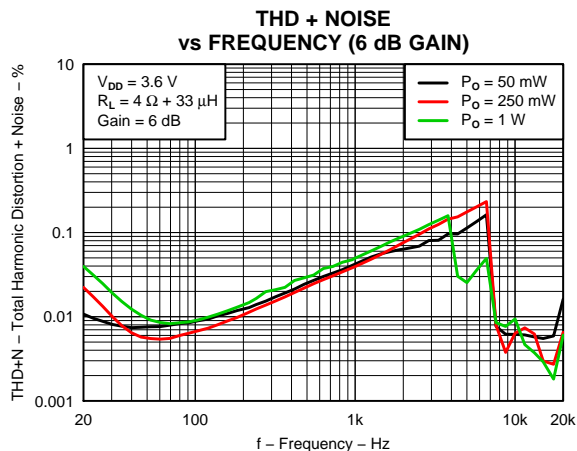

Figure 18.

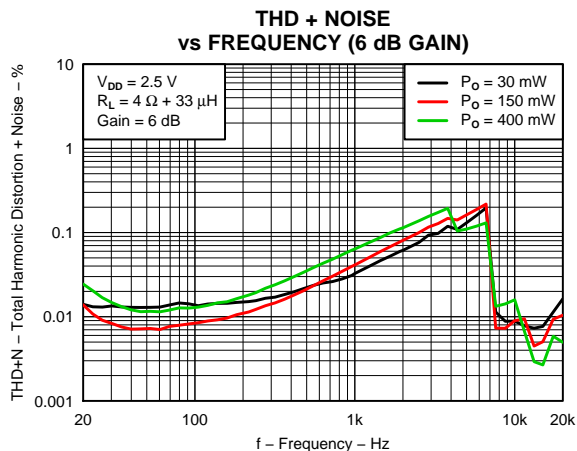

Figure 19.

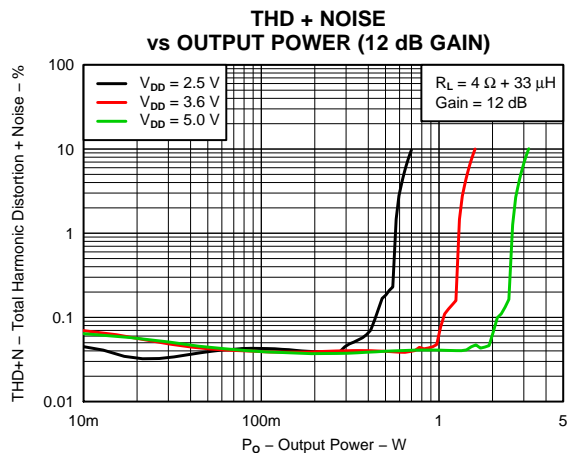

Figure 20.

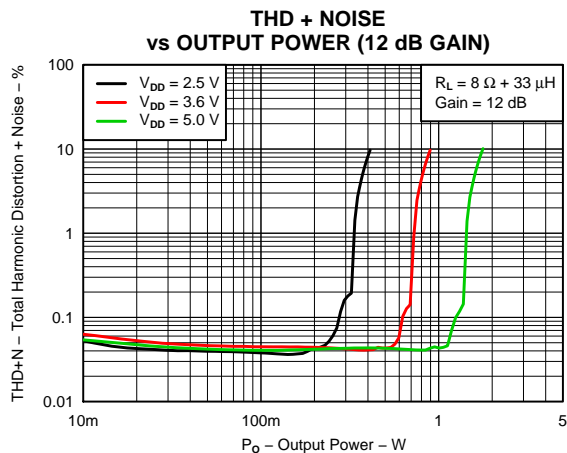

Figure 21.

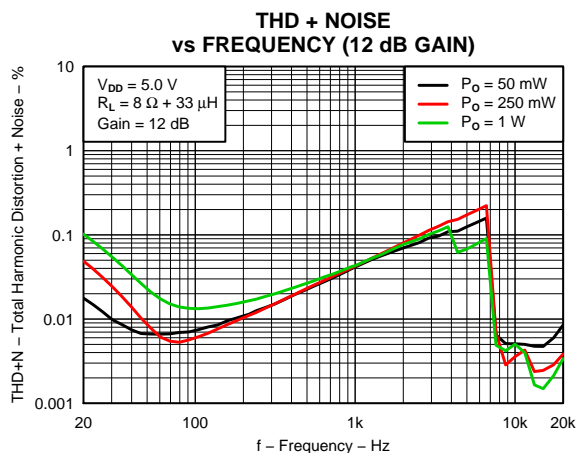

Figure 22.

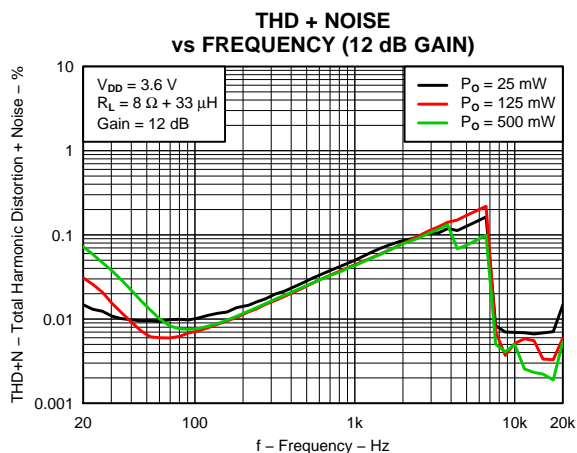

Figure 23.

TYPICAL CHARACTERISTICS (continued)

PVDD = VDD = 3.6 V, C_I = 0.1 μF, C_{S1} = 0.1 μF, C_{S2} = 10 μF, T_A = 25°C, R_L = 8 Ω (unless otherwise noted)

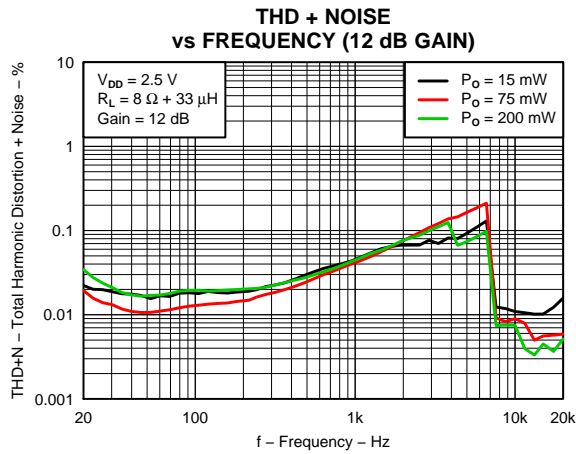

Figure 24.

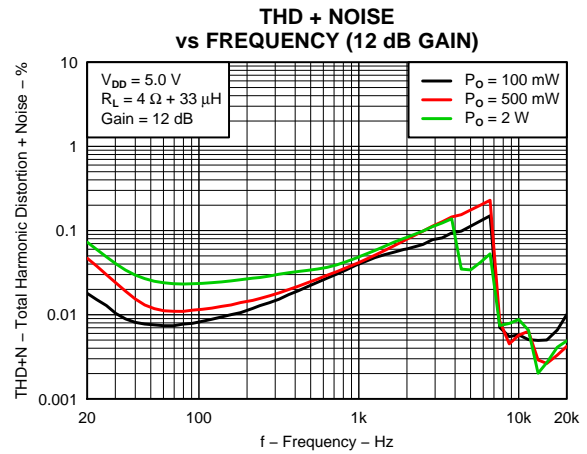

Figure 25.

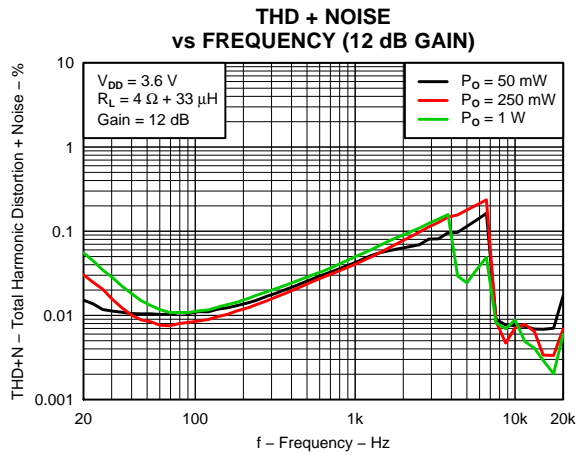

Figure 26.

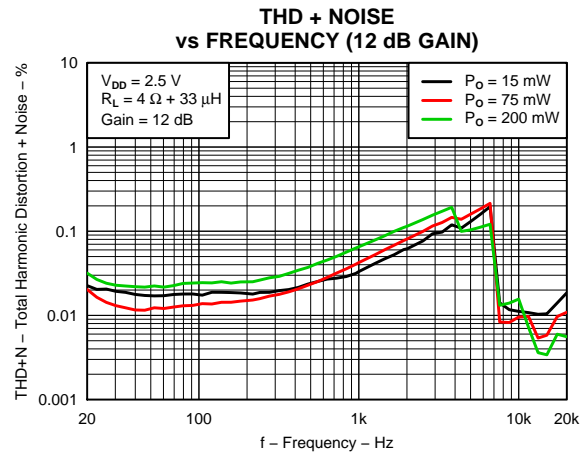

Figure 27.

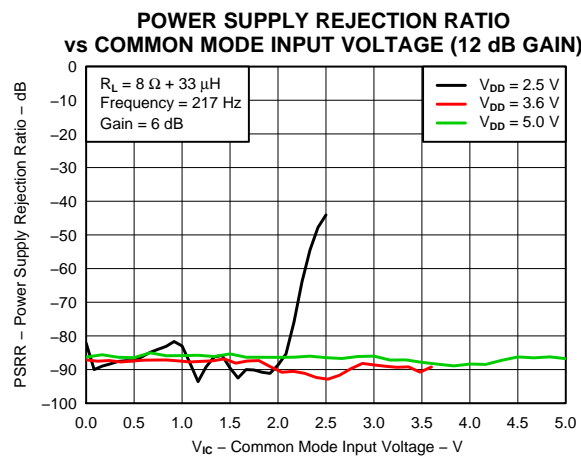

Figure 28.

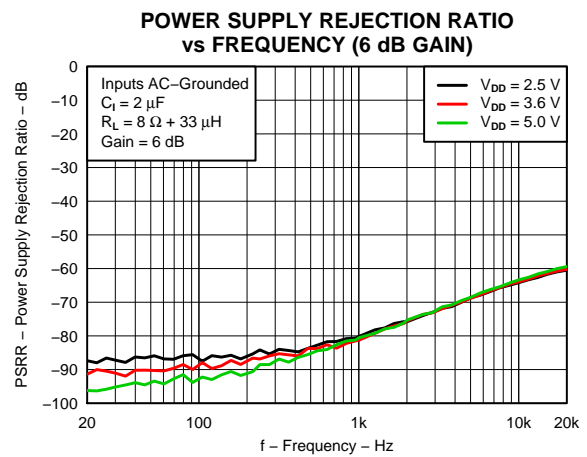

Figure 29.

TYPICAL CHARACTERISTICS (continued)

PVDD = VDD = 3.6 V, C_I = 0.1 μF, C_{S1} = 0.1 μF, C_{S2} = 10 μF, T_A = 25°C, R_L = 8 Ω (unless otherwise noted)

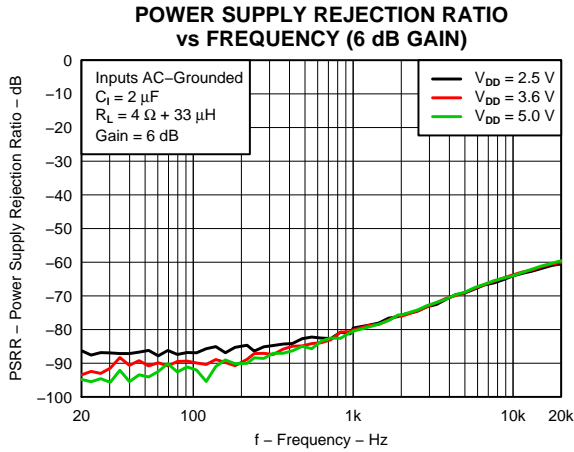

Figure 30.

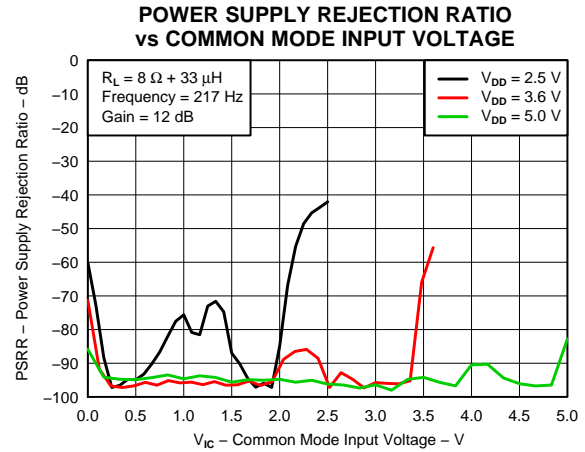

Figure 31.

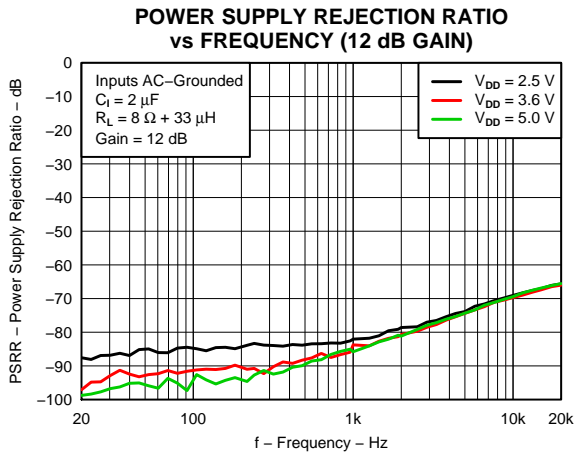

Figure 32.

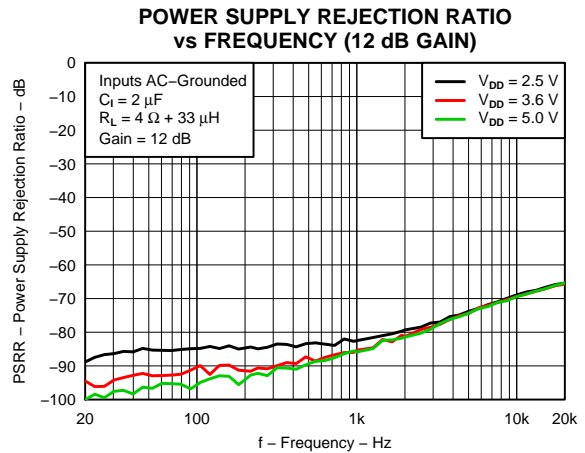

Figure 33.

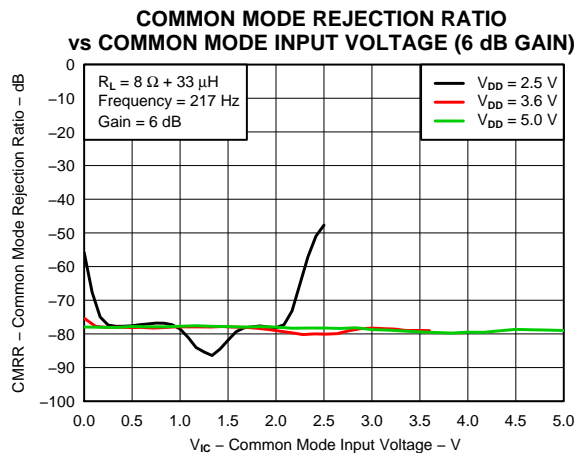

Figure 34.

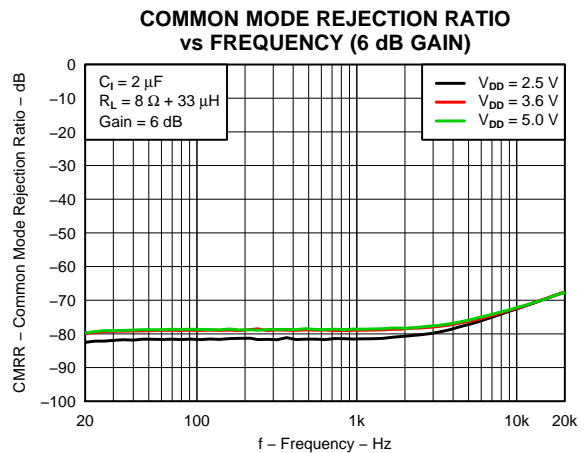

Figure 35.

TYPICAL CHARACTERISTICS (continued)

PVDD = VDD = 3.6 V, C_I = 0.1 μF, C_{S1} = 0.1 μF, C_{S2} = 10 μF, T_A = 25°C, R_L = 8 Ω (unless otherwise noted)

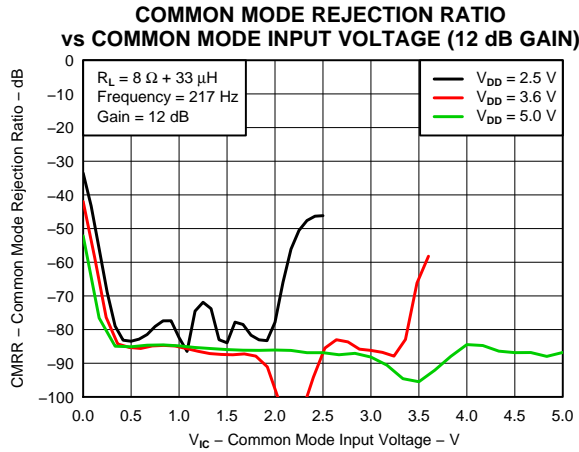

Figure 36.

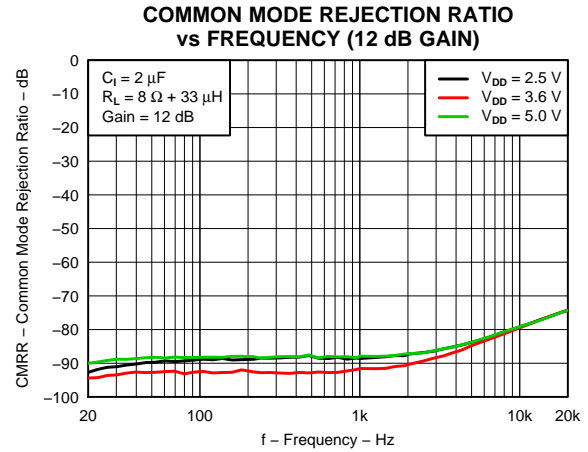

Figure 37.

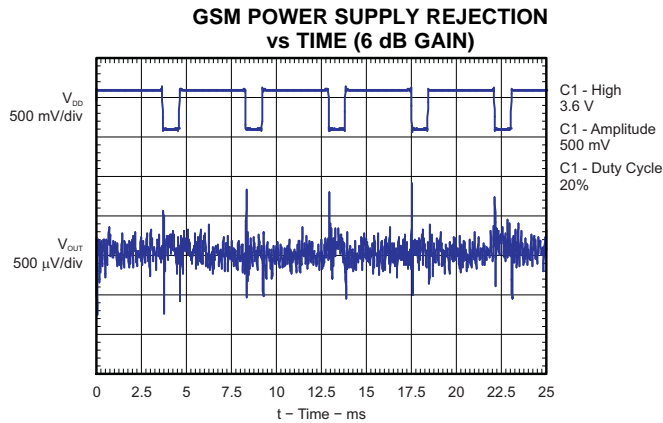

Figure 38.

G026

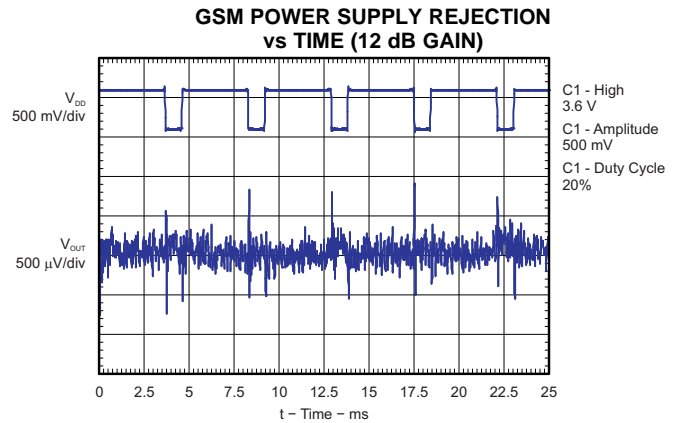

Figure 39.

G026

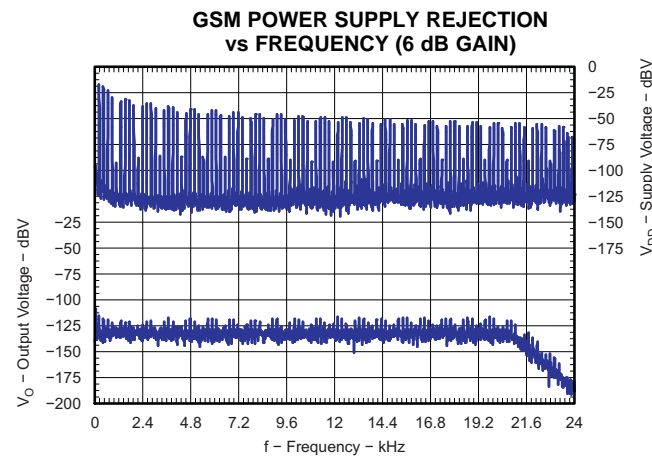

Figure 40.

G027

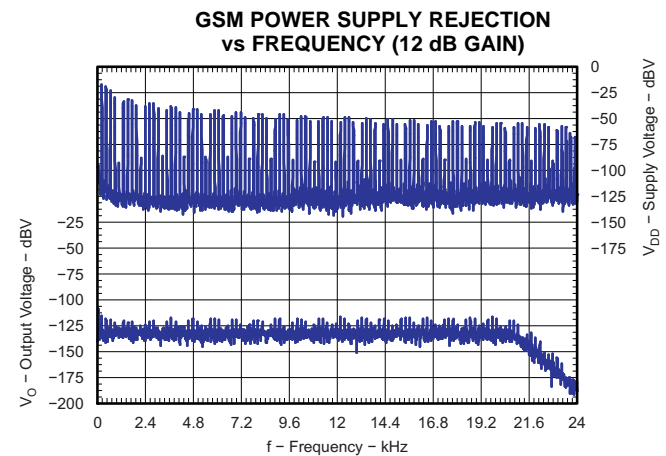

Figure 41.

G027

APPLICATION INFORMATION

SHORT CIRCUIT AUTO-RECOVERY

When a short-circuit event occurs, the TPA2038D1 goes to shutdown mode and activates the integrated auto-recovery process whose aim is to return the device to normal operation once the short-circuit is removed. This process repeatedly examines (once every 100 ms) whether the short-circuit condition persists, and returns the device to normal operation immediately after the short-circuit condition is removed. This feature helps protect the device from large currents and maintain a good long-term reliability.

INTEGRATED IMAGE REJECT FILTER FOR DAC NOISE REJECTION

In applications which use a DAC to drive Class-D amplifiers, out-of-band noise energy present at the DAC's image frequencies fold back into the audio-band at the output of the Class-D amplifier. An external low-pass filter is often placed between the DAC and the Class-D amplifier in order to attenuate this noise.

The TPA2038D1 has an integrated Image Reject Filter with a low-pass cutoff frequency of 130 kHz, which significantly attenuates this noise. Depending on the system noise specification, the integrated Image Reject Filter may help eliminate external filtering, thereby saving board space and component cost.

COMPONENT SELECTION

Figure 42 shows the TPA2038D1 typical schematic with differential inputs, while Figure 43 shows the TPA2038D1 with differential inputs and input capacitors. Figure 44 shows the TPA2038D1 with a single-ended input.

Decoupling Capacitors (C_{S1} , C_{S2})

The TPA2038D1 is a high-performance class-D audio amplifier that requires adequate power supply decoupling to ensure the efficiency is high and total harmonic distortion (THD) is low. For higher frequency transients, spikes, or digital hash on the line, a good low equivalent-series-resistance (ESR) ceramic capacitor $C_{S1} = 0.1 \mu\text{F}$, placed as close as possible to the device V_{DD} lead works best. Placing C_{S1} close to the TPA2038D1 is important for the efficiency of the class-D amplifier, because any resistance or inductance in the trace between the device and the capacitor can cause a loss in efficiency. For filtering lower-frequency noise signals, a $10 \mu\text{F}$ or greater capacitor (C_{S2}) placed near the audio power amplifier would also help, but it is not required in most applications because of the high PSRR of this device. Typically, the smaller the capacitor's case size, the lower the inductance and the closer it can be placed to the TPA2038D1. X5R and X7R dielectric capacitors are recommended for both C_{S1} and C_{S2} .

Input Capacitors (C_I)

The TPA2038D1 does not require input coupling capacitors if the design uses a differential source that is biased within the common-mode input voltage range. That voltage range is listed in the Recommended Operating Conditions table. If the input signal is not biased within the recommended common-mode input range, such as in needing to use the input as a high pass filter, shown in Figure 43, or if using a single-ended source, shown in Figure 44, input coupling capacitors are required. The same value capacitors should be used on both IN+ and IN– for best pop performance. The 3 dB high-pass cutoff frequency f_C of the filter formed by the input coupling capacitor C_I and the input resistance R_I (typically $150 \text{ k}\Omega$) of the TPA2038D1 is given by Equation 1:

$$f_C = \frac{1}{(2\pi R_I C_I)} \quad (1)$$

The value of the input capacitor is important to consider as it directly affects the bass (low frequency) performance of the circuit. Speaker response may also be taken into consideration when setting the corner frequency using input capacitors. Solving for the input coupling capacitance, we get:

$$C_I = \frac{1}{(2\pi R_I f_C)} \quad (2)$$

If the corner frequency is within the audio band, the capacitors should have a tolerance of $\pm 10\%$ or better, because any mismatch in capacitance causes an impedance mismatch at the corner frequency and below.

TPA2038D1

SLOS697A – AUGUST 2011 – REVISED OCTOBER 2012

www.ti.com

For a flat low-frequency response, use large input coupling capacitors (0.1 μF or larger). X5R and X7R dielectric capacitors are recommended.

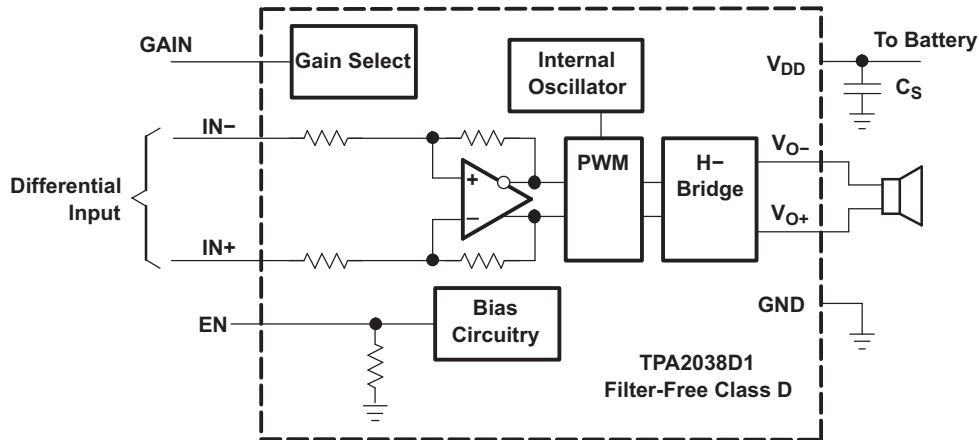

Figure 42. Typical TPA2038D1 Application Schematic With DC-coupled Differential Input

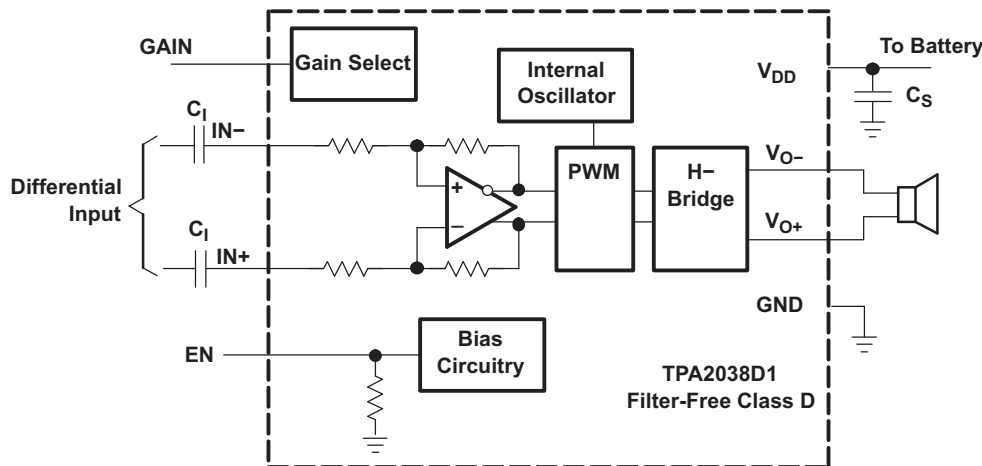

Figure 43. TPA2038D1 Application Schematic With Differential Input and Input Capacitors

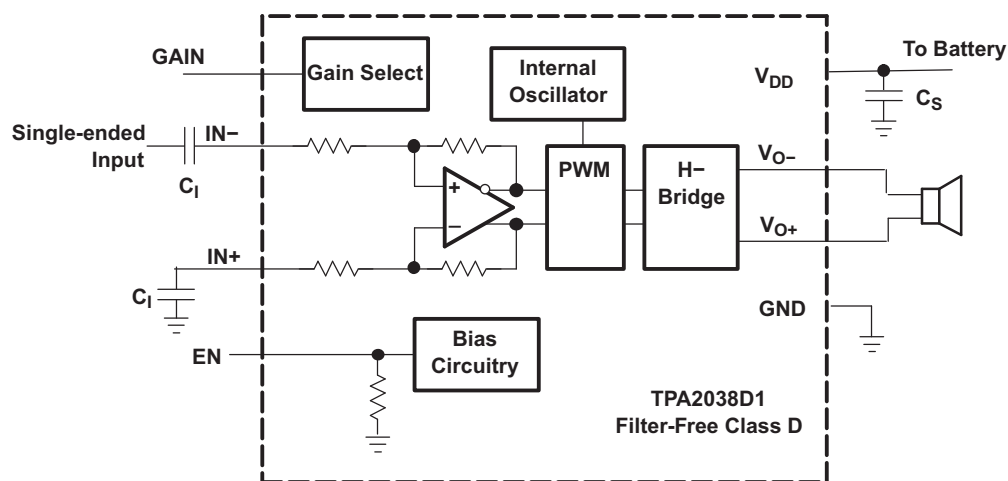

Figure 44. TPA2038D1 Application Schematic With Single-Ended Input

EFFICIENCY AND THERMAL INFORMATION

The maximum ambient operating temperature of the TPA2038D1 depends on the load resistance, power supply voltage and heat-sinking ability of the PCB system. The derating factor for the YFF package is shown in the dissipation rating table. Converting this to θ_{JA} :

$$\theta_{JA} = \frac{1}{\text{Derating Factor}} \quad (3)$$

Given θ_{JA} (from the Package Dissipation ratings table), the maximum allowable junction temperature (from the Absolute Maximum ratings table), and the maximum internal dissipation (from Power Dissipation vs Output Power figures) the maximum ambient temperature can be calculated with the following equation. Note that the units on these figures are Watts RMS. Because audio contains crest factors (ratio of peak power to RMS power) from 9–15 dB, thermal limitations are not usually encountered.

$$T_{A\text{Max}} = T_{J\text{Max}} - \theta_{JA} P_{D\text{max}} \quad (4)$$

The TPA2038D1 is designed with thermal protection that turns the device off when the junction temperature surpasses 150°C to prevent damage to the IC. Note that the use of speakers less resistive than 4 Ω (typ) is not advisable. Below 4 Ω (typ) the thermal performance of the device dramatically reduces because of increased output current and reduced amplifier efficiency. The Absolute Maximum rating of 3.2 Ω covers the manufacturing tolerance of a 4 Ω speaker and speaker impedance decrease due to frequency. θ_{JA} is a gross approximation of the complex thermal transfer mechanisms between the device and its ambient environment. If the θ_{JA} calculation reveals a potential problem, a more accurate estimate should be made.

WHEN TO USE AN OUTPUT FILTER

Design the TPA2038D1 without an Inductor / Capacitor (LC) output filter if the traces from the amplifier to the speaker are short. Wireless handsets and PDAs are great applications for this class-D amplifier to be used without an output filter.

The TPA2038D1 does not require an LC output filter for short speaker connections (approximately 100 mm long or less). A ferrite bead can often be used in the design if failing radiated emissions testing without an LC filter; and, the frequency-sensitive circuit is greater than 1 MHz. If choosing a ferrite bead, choose one with high impedance at high frequencies, but very low impedance at low frequencies. The selection must also take into account the currents flowing through the ferrite bead. Ferrites can begin to lose effectiveness at much lower than rated current values. See the EVM User's Guide ([SLOU298](#)) for components used successfully by TI.

Figure 45 shows a typical ferrite-bead output filter.

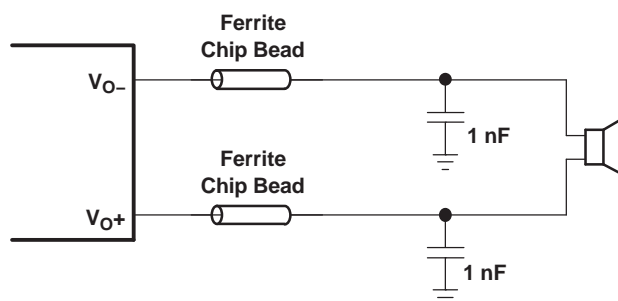

Figure 45. Typical Ferrite Chip Bead Filter

PRINTED CIRCUIT BOARD LAYOUT

In making the pad size for the WCSP balls, it is recommended that the layout use non-solder-mask-defined (NSMD) land. With this method, the solder mask opening is made larger than the desired land area, and the opening size is defined by the copper pad width. [Figure 46](#) shows the appropriate diameters for a WCSP layout.

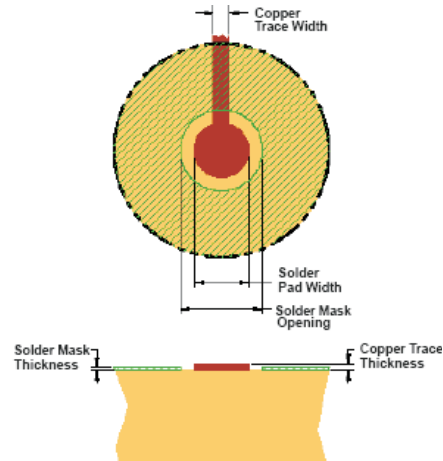

Figure 46. Land Pattern Image and Dimensions

SOLDER PAD DEFINITIONS	COPPER PAD	SOLDER MASK OPENING ⁽⁵⁾	COPPER THICKNESS	STENCIL OPENING ⁽⁶⁾⁽⁷⁾	STENCIL THICKNESS
Non-solder-mask-defined (NSMD)	0.23 mm	0.310 mm	1 oz max (0.032 mm)	0.275 mm x 0.275 mm Sq. (rounded corners)	0.1 mm thick

1. Circuit traces from NSMD defined PWB lands should be 75 μm to 100 μm wide in the exposed area inside the solder mask opening. Wider trace widths reduce device stand off and impact reliability.
2. Best reliability results are achieved when the PWB laminate glass transition temperature is above the operating range of the intended application.
3. Recommend solder paste is Type 3 or Type 4.
4. For a PWB using a Ni/Au surface finish, the gold thickness should be less 0.5 μm to avoid a reduction in thermal fatigue performance.
5. Solder mask thickness should be less than 20 μm on top of the copper circuit pattern
6. Best solder stencil performance is achieved using laser cut stencils with electro polishing. Use of chemically etched stencils give inferior solder paste volume control.
7. Trace routing away from WCSP device should be balanced in X and Y directions to avoid unintentional component movement due to solder wetting forces.

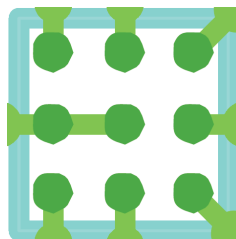

Figure 47. Layout Snapshot

An on-pad via is not required to route the middle ball B2 (PV_{DD}) of the TPA2038D1. Short ball B2 (PV_{DD}) to ball B1 (V_{DD}) and connect both to the supply trace as shown in [Figure 47](#). This simplifies board routing and saves manufacturing cost.

PACKAGE DIMENSIONS

D	E
Max = 1190 μ m	Max = 1244 μ m
Min = 1130 μ m	Min = 1184 μ m

REVISION HISTORY

Changes from Original (August 2011) to Revision A	Page
• Changed in first sentence of Description, 8-ohm to 4-ohm	1
• Changed D and E dimensions in the Package Dimensions table.	17

PACKAGING INFORMATION

Orderable Device	Status (1)	Package Type	Package Drawing	Pins	Package Qty	Eco Plan (2)	Lead finish/ Ball material (6)	MSL Peak Temp (3)	Op Temp (°C)	Device Marking (4/5)	Samples
TPA2038D1YFFR	ACTIVE	DSBGA	YFF	9	3000	RoHS & Green	SNAGCU	Level-1-260C-UNLIM	-40 to 85	QWK	Samples
TPA2038D1YFFT	ACTIVE	DSBGA	YFF	9	250	RoHS & Green	SNAGCU	Level-1-260C-UNLIM	-40 to 85	QWK	Samples

(1) The marketing status values are defined as follows:

ACTIVE: Product device recommended for new designs.

LIFEBUY: TI has announced that the device will be discontinued, and a lifetime-buy period is in effect.

NRND: Not recommended for new designs. Device is in production to support existing customers, but TI does not recommend using this part in a new design.

PREVIEW: Device has been announced but is not in production. Samples may or may not be available.

OBSOLETE: TI has discontinued the production of the device.

(2) **RoHS:** TI defines "RoHS" to mean semiconductor products that are compliant with the current EU RoHS requirements for all 10 RoHS substances, including the requirement that RoHS substance do not exceed 0.1% by weight in homogeneous materials. Where designed to be soldered at high temperatures, "RoHS" products are suitable for use in specified lead-free processes. TI may reference these types of products as "Pb-Free".

RoHS Exempt: TI defines "RoHS Exempt" to mean products that contain lead but are compliant with EU RoHS pursuant to a specific EU RoHS exemption.

Green: TI defines "Green" to mean the content of Chlorine (Cl) and Bromine (Br) based flame retardants meet JS709B low halogen requirements of <=1000ppm threshold. Antimony trioxide based flame retardants must also meet the <=1000ppm threshold requirement.

(3) MSL, Peak Temp. - The Moisture Sensitivity Level rating according to the JEDEC industry standard classifications, and peak solder temperature.

(4) There may be additional marking, which relates to the logo, the lot trace code information, or the environmental category on the device.

(5) Multiple Device Markings will be inside parentheses. Only one Device Marking contained in parentheses and separated by a "~" will appear on a device. If a line is indented then it is a continuation of the previous line and the two combined represent the entire Device Marking for that device.

(6) Lead finish/Ball material - Orderable Devices may have multiple material finish options. Finish options are separated by a vertical ruled line. Lead finish/Ball material values may wrap to two lines if the finish value exceeds the maximum column width.

Important Information and Disclaimer:The information provided on this page represents TI's knowledge and belief as of the date that it is provided. TI bases its knowledge and belief on information provided by third parties, and makes no representation or warranty as to the accuracy of such information. Efforts are underway to better integrate information from third parties. TI has taken and continues to take reasonable steps to provide representative and accurate information but may not have conducted destructive testing or chemical analysis on incoming materials and chemicals. TI and TI suppliers consider certain information to be proprietary, and thus CAS numbers and other limited information may not be available for release.

In no event shall TI's liability arising out of such information exceed the total purchase price of the TI part(s) at issue in this document sold by TI to Customer on an annual basis.

TAPE AND REEL INFORMATION

QUADRANT ASSIGNMENTS FOR PIN 1 ORIENTATION IN TAPE

*All dimensions are nominal

Device	Package Type	Package Drawing	Pins	SPQ	Reel Diameter (mm)	Reel Width W1 (mm)	A0 (mm)	B0 (mm)	K0 (mm)	P1 (mm)	W (mm)	Pin1 Quadrant
TPA2038D1YFFR	DSBGA	YFF	9	3000	180.0	8.4	1.34	1.34	0.81	4.0	8.0	Q1
TPA2038D1YFFT	DSBGA	YFF	9	250	180.0	8.4	1.34	1.34	0.81	4.0	8.0	Q1

TAPE AND REEL BOX DIMENSIONS

*All dimensions are nominal

Device	Package Type	Package Drawing	Pins	SPQ	Length (mm)	Width (mm)	Height (mm)
TPA2038D1YFFR	DSBGA	YFF	9	3000	182.0	182.0	20.0
TPA2038D1YFFT	DSBGA	YFF	9	250	182.0	182.0	20.0

YFF0009

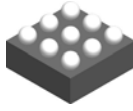

PACKAGE OUTLINE

DSBGA - 0.625 mm max height

DIE SIZE BALL GRID ARRAY

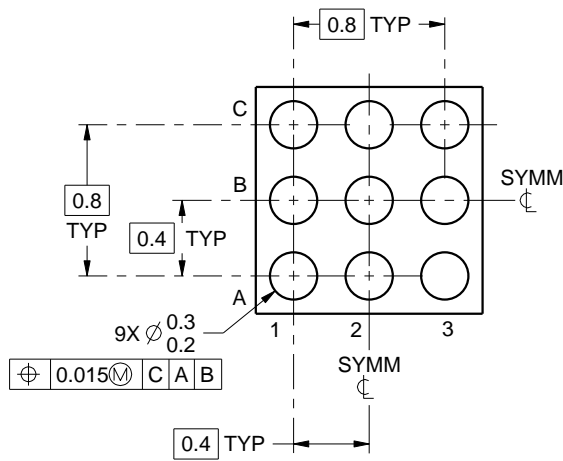
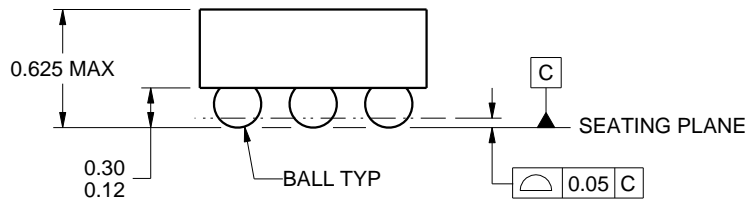
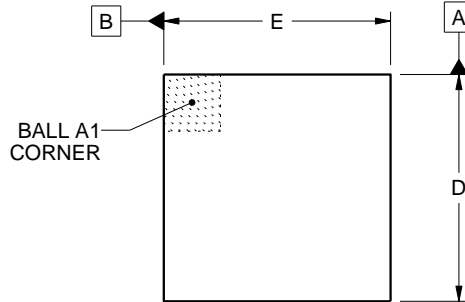

D: Max = 1.244 mm, Min = 1.184 mm
E: Max = 1.19 mm, Min = 1.13 mm

4219552/A 05/2016

NOTES:

1. All linear dimensions are in millimeters. Any dimensions in parenthesis are for reference only. Dimensioning and tolerancing per ASME Y14.5M.
2. This drawing is subject to change without notice.

EXAMPLE BOARD LAYOUT

YFF0009

DSBGA - 0.625 mm max height

DIE SIZE BALL GRID ARRAY

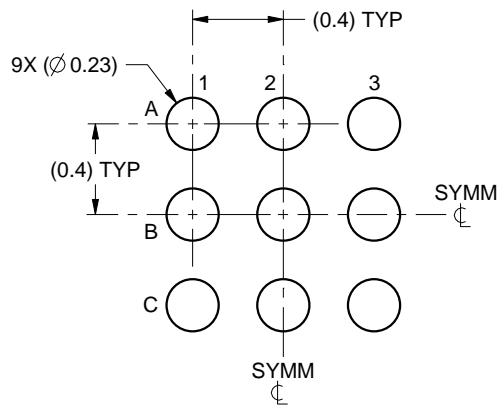

LAND PATTERN EXAMPLE
SCALE:30X



SOLDER MASK DETAILS
NOT TO SCALE

4219552/A 05/2016

NOTES: (continued)

3. Final dimensions may vary due to manufacturing tolerance considerations and also routing constraints. For more information, see Texas Instruments literature number SNVA009 (www.ti.com/lit/snva009).

EXAMPLE STENCIL DESIGN

YFF0009

DSBGA - 0.625 mm max height

DIE SIZE BALL GRID ARRAY

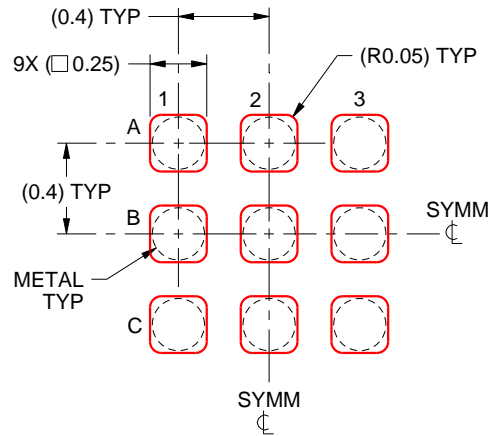

SOLDER PASTE EXAMPLE
BASED ON 0.1 mm THICK STENCIL
SCALE:30X

4219552/A 05/2016

NOTES: (continued)

4. Laser cutting apertures with trapezoidal walls and rounded corners may offer better paste release.

IMPORTANT NOTICE AND DISCLAIMER

TI PROVIDES TECHNICAL AND RELIABILITY DATA (INCLUDING DATA SHEETS), DESIGN RESOURCES (INCLUDING REFERENCE DESIGNS), APPLICATION OR OTHER DESIGN ADVICE, WEB TOOLS, SAFETY INFORMATION, AND OTHER RESOURCES "AS IS" AND WITH ALL FAULTS, AND DISCLAIMS ALL WARRANTIES, EXPRESS AND IMPLIED, INCLUDING WITHOUT LIMITATION ANY IMPLIED WARRANTIES OF MERCHANTABILITY, FITNESS FOR A PARTICULAR PURPOSE OR NON-INFRINGEMENT OF THIRD PARTY INTELLECTUAL PROPERTY RIGHTS.

These resources are intended for skilled developers designing with TI products. You are solely responsible for (1) selecting the appropriate TI products for your application, (2) designing, validating and testing your application, and (3) ensuring your application meets applicable standards, and any other safety, security, regulatory or other requirements.

These resources are subject to change without notice. TI grants you permission to use these resources only for development of an application that uses the TI products described in the resource. Other reproduction and display of these resources is prohibited. No license is granted to any other TI intellectual property right or to any third party intellectual property right. TI disclaims responsibility for, and you will fully indemnify TI and its representatives against, any claims, damages, costs, losses, and liabilities arising out of your use of these resources.

TI's products are provided subject to [TI's Terms of Sale](#) or other applicable terms available either on [ti.com](https://www.ti.com) or provided in conjunction with such TI products. TI's provision of these resources does not expand or otherwise alter TI's applicable warranties or warranty disclaimers for TI products.

TI objects to and rejects any additional or different terms you may have proposed.

Mailing Address: Texas Instruments, Post Office Box 655303, Dallas, Texas 75265
Copyright © 2023, Texas Instruments Incorporated