

## TPS25925x, TPS25926x Simple 5-V/12-V eFuse Protection Switches

### 1 Features

- 12-V eFuse – TPS25926x
- 5-V eFuse – TPS25925x
- Integrated 30-mΩ Pass MOSFET
- Fixed Over-Voltage Clamp:
  - 6.1-V Clamp - TPS25925x
  - 15-V Clamp - TPS25926x
- 2-A to 5-A Adjustable  $I_{LIMIT}$  ( $\pm 15\%$  Accuracy)
- Programmable  $V_{OUT}$  Slew Rate, UVLO
- Built-in Thermal Shutdown
- UL 2367 Recognized – File No. E339631\*
  - $*R_{ILIM} \leq 130 \text{ k}\Omega$  (5 A maximum)
- Safe During Single Point Failure Test (UL60950)
- Small Foot Print – 10L (3 mm x 3 mm) VSON

### 2 Applications

- HDD and SSD Drives
- Set Top Boxes
- Servers and AUX Supplies
- PCI and PCIe Cards
- Adapter Powered Devices

### 3 Description

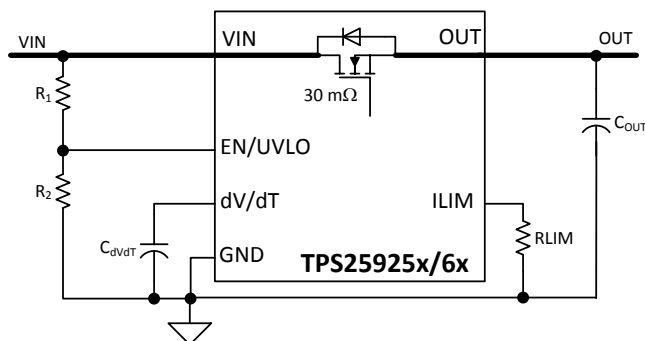
The TPS25925x/6x family of eFuses is a highly integrated circuit protection and power management solution in a tiny package. The devices use few external components and provide multiple protection modes. They are a robust defense against overloads, shorts circuits, voltage surges, excessive inrush current. Current limit level can be set with a single external resistor and current limit set has a typical accuracy of  $\pm 15\%$ . Over voltage events are limited by internal clamping circuits to a safe fixed maximum, with no external components required. TPS25926x devices provide over voltage protection (OVP) for 12-V systems and TPS25925x devices for 5-V systems. In cases with particular voltage ramp requirements, a dV/dT pin is provided that can be programmed with a single capacitor to ensure proper output ramp rates.

#### Device Information<sup>(1)</sup>

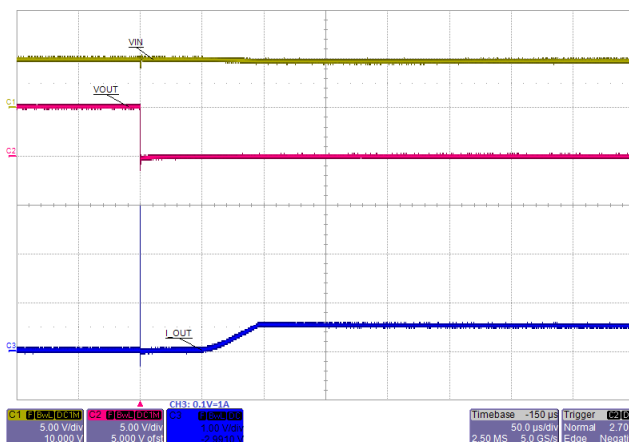
PART NUMBER	PACKAGE	BODY SIZE (NOM)
TPS259250, TPS259251	VSON (10)	3.00 mm x 3.00 mm
TPS259260, TPS259261		

(1) For all available packages, see the orderable addendum at the end of the data sheet.

#### Application Schematic



#### Transient: Output Short Circuit



## Table of Contents

<b>1</b>	<b>Features</b> .....	<b>1</b>	<b>9</b>	<b>Application and Implementation</b> .....	<b>18</b>
<b>2</b>	<b>Applications</b> .....	<b>1</b>	9.1	Application Information.....	18
<b>3</b>	<b>Description</b> .....	<b>1</b>	9.2	Typical Application .....	18
<b>4</b>	<b>Revision History</b> .....	<b>2</b>	<b>10</b>	<b>Power Supply Recommendations</b> .....	<b>23</b>
<b>5</b>	<b>Device Comparison Table</b> .....	<b>3</b>	10.1	Transient Protection .....	23
<b>6</b>	<b>Pin Configuration and Functions</b> .....	<b>3</b>	10.2	Output Short-Circuit Measurements .....	24
<b>7</b>	<b>Specifications</b> .....	<b>4</b>	<b>11</b>	<b>Layout</b> .....	<b>24</b>
7.1	Absolute Maximum Ratings .....	4	11.1	Layout Guidelines .....	24
7.2	ESD Ratings .....	4	11.2	Layout Example .....	25
7.3	Recommended Operating Conditions.....	4	<b>12</b>	<b>Device and Documentation Support</b> .....	<b>26</b>
7.4	Thermal Information .....	5	12.1	Device Support .....	26
7.5	Electrical Characteristics.....	5	12.2	Documentation Support .....	26
7.6	Timing Requirements .....	6	12.3	Related Links .....	26
7.7	Typical Characteristics.....	7	12.4	Receiving Notification of Documentation Updates	26
<b>8</b>	<b>Detailed Description</b> .....	<b>14</b>	12.5	Community Resources.....	26
8.1	Overview .....	14	12.6	Trademarks .....	26
8.2	Functional Block Diagram .....	14	12.7	Electrostatic Discharge Caution.....	26
8.3	Feature Description.....	14	12.8	Glossary .....	27
8.4	Device Functional Modes.....	17	<b>13</b>	<b>Mechanical, Packaging, and Orderable Information</b> .....	<b>27</b>

## 4 Revision History

Changes from Revision A (August 2015) to Revision B	Page
• Updated <a href="#">Features</a> , <a href="#">Description</a> , <a href="#">Feature Description</a> and <a href="#">Device Functional Modes</a> section .....	1

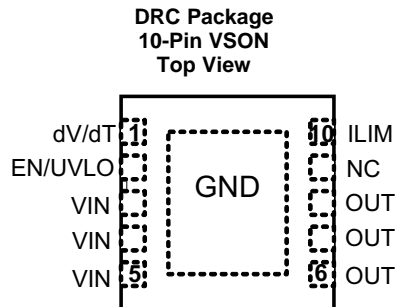
  

Changes from Original (August 2015) to Revision A	Page
• Changed from Product Preview to Production Data.....	1

## 5 Device Comparison Table

PART NUMBER	UV	OV CLAMP	FAULT RESPONSE	STATUS
TPS259250	4.3 V	6.1 V	Latched	Active
TPS259251	4.3 V	6.1 V	Auto Retry	Active
TPS259260	4.3 V	15 V	Latched	Active
TPS259261	4.3 V	15 V	Auto Retry	Active

## 6 Pin Configuration and Functions



### Pin Functions

PIN		TYPE	DESCRIPTION
No.	NAME		
1	dV/dT	O	Connect a capacitor from this pin to GND to control the ramp rate of OUT voltage at device turnon
2	EN/UVLO	I	This is a dual function control pin. When used as an ENABLE pin and pulled down, it shuts off the internal pass MOSFET. When pulled high, it enables the device As an UVLO pin, it can be used to program different UVLO trip point via external resistor divider
3	VIN	I	Input supply voltage
4			
5			
6	OUT	O	Output of the device
7			
8			
9	NC	NC	Not Connected Internally. Can be left floating or grounded
10	ILIM	O	A resistor from this pin to GND sets the overload and short circuit limit
Thermal Pad	GND	Ground	GND

## 7 Specifications

### 7.1 Absolute Maximum Ratings

 over operating temperature range (unless otherwise noted) <sup>(1)</sup> <sup>(2)</sup>

		MIN	MAX	UNIT
Supply voltage <sup>(2)</sup>	VIN	-0.3	20	V
	VIN (transient < 1 ms)		22	
Output voltage	OUT	-0.3	VIN + 0.3	V
	OUT (transient < 1 μs)		-1.2	
Voltage	ILIM	-0.3	7	V
Continuous output current			6.25 <sup>(3)</sup>	A
Voltage	EN/UVLO	-0.3	7	V
Voltage	dV/dT	-0.3	7	V
Storage temperature	T <sub>stg</sub>	-65	150	°C

- (1) Stresses beyond those listed under *Absolute Maximum Ratings* may cause permanent damage to the device. These are stress ratings only, which do not imply functional operation of the device at these or any other conditions beyond those indicated under *Recommended Operating Conditions*. Exposure to absolute-maximum-rated conditions for extended periods may affect device reliability.
- (2) All voltage values, except differential voltages, are with respect to network ground terminal.
- (3) Device supports high peak current during short circuit conditions until current is internally limited.

### 7.2 ESD Ratings

			VALUE	UNIT
V <sub>(ESD)</sub>	Electrostatic discharge	Human body model (HBM), per ANSI/ESDA/JEDEC JS-001 <sup>(1)</sup>	±2000	V
		Charged device model (CDM), per JEDEC specification JESD22-C101 <sup>(2)</sup>	±500	

- (1) JEDEC document JEP155 states that 500-V HBM allows safe manufacturing with a standard ESD control process.
- (2) JEDEC document JEP157 states that 250-V CDM allows safe manufacturing with a standard ESD control process.

### 7.3 Recommended Operating Conditions

over operating free-air temperature range (unless otherwise noted)

		MIN	TYP	MAX	UNIT
Input voltage	VIN (TPS25926x)	4.5	12	13.8	V
	VIN (TPS25925x)	4.5	5	5.5	
	dV/dT, EN/UVLO	0		6	
	ILIM	0		3	
Continuous output current	I <sub>OUT</sub>	0		5	A
Resistance	ILIM	10	100	162	kΩ
External capacitance	OUT	0.1	1	1000	μF
	dV/dT		1	1000	nF
Operating junction temperature	T <sub>J</sub>	-40	25	125	°C
Operating ambient temperature	T <sub>A</sub>	-40	25	85	°C

## 7.4 Thermal Information<sup>(1)</sup>

over operating free-air temperature range (unless otherwise noted)

THERMAL METRIC		TPS25925x/6x	UNIT
		DRC (VSON)	
		10 PINS	
R <sub>θJA</sub>	Junction-to-ambient thermal resistance	45.9	°C/W
R <sub>θJctop</sub>	Junction-to-case (top) thermal resistance	53	°C/W
R <sub>θJB</sub>	Junction-to-board thermal resistance	21.2	°C/W
Ψ <sub>JT</sub>	Junction-to-top characterization parameter	1.2	°C/W
Ψ <sub>JB</sub>	Junction-to-board characterization parameter	21.4	°C/W
R <sub>θJcbot</sub>	Junction-to-case (bottom) thermal resistance	5.9	°C/W

(1) For more information about traditional and new thermal metrics, see the *Semiconductor and IC Package Thermal Metrics* application report, [SPRA953](#).

## 7.5 Electrical Characteristics

–40°C ≤ T<sub>J</sub> ≤ +125°C, V<sub>IN</sub> = 12 V for TPS25926x, V<sub>IN</sub> = 5 V for TPS25925x, V<sub>EN /UVLO</sub> = 2 V, R<sub>ILIM</sub> = 100 kΩ, C<sub>dVdT</sub> = OPEN. All voltages referenced to GND (unless otherwise noted).

PARAMETER		TEST CONDITIONS	MIN	TYP	MAX	UNIT
<b>VIN (INPUT SUPPLY)</b>						
V <sub>UVR</sub>	UVLO threshold, rising		4.15	4.3	4.45	V
V <sub>UVhyst</sub>	UVLO hysteresis <sup>(1)</sup>			5%		
I <sub>QON</sub>	Supply current	Enabled: EN/UVLO = 2 V, TPS25926x	0.3	0.47	0.55	mA
I <sub>QOFF</sub>		Enabled: EN/UVLO = 2 V, TPS25925x	0.35	0.42	0.6	mA
		EN/UVLO = 0 V		0.13	0.225	mA
V <sub>OV</sub>	Over-voltage clamp	V <sub>IN</sub> > 16.5 V, I <sub>OUT</sub> = 10 mA, TPS25926x	13.8	15	16.5	V
		V <sub>IN</sub> > 6.75 V, I <sub>OUT</sub> = 10 mA, –40°C ≤ T <sub>J</sub> ≤ +85°C, TPS25925x	5.5	6.1	6.75	
		V <sub>IN</sub> > 6.75 V, I <sub>OUT</sub> = 10 mA, –40°C ≤ T <sub>J</sub> ≤ +125°C, TPS25925x	5.25	6.1	6.75	
<b>EN/UVLO (ENABLE/UVLO INPUT)</b>						
V <sub>ENR</sub>	EN threshold voltage, rising		1.37	1.4	1.44	V
V <sub>ENF</sub>	EN threshold voltage, falling		1.32	1.35	1.39	V
I <sub>EN</sub>	EN input leakage current	0 V ≤ V <sub>EN</sub> ≤ 5 V	–100	0	100	nA
<b>dV/dT (OUTPUT RAMP CONTROL)</b>						
I <sub>dVdT</sub>	dV/dT charging current <sup>(1)</sup>	V <sub>dVdT</sub> = 0 V		220		nA
R <sub>dVdT_disch</sub>	dV/dT discharging resistance	EN/UVLO = 0 V, I <sub>dVdT</sub> = 10 mA sinking	50	73	100	Ω
V <sub>dVdTmax</sub>	dV/dT maximum capacitor voltage <sup>(1)</sup>			5.5		V
GAIN <sub>dVdT</sub>	dV/dT to OUT gain <sup>(1)</sup>	ΔV <sub>dVdT</sub>		4.85		V/V
<b>ILIM (CURRENT LIMIT PROGRAMMING)</b>						
I <sub>ILIM</sub>	ILIM bias current <sup>(1)</sup>			10		μA
I <sub>OL</sub>	Overload current limit <sup>(2)</sup>	R <sub>ILIM</sub> = 45.3 kΩ, V <sub>VIN-OUT</sub> = 1 V	1.75	2.1	2.45	A
		R <sub>ILIM</sub> = 100 kΩ, V <sub>VIN-OUT</sub> = 1 V	3.4	3.75	4.05	
		R <sub>ILIM</sub> = 150 kΩ, V <sub>VIN-OUT</sub> = 1 V	4.5	5.1	5.7	
I <sub>OL-R-Short</sub>		R <sub>ILIM</sub> = 0 Ω, shorted resistor current limit (single point failure test: UL60950) <sup>(1)</sup>		0.84		A
I <sub>OL-R-Open</sub>		R <sub>ILIM</sub> = OPEN, open resistor current limit (single point failure test: UL60950) <sup>(1)</sup>		0.73		A

(1) These parameters are provided for reference only and do not constitute part of TI's published device specifications for purposes of TI's product warranty.

(2) Pulsed testing techniques used during this test maintain junction temperature approximately equal to ambient temperature.

## Electrical Characteristics (continued)

–40°C ≤ T<sub>J</sub> ≤ +125°C, V<sub>IN</sub> = 12 V for TPS25926x, V<sub>IN</sub> = 5 V for TPS25925x, V<sub>EN /UVLO</sub> = 2 V, R<sub>ILIM</sub> = 100 kΩ, C<sub>dVdT</sub> = OPEN. All voltages referenced to GND (unless otherwise noted).

PARAMETER		TEST CONDITIONS	MIN	TYP	MAX	UNIT
I <sub>SCL</sub>	Short-circuit current limit <sup>(2)</sup>	R <sub>ILIM</sub> = 45.3 kΩ, V <sub>VIN-OUT</sub> = 5 V, TPS25925x	1.72	2.05	2.42	A
		R <sub>ILIM</sub> = 45.3 kΩ, V <sub>VIN-OUT</sub> = 12 V, TPS25926x	1.62	1.98	2.37	
		R <sub>ILIM</sub> = 100 kΩ, V <sub>VIN-OUT</sub> = 5 V, TPS25925x	3.1	3.56	4	
		R <sub>ILIM</sub> = 100 kΩ, V <sub>VIN-OUT</sub> = 12 V, TPS25926x	2.9	3.32	3.85	
		R <sub>ILIM</sub> = 150 kΩ, V <sub>VIN-OUT</sub> = 5 V, TPS25925x	4.22	4.95	5.69	
		R <sub>ILIM</sub> = 150 kΩ, V <sub>VIN-OUT</sub> = 12 V, TPS25926x	3.7	4.5	5.5	
RATIO <sub>FASTRIP</sub>	Fast-trip comparator level w.r.t. overload current limit <sup>(1)</sup>	I <sub>FASTRIP</sub> : I <sub>OL</sub>		160%		
V <sub>OpenILIM</sub>	ILIM open resistor detect threshold <sup>(1)</sup>	V <sub>ILIM</sub> Rising, R <sub>ILIM</sub> = OPEN		3.1		V
<b>OUT (PASS FET OUTPUT)</b>						
T <sub>ON</sub>	Turnon delay <sup>(1)</sup>	EN/UVLO → H to I <sub>VIN</sub> = 100 mA, 1-A resistive load at OUT		220		μs
R <sub>DS(on)</sub>	FET ON resistance	T <sub>J</sub> = 25°C	21	30	39	mΩ
		T <sub>J</sub> = 125°C		40	50	
I <sub>OUT-OFF-LKG</sub>	OUT bias current in off state	V <sub>EN/UVLO</sub> = 0 V, V <sub>OUT</sub> = 0 V (sourcing)	–5	0	1.2	μA
I <sub>OUT-OFF-SINK</sub>		V <sub>EN/UVLO</sub> = 0V, V <sub>OUT</sub> = 300 mV (sinking)	10	15	20	
<b>THERMAL SHUT DOWN (TSD)</b>						
T <sub>SHDN</sub>	TSD threshold, rising <sup>(1)</sup>			150		°C
T <sub>SHDNhyst</sub>	TSD hysteresis <sup>(1)</sup>			10		°C
	Thermal fault: latched or autoretry	TPS259250, TPS259260		Latched		
		TPS259251, TPS259261		Auto-retry		

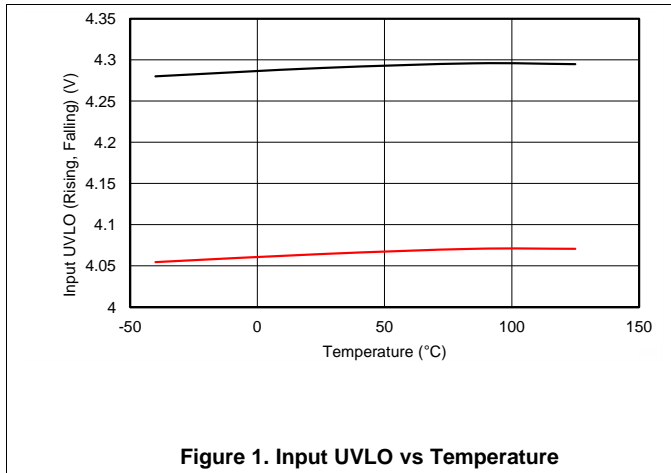
## 7.6 Timing Requirements

PARAMETER		TEST CONDITIONS	MIN	TYP	MAX	UNIT
t <sub>OFFdly</sub>	Turnoff delay <sup>(1)</sup>	EN↓		0.4		μs
<b>dV/dT (OUTPUT RAMP CONTROL)</b>						
t <sub>dVdT</sub>	Output ramp time	TPS25926x, EN/UVLO → H to OUT = 11.7 V, C <sub>dVdT</sub> = 0	0.7	1	1.3	ms
		TPS25925x, EN/UVLO → H to OUT = 4.9 V, C <sub>dVdT</sub> = 0	0.28	0.4	0.52	
		TPS25926x, EN/UVLO → H to OUT = 11.7 V, C <sub>dVdT</sub> = 1 nF <sup>(1)</sup>		12		
		TPS25925x, EN/UVLO → H to OUT = 4.9 V, C <sub>dVdT</sub> = 1 nF <sup>(1)</sup>		5		
<b>ILIM (CURRENT LIMIT PROGRAMMING)</b>						
t <sub>FastOffDly</sub>	Fast-trip comparator delay <sup>(1)</sup>	I <sub>OUT</sub> > I <sub>FASTRIP</sub> to I <sub>OUT</sub> = 0 (Switch off)		300		ns
<b>THERMAL SHUTDOWN (TSD)</b>						
t <sub>TSDdly</sub>	Retry delay after TSD recovery, T <sub>J</sub> < [T <sub>SHDN</sub> – 10°C] <sup>(1)</sup>	At V <sub>IN</sub> = 5 V, TPS259251 and TPS259261		110		ms
		At V <sub>IN</sub> = 12 V, TPS259251 and TPS259261		145		

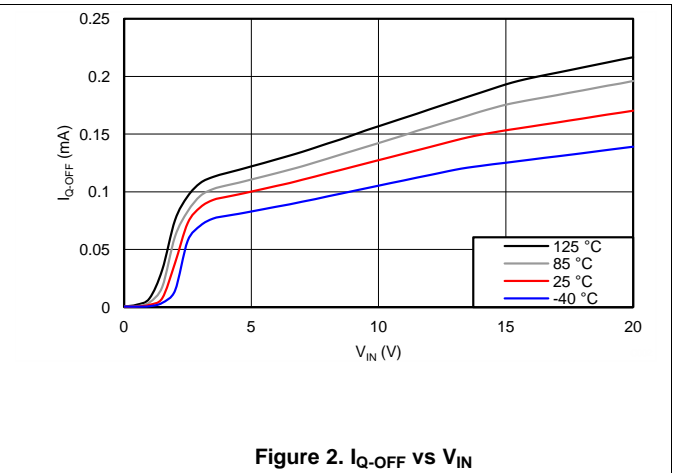
(1) These parameters are provided for reference only and do not constitute part of TI's published device specifications for purposes of TI's product warranty.

### 7.7 Typical Characteristics

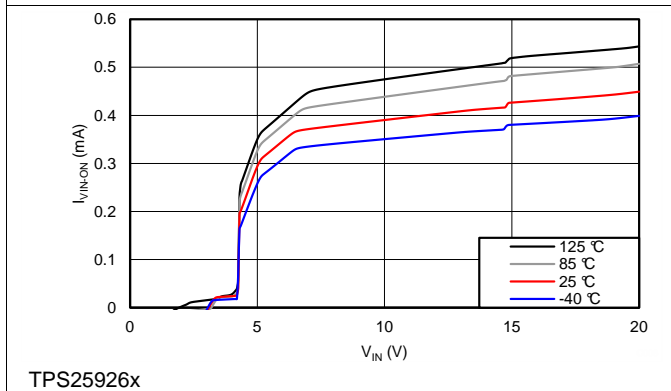
$T_J = 25^\circ\text{C}$ ,  $V_{VIN} = 12\text{ V}$  for TPS25926x,  $V_{VIN} = 5\text{ V}$  for TPS25925x,  $V_{EN/UVLO} = 2\text{ V}$ ,  $R_{ILIM} = 100\text{ k}\Omega$ ,  $C_{VIN} = 0.1\text{ }\mu\text{F}$ ,  $C_{OUT} = 1\text{ }\mu\text{F}$ ,  $C_{dVdT} = \text{OPEN}$  (unless stated otherwise)



**Figure 1. Input UVLO vs Temperature**

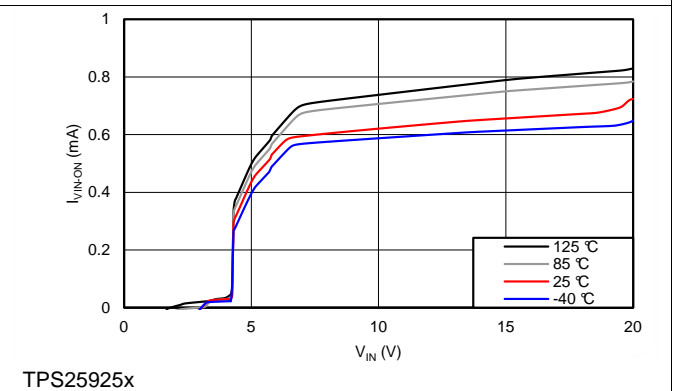


**Figure 2. IQ-OFF vs VIN**



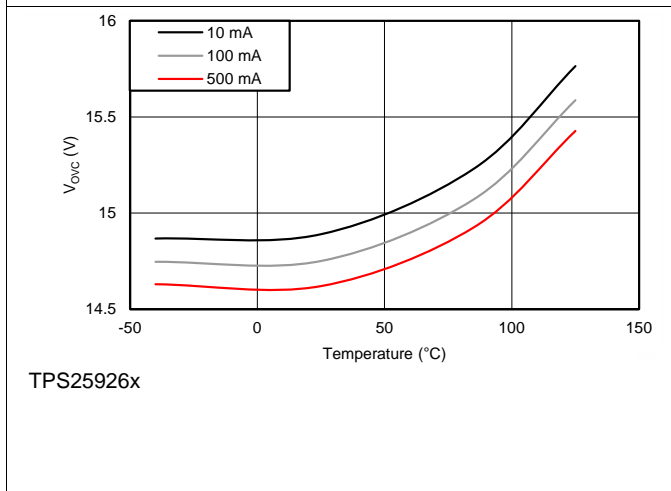
TPS25926x

**Figure 3. I\_VIN-ON vs VIN**



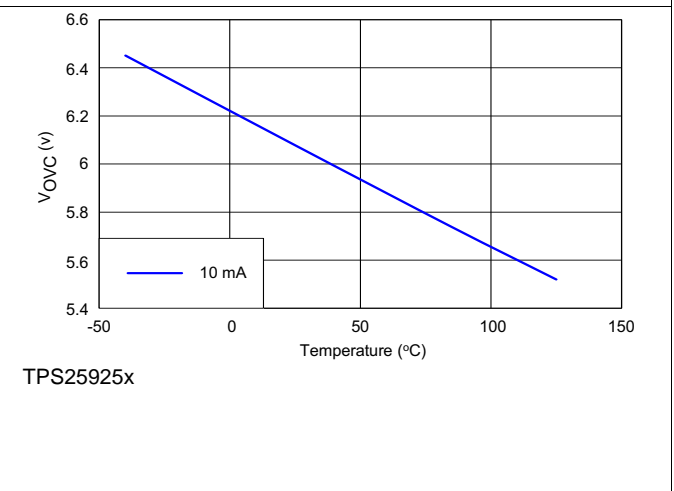
TPS25925x

**Figure 4. I\_VIN-ON vs VIN**



TPS25926x

**Figure 5. V\_OVC vs Temperature Across I\_OUT**



TPS25925x

**Figure 6. V\_OVC vs Temperature**

### Typical Characteristics (continued)

$T_J = 25^\circ\text{C}$ ,  $V_{VIN} = 12\text{ V}$  for TPS25926x,  $V_{VIN} = 5\text{ V}$  for TPS25925x,  $V_{ENUVLO} = 2\text{ V}$ ,  $R_{ILIM} = 100\text{ k}\Omega$ ,  $C_{VIN} = 0.1\text{ }\mu\text{F}$ ,  $C_{OUT} = 1\text{ }\mu\text{F}$ ,  $C_{dVdT} = \text{OPEN}$  (unless stated otherwise)

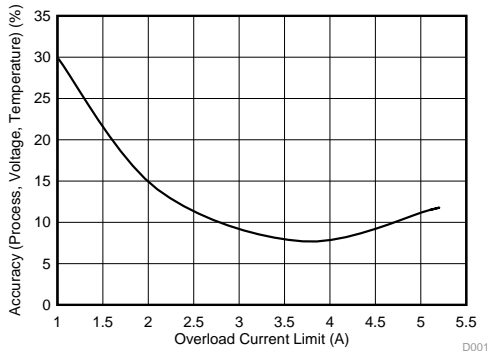


Figure 7. Accuracy vs Overload Current Limit

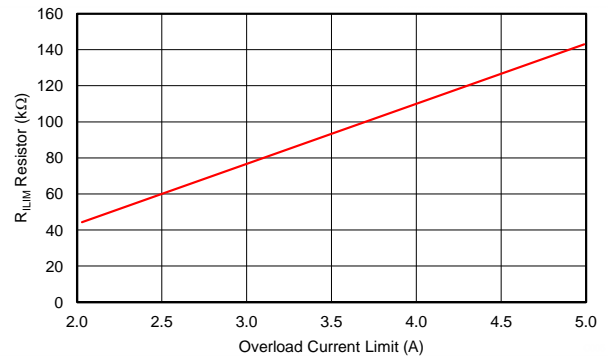
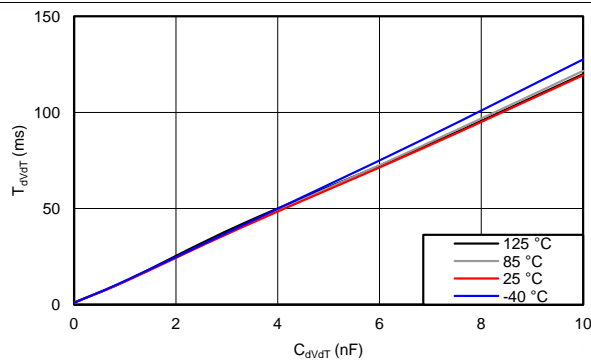
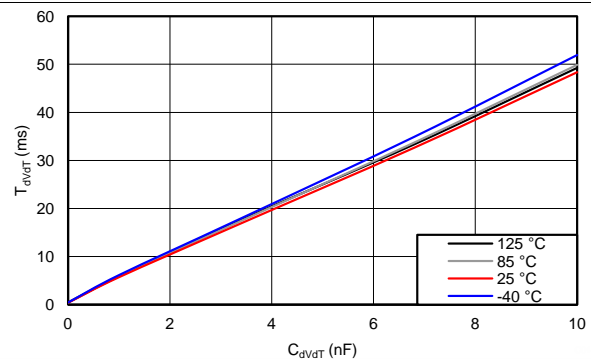


Figure 8.  $R_{ILIM}$  Resistor vs Overload Current Limit



TPS25926x

Figure 9.  $T_{dVdT}$  vs  $C_{dVdT}$



TPS25925x

Figure 10.  $T_{dVdT}$  vs  $C_{dVdT}$

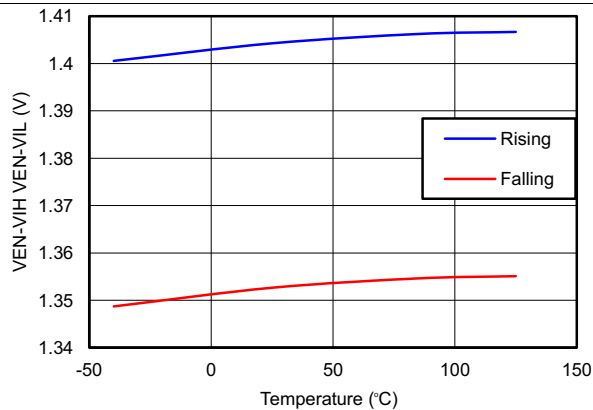


Figure 11.  $V_{EN-VIH}$ ,  $V_{EN-VIL}$  vs Temperature

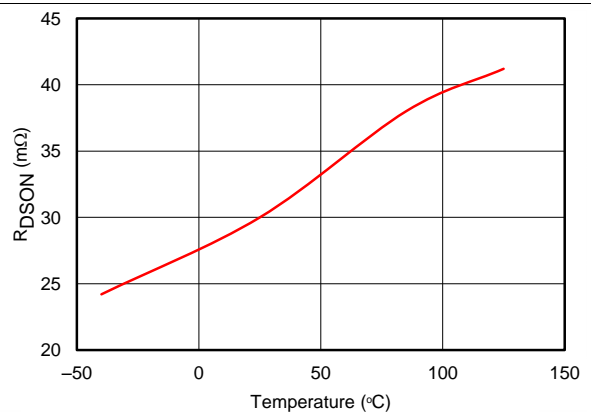


Figure 12.  $R_{DS(on)}$  vs Temperature



Typical Characteristics (continued)

$T_J = 25^\circ\text{C}$ ,  $V_{VIN} = 12\text{ V}$  for TPS25926x,  $V_{VIN} = 5\text{ V}$  for TPS25925x,  $V_{ENUVLO} = 2\text{ V}$ ,  $R_{ILIM} = 100\text{ k}\Omega$ ,  $C_{VIN} = 0.1\text{ }\mu\text{F}$ ,  $C_{OUT} = 1\text{ }\mu\text{F}$ ,  $C_{dVdT} = \text{OPEN}$  (unless stated otherwise)

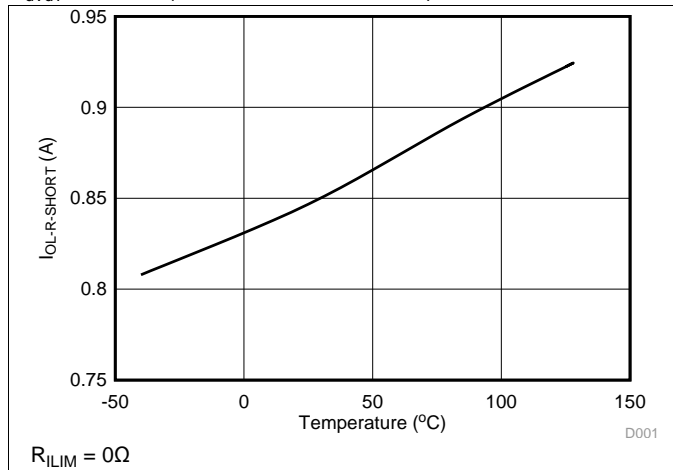


Figure 13.  $I_{OL-R-Short}$  vs Temperature

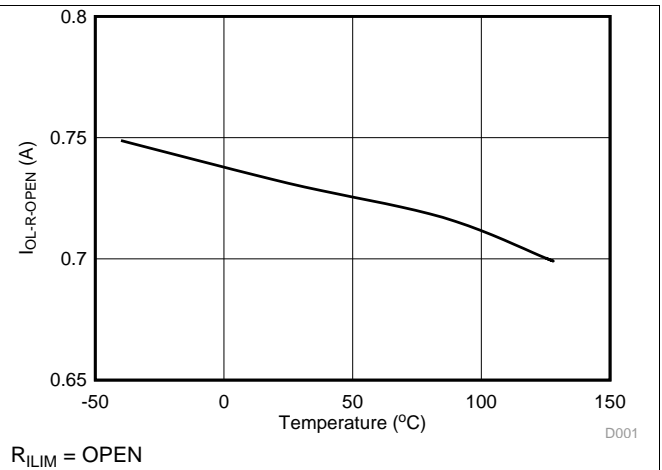


Figure 14.  $I_{OL-R-Open}$  vs Temperature

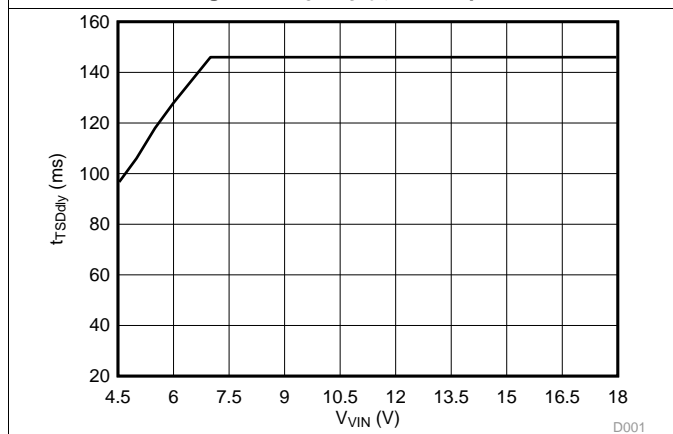


Figure 15. Retry Delay vs  $V_{VIN}$

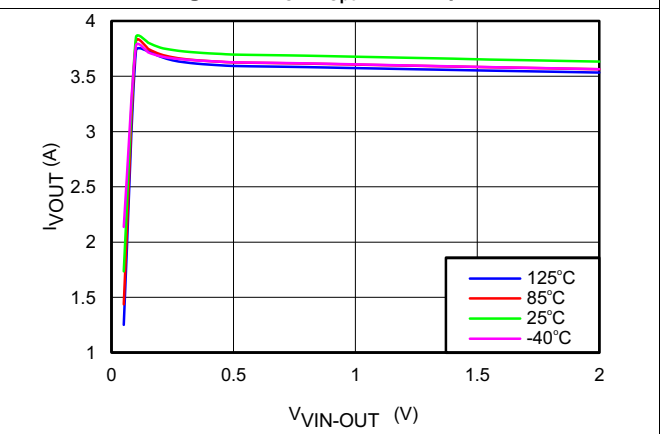


Figure 16.  $I_{VOU}$  vs  $V_{VIN-OUT}$

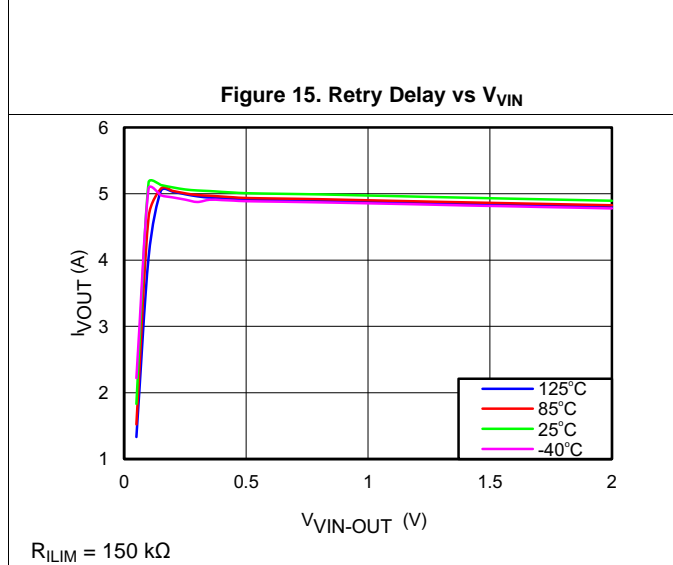


Figure 17.  $I_{VOU}$  vs  $V_{VIN-OUT}$

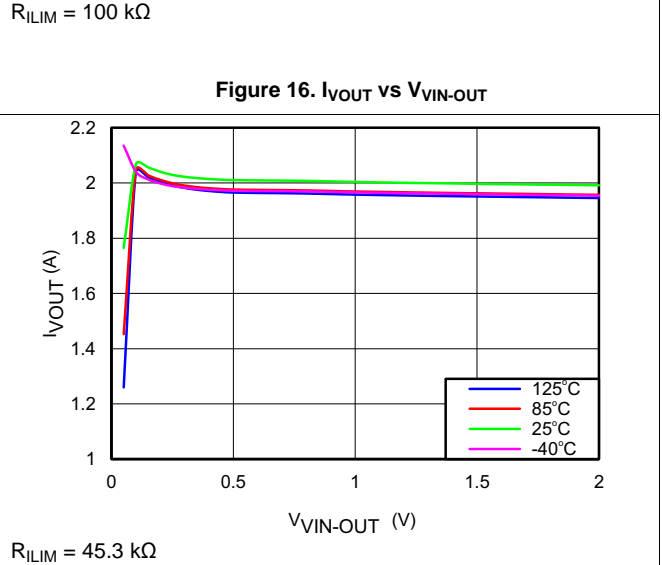
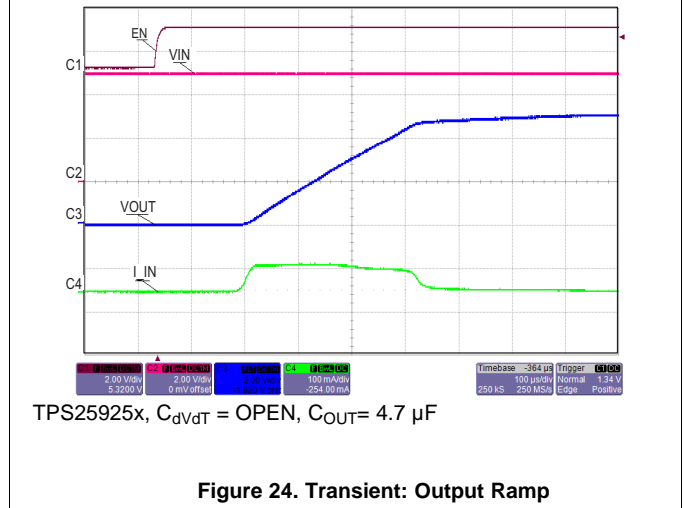
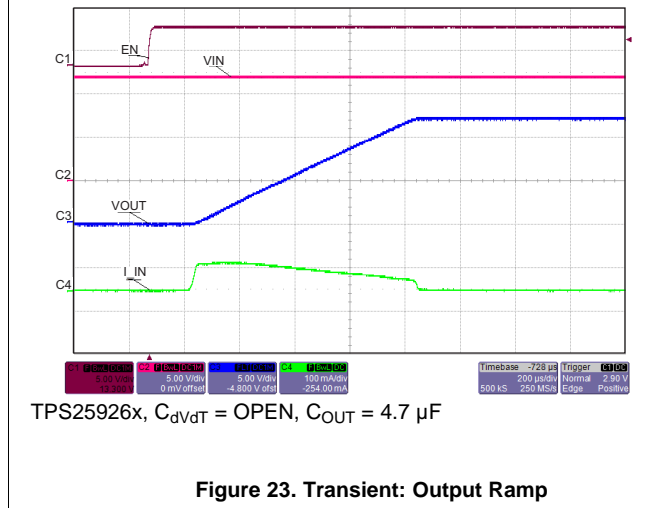
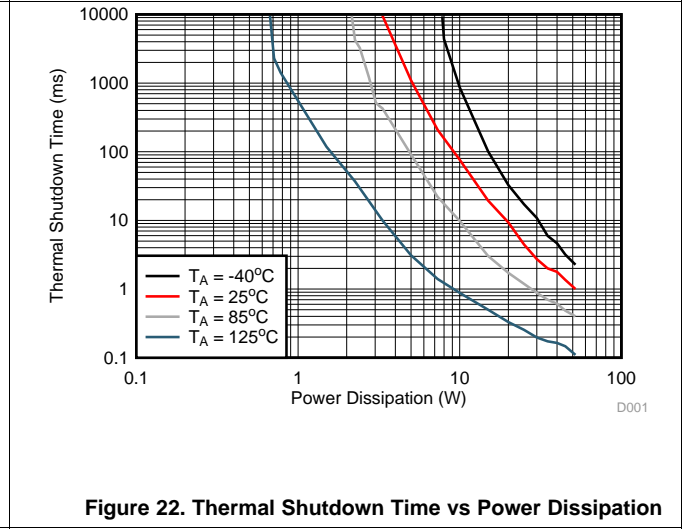
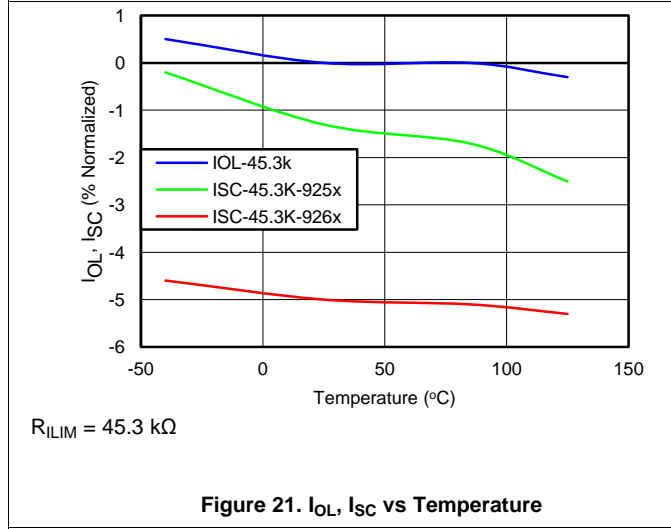
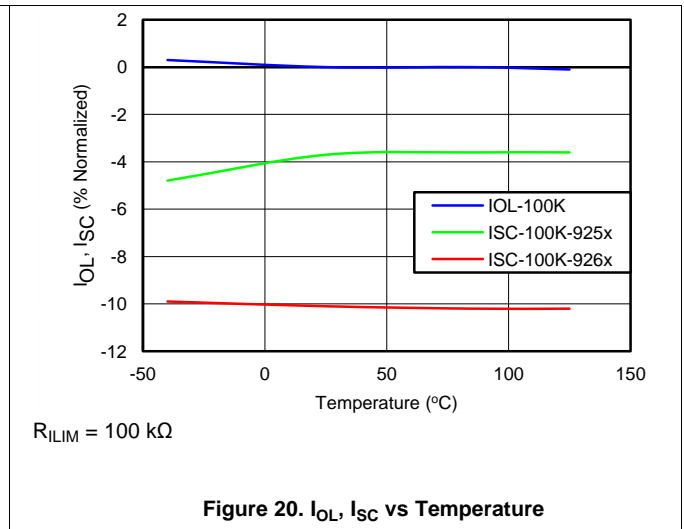
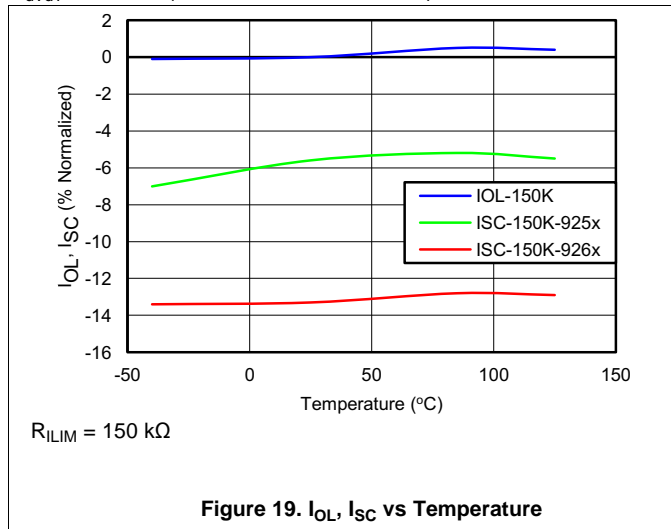


Figure 18.  $I_{VOU}$  vs  $V_{VIN-OUT}$

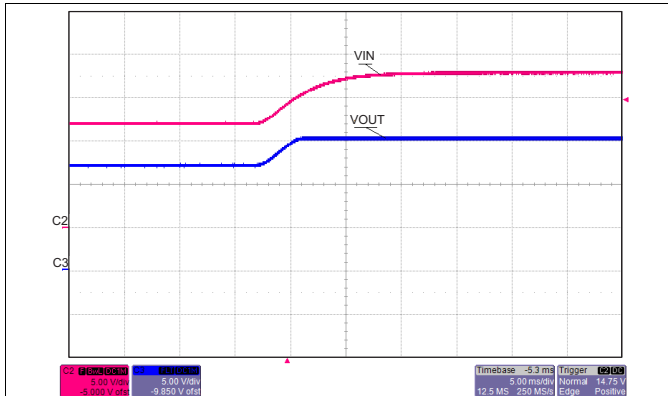
### Typical Characteristics (continued)

$T_J = 25^\circ\text{C}$ ,  $V_{VIN} = 12\text{ V}$  for TPS25926x,  $V_{VIN} = 5\text{ V}$  for TPS25925x,  $V_{ENUVLO} = 2\text{ V}$ ,  $R_{ILIM} = 100\text{ k}\Omega$ ,  $C_{VIN} = 0.1\text{ }\mu\text{F}$ ,  $C_{OUT} = 1\text{ }\mu\text{F}$ ,  $C_{dVdT} = \text{OPEN}$  (unless stated otherwise)



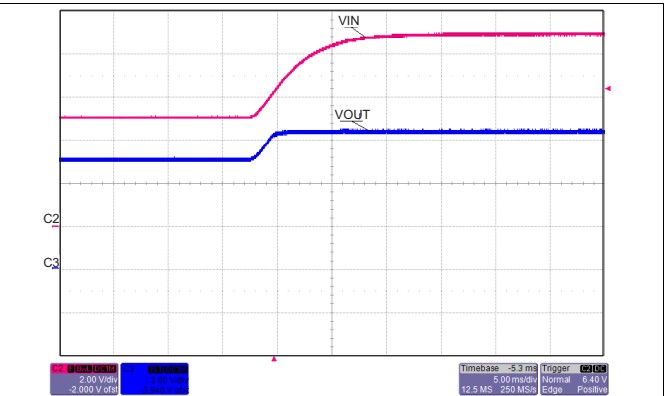
Typical Characteristics (continued)

$T_J = 25^\circ\text{C}$ ,  $V_{VIN} = 12\text{ V}$  for TPS25926x,  $V_{VIN} = 5\text{ V}$  for TPS25925x,  $V_{ENUVLO} = 2\text{ V}$ ,  $R_{ILIM} = 100\text{ k}\Omega$ ,  $C_{VIN} = 0.1\text{ }\mu\text{F}$ ,  $C_{OUT} = 1\text{ }\mu\text{F}$ ,  $C_{dVdT} = \text{OPEN}$  (unless stated otherwise)



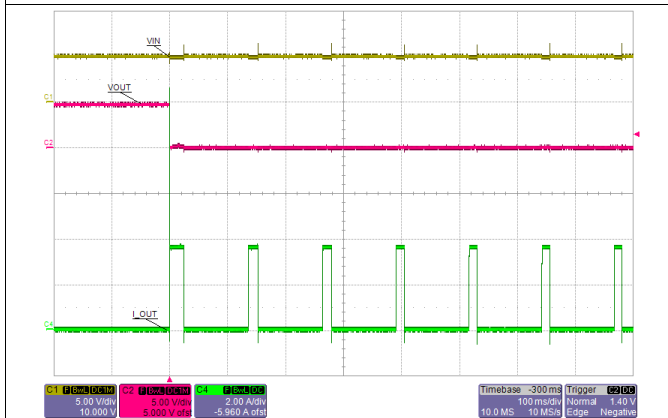
TPS25926x

Figure 25. Transient: Over-Voltage Clamp



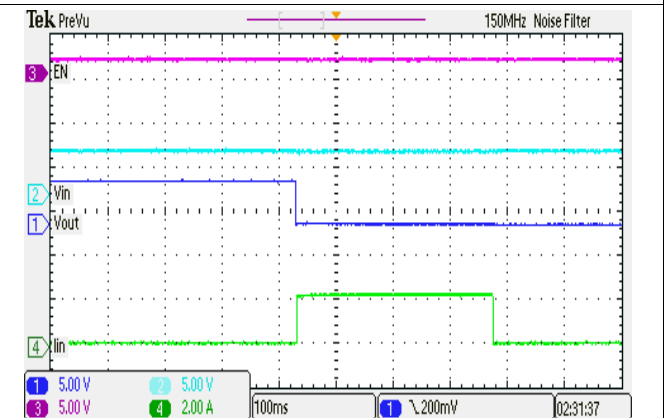
TPS25925x

Figure 26. Transient: Over-Voltage Clamp



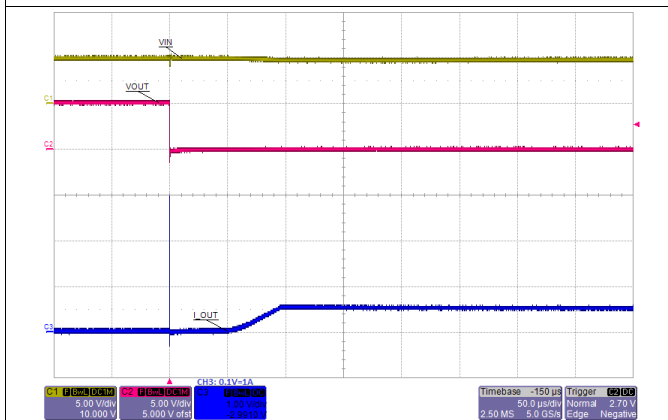
TPS259251/61,  $V_{VIN} = 5\text{ V}$

Figure 27. Transient: Thermal Fault Auto-Retry



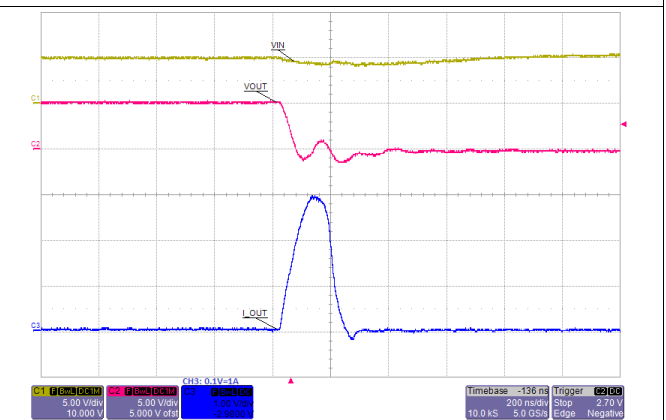
TPS259250/60,  $V_{VIN} = 5\text{ V}$

Figure 28. Transient: Thermal Fault Latched



TPS25925x/6x,  $V_{VIN} = 5\text{ V}$ ,  $R_{ILIM} = 150\text{ k}\Omega$

Figure 29. Transient: Output Short Circuit

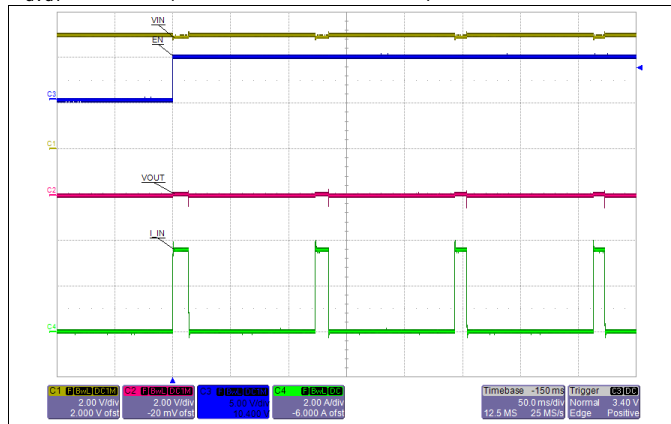


TPS25925x/6x,  $V_{VIN} = 5\text{ V}$ ,  $R_{ILIM} = 150\text{ k}\Omega$

Figure 30. Short Circuit (Zoom): Fast-Trip Comparator

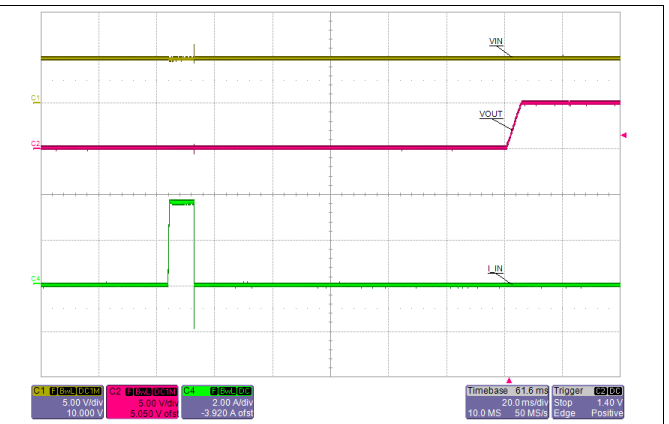
Typical Characteristics (continued)

$T_J = 25^\circ\text{C}$ ,  $V_{VIN} = 12\text{ V}$  for TPS25926x,  $V_{VIN} = 5\text{ V}$  for TPS25925x,  $V_{ENUVLO} = 2\text{ V}$ ,  $R_{ILIM} = 100\text{ k}\Omega$ ,  $C_{VIN} = 0.1\text{ }\mu\text{F}$ ,  $C_{OUT} = 1\text{ }\mu\text{F}$ ,  $C_{dVdT} = \text{OPEN}$  (unless stated otherwise)



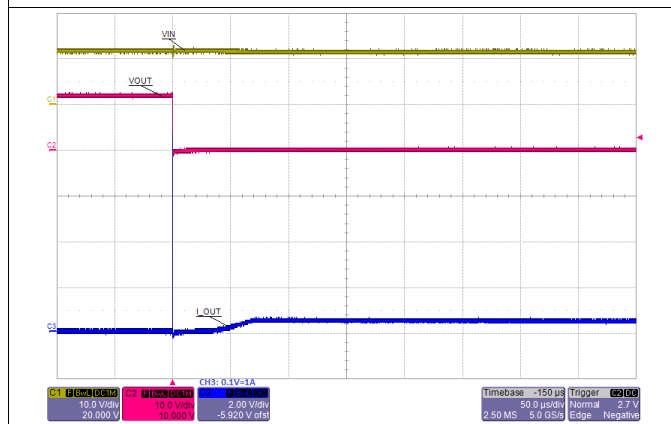
TPS259251/61,  $V_{VIN} = 5\text{ V}$

Figure 31. Transient: Wake Up to Short Circuit



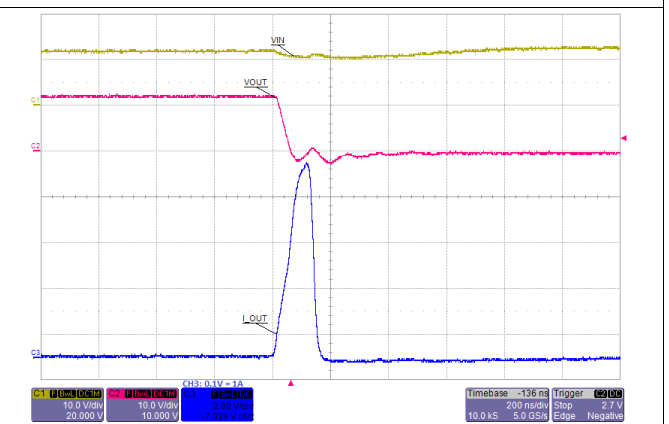
TPS259251/61,  $V_{VIN} = 5\text{ V}$ ,  $C_{dVdT} = 1\text{ nF}$

Figure 32. Transient: Recovery from Short Circuit



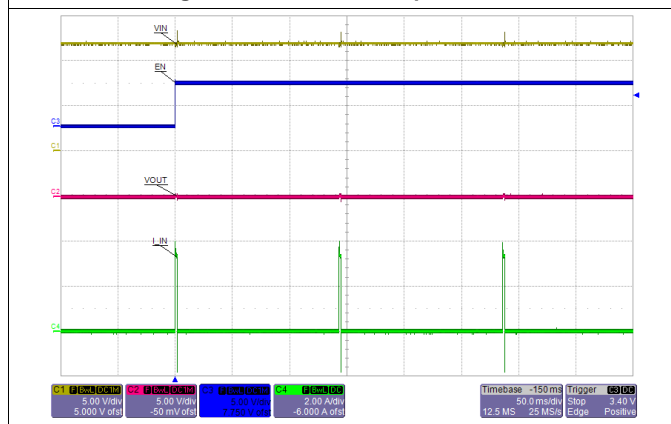
TPS25926x,  $V_{VIN} = 12\text{ V}$ ,  $R_{ILIM} = 150\text{ k}\Omega$

Figure 33. Transient: Output Short Circuit



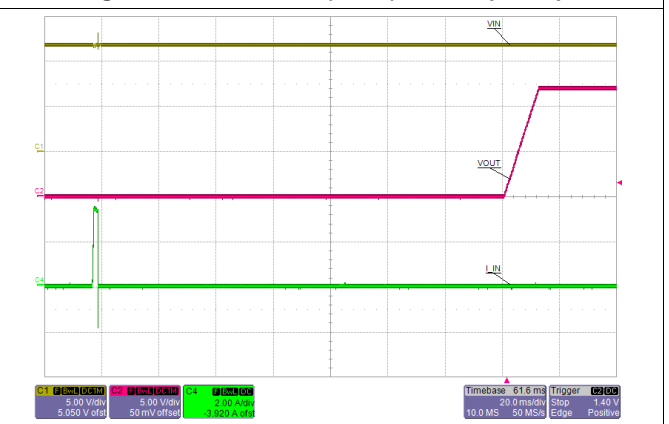
TPS25926x,  $V_{VIN} = 12\text{ V}$ ,  $R_{ILIM} = 150\text{ k}\Omega$

Figure 34. Short Circuit (Zoom): Fast-Trip Comparator



TPS25926x,  $V_{VIN} = 12\text{ V}$

Figure 35. Transient: Wake Up to Short Circuit

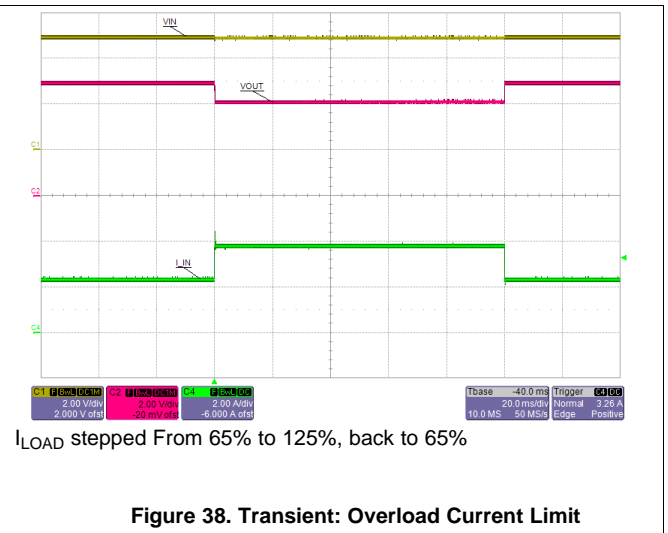
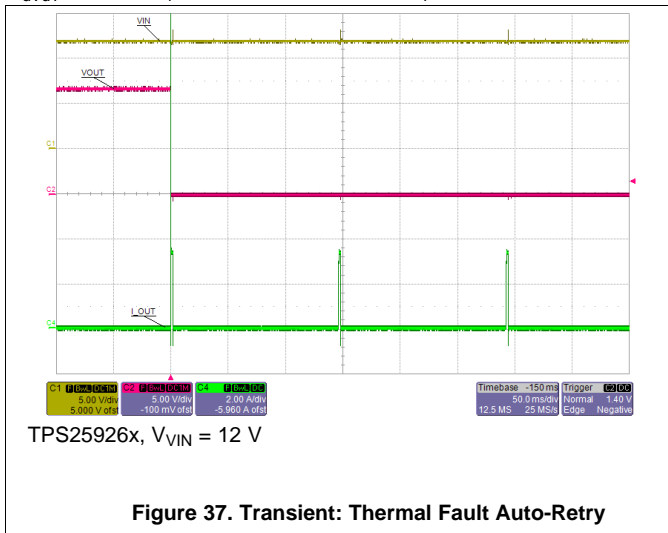


TPS25926x,  $V_{VIN} = 12\text{ V}$ ,  $C_{dVdT} = 1\text{ nF}$

Figure 36. Transient: Recovery from Short Circuit

Typical Characteristics (continued)

$T_J = 25^\circ\text{C}$ ,  $V_{VIN} = 12\text{ V}$  for TPS25926x,  $V_{VIN} = 5\text{ V}$  for TPS25925x,  $V_{EN/UVLO} = 2\text{ V}$ ,  $R_{ILIM} = 100\text{ k}\Omega$ ,  $C_{VIN} = 0.1\text{ }\mu\text{F}$ ,  $C_{OUT} = 1\text{ }\mu\text{F}$ ,  $C_{dVdT} = \text{OPEN}$  (unless stated otherwise)



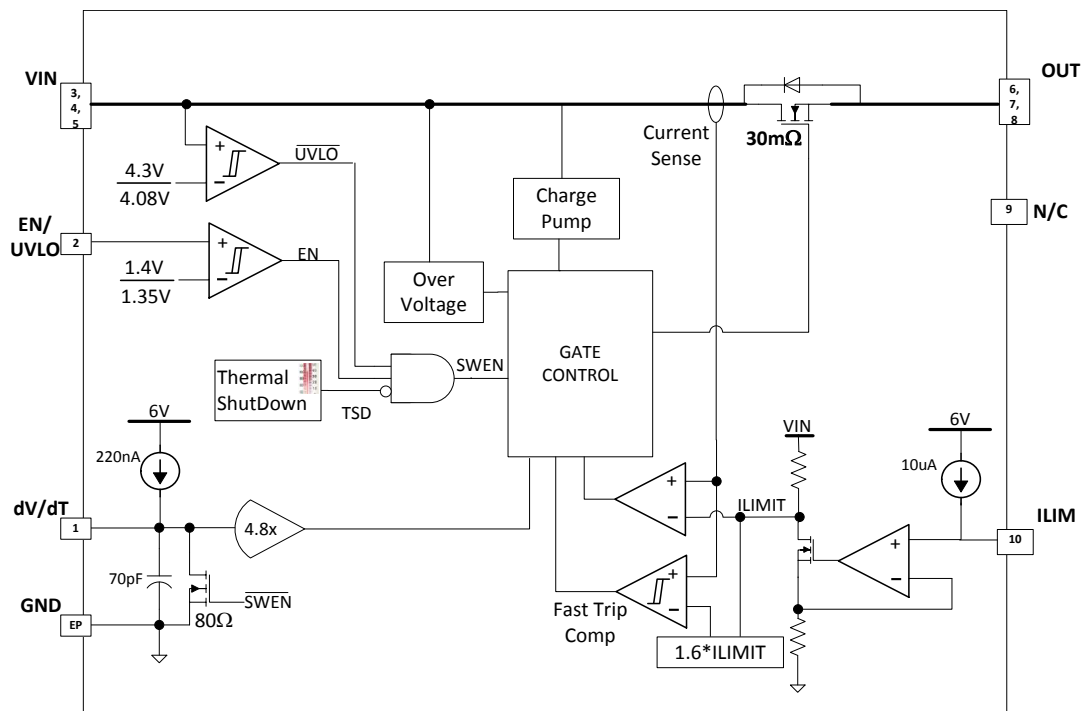
## 8 Detailed Description

### 8.1 Overview

The TPS25925x/6x is an e-fuse with integrated power switch that is used to manage current, voltage and start-up voltage ramp to a connected load. The device starts its operation by monitoring the VIN bus. When VIN exceeds the undervoltage-lockout threshold ( $V_{UVR}$ ), the device samples the EN/UVLO pin. A high level on this pin enables the internal MOSFET. As VIN rises, the internal MOSFET of the device starts conducting and allow current to flow from VIN to OUT. When EN/UVLO is held low (below  $V_{ENF}$ ), internal MOSFET is turned off. User also has the ability to modify the output voltage ramp time by connecting a capacitor between dV/dT pin and GND.

After a successful start-up sequence, the device now actively monitors its load current and input voltage, ensuring that the adjustable overload current limit IOL is not exceeded and input voltage spikes are safely clamped to VOVC level at the output. This keeps the output device safe from harmful voltage and current transients. The device also has built-in thermal sensor. In the event device temperature ( $T_J$ ) exceeds TSHDN, typically 150°C, the thermal shutdown circuitry shuts down the internal MOSFET thereby disconnecting the load from the supply. In TPS259250/60, the output remains disconnected (MOSFET open) until power to device is recycled or EN/UVLO is toggled (pulled low and then high). The TPS259251/61 device remains off and commences an auto-retry cycle of 145 ms after device temperature falls below  $T_{SHDN} - 10^\circ\text{C}$ . This auto-retry cycle continues until the fault is cleared.

### 8.2 Functional Block Diagram



### 8.3 Feature Description

#### 8.3.1 GND

This is the most negative voltage in the circuit and is used as a reference for all voltage measurements unless otherwise specified.

## Feature Description (continued)

### 8.3.2 VIN

Input voltage to the TPS25925x/6x. A ceramic bypass capacitor close to the device from VIN to GND is recommended to alleviate bus transients. The recommended operating voltage range is 4.5 V – 13.8 V for TPS25926x and 4.5 V – 5.5 V for TPS25925x. The device can continuously sustain a voltage of 20 V on VIN pin. However, above the recommended maximum bus voltage, the device is in over-voltage protection (OVP) mode, limiting the output voltage to  $V_{OVC}$ . The power dissipation in OVP mode is  $P_{D\_OVP} = (V_{VIN} - V_{OVC}) \times I_{OUT}$ , which can potentially heat up the device and cause thermal shutdown.

### 8.3.3 dV/dT

Connect a capacitor from this pin to GND to control the slew rate of the output voltage at power-on. This pin can be left floating to obtain a predetermined slew rate (minimum  $T_{dVdT}$ ) on the output. Governing slew rate at start-up is shown in [Equation 1](#).

$$\frac{dV_{OUT}}{dt} = \frac{I_{dVdT} \times GAIN_{dVdT}}{C_{dVdT} + C_{INT}} \quad (1)$$

Where:

$$I_{dVdT} = 220 \text{ nA (TYPICAL)}$$

$$C_{INT} = 70 \text{ pF (TYPICAL)}$$

$$GAIN_{dVdT} = 4.85$$

$$\frac{dV_{OUT}}{dT} = \text{Desired output slew rate}$$

The total ramp time ( $T_{dVdT}$ ) for 0 to VIN can be calculated using [Equation 2](#).

$$T_{dVdT} = 10^6 \times V_{IN} \times (C_{dVdT} + 70 \text{ pF}) \quad (2)$$

For details on how to select an appropriate charging time/rate, see the applications section [Setting Output Voltage Ramp Time \( \$T\_{dVdT}\$ \)](#).

### 8.3.4 EN/UVLO

As an input pin, it controls both the ON and OFF state of the internal MOSFET. In its high state, the internal MOSFET is enabled and allows current to flow from VIN to OUT. A low on this pin turns off the internal MOSFET. High and Low levels are specified in the parametric table of the datasheet. The EN/UVLO pin is also used to clear a thermal shutdown latch in the TPS259250/60 by toggling this pin (H→L).

The internal de-glitch delay on EN/UVLO falling edge is intentionally kept low (1  $\mu$ s typical) for quick detection of power failure. For applications where a higher de-glitch delay on EN/UVLO is desired, or when the supply is particularly noisy, it is recommended to use an external bypass capacitor from EN/UVLO to GND.

### 8.3.5 ILIM

The device continuously monitors the load current and keeps it limited to the value programmed by  $R_{ILIM}$ . After start-up event and during normal operation, current limit is set to  $I_{OL}$  (over-load current limit). See [Equation 3](#).

$$I_{OL} = (0.7 + 3 \times 10^{-5} \times R_{ILIM}) \quad (3)$$

When power dissipation in the internal MOSFET [ $P_D = (V_{VIN} - V_{OUT}) \times I_{OUT}$ ] exceeds 10 W, there is a 2% to 12% thermal foldback in the current limit value so that  $I_{OL}$  drops to  $I_{SC}$ . In each of the two modes, MOSFET gate voltage is regulated to throttle short-circuit and overload current flowing to the load. Eventually, the device shuts down due to over temperature. See [Figure 39](#).

Feature Description (continued)

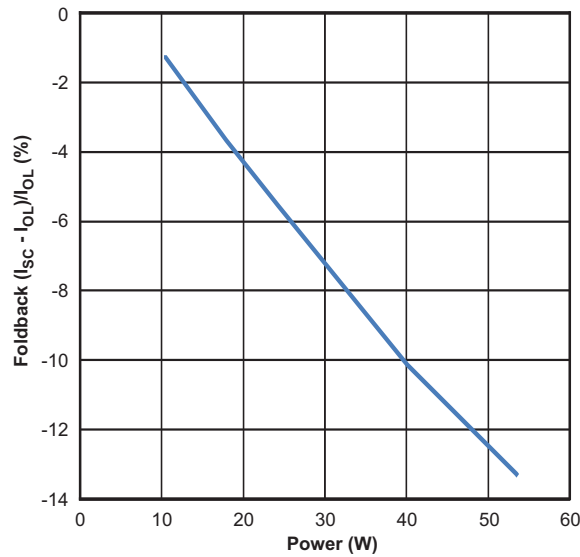


Figure 39. Thermal Foldback in Current Limit

During a transient short circuit event, the current through the device increases very rapidly. The current-limit amplifier cannot respond to this event because of its limited bandwidth. Therefore, the TPS25925/6 incorporates a fast-trip comparator, which shuts down the pass device when  $I_{OUT} > I_{FASTRIP}$ , and terminates the rapid short-circuit peak current. The trip threshold is set to 60% higher than the programmed over-load current limit ( $I_{FASTRIP} = 1.6 \times I_{OL}$ ). After the transient short-circuit peak current has been terminated by the fast-trip comparator, the current limit amplifier smoothly regulates the output current to  $I_{OL}$ . See Figure 40 and Figure 41.

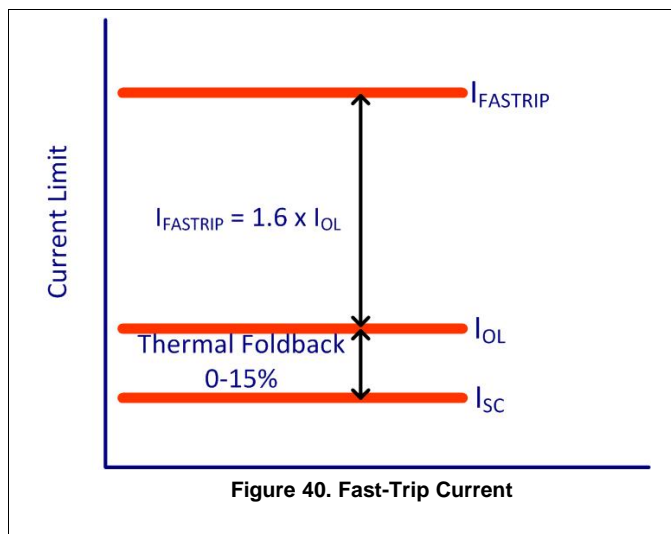


Figure 40. Fast-Trip Current

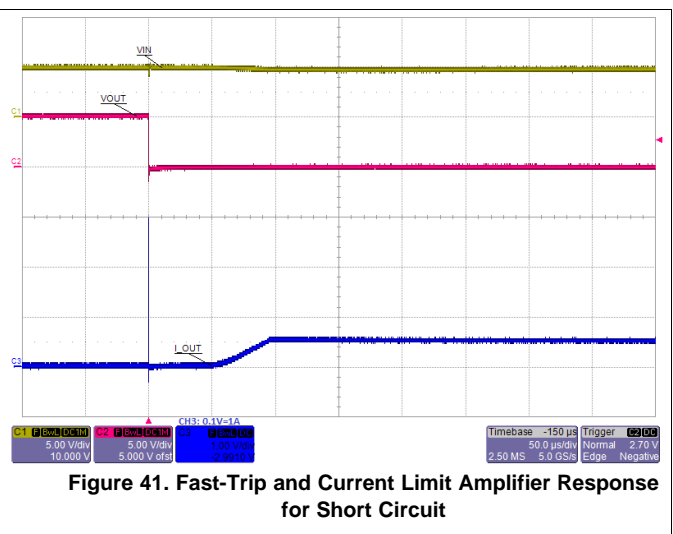


Figure 41. Fast-Trip and Current Limit Amplifier Response for Short Circuit



## 8.4 Device Functional Modes

The TPS25925x/6x is a hot-swap controller with integrated power switch that is used to manage current, voltage and start-up voltage ramp to a connected load. The device starts its operation by monitoring the VIN bus. When  $V_{VIN}$  exceeds the undervoltage-lockout threshold ( $V_{UVLO}$ ), the device samples the EN/UVLO pin. A high level on this pin enables the internal MOSFET. As VIN rises, the internal MOSFET of the device starts conducting and allows current to flow from VIN to OUT. When EN/UVLO is held low (that is, below  $V_{ENF}$ ), the internal MOSFET is turned off; thereby, blocking the flow of current from VIN to OUT. The user can modify the output voltage ramp time by connecting a capacitor between dV/dT pin and GND.

Having successfully completed its start-up sequence, the device now actively monitors the load current and input voltage, ensuring that the adjustable overload current limit  $I_{OL}$  is not exceeded and input voltage spikes are safely clamped to  $V_{OVC}$  level at the output. This keeps the output device safe from harmful voltage and current transients. The device also has built-in thermal sensor. If the device temperature ( $T_J$ ) exceeds  $T_{SHDN}$ , typically 150°C, the thermal shutdown circuitry shuts down the internal MOSFET; thereby, disconnecting the load from the supply. In the TPS259250/60, the output remains disconnected (MOSFET open) until power to device is recycled or EN/UVLO is toggled (pulled low and then high). The TPS259251/61 device remains off and commences an auto-retry cycle of 145 ms after device temperature falls below  $T_{SHDN} - 10^\circ\text{C}$ . This auto-retry cycle continues until the fault is cleared.

## 9 Application and Implementation

### NOTE

Information in the following applications sections is not part of the TI component specification, and TI does not warrant its accuracy or completeness. TI's customers are responsible for determining suitability of components for their purposes. Customers should validate and test their design implementation to confirm system functionality.

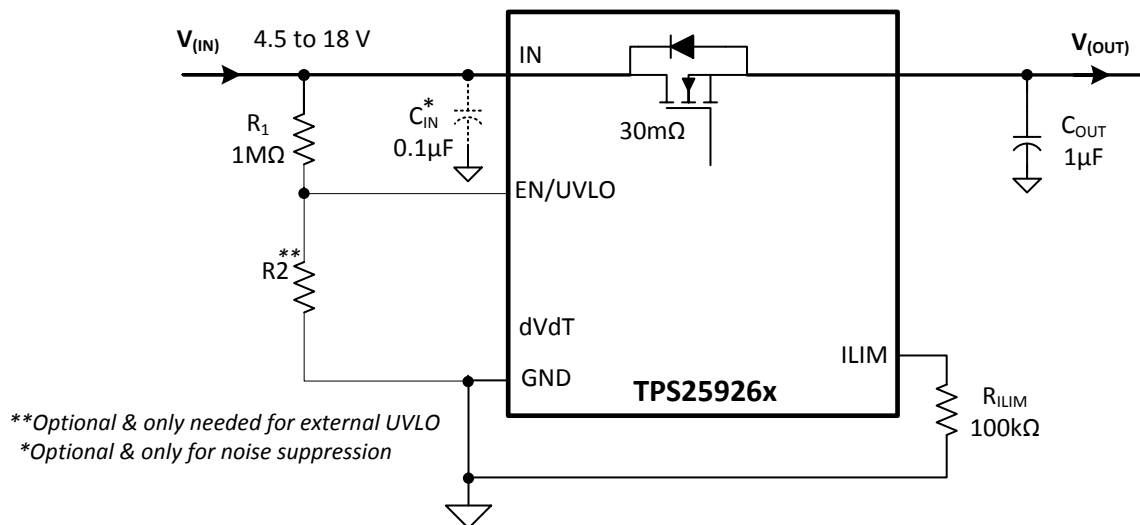
### 9.1 Application Information

The TPA25925x/6x is a smart eFuse. It is typically used for Hot-Swap and Power rail protection applications. It operates from 4.5 V to 18 V with programmable current limit and undervoltage protection. The device aids in controlling the in-rush current and provides precise current limiting during overload conditions for systems such as Set-Top-Box, DTVs, Gaming Consoles, SSDs, HDDs and Smart Meters. The device also provides robust protection for multiple faults on the sub-system rail.

The following can be used to select component values for the device.

Alternatively, the WEBENCH® software may be used to generate a complete design. The WEBENCH® software uses an iterative design procedure and accesses a comprehensive database of components when generating a design. Additionally, a spreadsheet design tool *TPS2592xx Design Calculator* ([SLUC570](#)) is available on web folder.

### 9.2 Typical Application



\*  $C_{IN}$  is optional and 0.1  $\mu\text{F}$  is recommended to suppress transients due to the inductance of PCB routing or from input wiring.

**Figure 42. Typical Application Schematic: Simple e-Fuse for Set Top Boxes**

#### 9.2.1 Design Requirements

Table 1 lists the TPA25925x/6x design requirements.

**Table 1. Design Parameters**

DESIGN PARAMETER	EXAMPLE VALUE
Input voltage, $V_{IN}$	12 V
Undervoltage lockout set point, $V_{(UV)}$	Default: $V_{UVR} = 4.3 \text{ V}$
Overvoltage protection set point, $V_{(OV)}$	Default: $V_{OVC} = 15 \text{ V}$
Load at start-up, $R_{L(SU)}$	4 $\Omega$

## Typical Application (continued)

**Table 1. Design Parameters (continued)**

DESIGN PARAMETER	EXAMPLE VALUE
Current limit, I <sub>OL</sub>	3.7 A
Load capacitance, C <sub>OUT</sub>	1 μF
Maximum ambient temperatures, T <sub>A</sub>	85°C

### 9.2.2 Detailed Design Procedure

To begin the design process a few parameters must be decided upon. The designer needs to know the following:

- Normal input operation voltage
- Maximum output capacitance
- Maximum current Limit
- Load during start-up
- Maximum ambient temperature of operation

This design procedure below seeks to control the junction temperature of device under both static and transient conditions by proper selection of output ramp-up time and associated support components. The designer can adjust this procedure to fit the application and design criteria.

#### 9.2.2.1 Programming the Current-Limit Threshold: R<sub>ILIM</sub> Selection

The R<sub>ILIM</sub> resistor at the ILIM pin sets the over load current limit, this can be set using [Equation 4](#).

$$R_{ILIM} = \frac{I_{ILIM} - 0.7}{3 \times 10^{-5}} \quad (4)$$

For I<sub>ILIM</sub> = 3.7 A, from [Equation 4](#), R<sub>ILIM</sub> is 100 kΩ, choose closest standard value resistor with 1% tolerance.

#### 9.2.2.2 Undervoltage Lockout Set Point

The undervoltage lockout (UVLO) trip point is adjusted using the external voltage divider network of R<sub>1</sub> and R<sub>2</sub> as connected between IN, EN/UVLO and GND pins of the device. The values required for setting the undervoltage are calculated solving [Equation 5](#).

$$V_{(UV)} = \frac{R_1 + R_2}{R_2} \times V_{ENR} \quad (5)$$

Where V<sub>ENR</sub> is enable voltage rising threshold (1.4 V). Because R<sub>1</sub> and R<sub>2</sub> leak the current from input supply (V<sub>in</sub>), these resistors must be selected based on the acceptable leakage current from input power supply (V<sub>in</sub>).

The current drawn by R<sub>1</sub> and R<sub>2</sub> from the power supply  $\{I_{(R12)} = V_{(IN)}/(R_1 + R_2)\}$ .

However, leakage currents due to external active components connected to the resistor string can add error to these calculations. So, the resistor string current, I<sub>(R12)</sub> must be chosen to be 20x greater than the leakage current expected.

For default UVLO of V<sub>UVR</sub> = 4.3 V, select R<sub>2</sub> = OPEN, and R<sub>1</sub> = 1 MΩ. Because EN/UVLO pin is rated only to 7 V, it cannot be connected directly to V<sub>IN</sub> = 12 V. It has to be connected through R<sub>1</sub> = 1 MΩ only, so that the pull-up current for EN/UVLO pin is limited to < 20 μA.

The power failure threshold is detected on the falling edge of supply. This threshold voltage is 4% lower than the rising threshold, V<sub>UVR</sub>. This is calculated using [Equation 6](#).

$$V_{(PFAIL)} = 0.96 \times V_{UVR} \quad (6)$$

Where V<sub>UVR</sub> is 4.3 V, Power fail threshold set is : 4.1 V.

#### 9.2.2.3 Setting Output Voltage Ramp Time (T<sub>dVdT</sub>)

For a successful design, the junction temperature of device must be kept below the absolute-maximum rating during both dynamic (start-up) and steady state conditions. Dynamic power stresses often are an order of magnitude greater than the static stresses, so it is important to determine the right start-up time and in-rush current limit required with system capacitance to avoid thermal shutdown during start-up with and without load.

The ramp-up capacitor  $C_{dVdT}$  needed is calculated considering the two possible cases.

### 9.2.2.3.1 Case 1: Start-Up without Load: Only Output Capacitance $C_{OUT}$ Draws Current During Start-Up

During start-up, as the output capacitor charges, the voltage difference as well as the power dissipated across the internal FET decreases. The average power dissipated in the device during start-up is calculated using Equation 8.

For TPS25926x device, the inrush current is determined as shown in Equation 7.

$$I_{(INRUSH)} = C_{(OUT)} \times \frac{V_{(IN)}}{T_{dVdT}} \quad (7)$$

Power dissipation during start-up is:

$$P_{D(INRUSH)} = 0.5 \times V_{(IN)} \times I_{(INRUSH)} \quad (8)$$

Equation 8 assumes that load does not draw any current until the output voltage has reached its final value.

### 9.2.2.3.2 Case 2: Start-Up with Load: Output Capacitance $C_{OUT}$ and Load Draws Current During Start-Up

When load draws current during the turn-on sequence, there is additional power dissipated. Considering a resistive load during start-up ( $R_{L(SU)}$ ), load current ramps up proportionally with increase in output voltage during  $T_{dVdT}$  time. Equation 9 to Equation 12 show the average power dissipation in the internal FET during charging time due to resistive load.

$$P_{D(LOAD)} = \left(\frac{1}{6}\right) \times \frac{V_{(IN)}^2}{R_{L(SU)}} \quad (9)$$

Total power dissipated in the device during startup is:

$$P_{D(STARTUP)} = P_{D(INRUSH)} + P_{D(LOAD)} \quad (10)$$

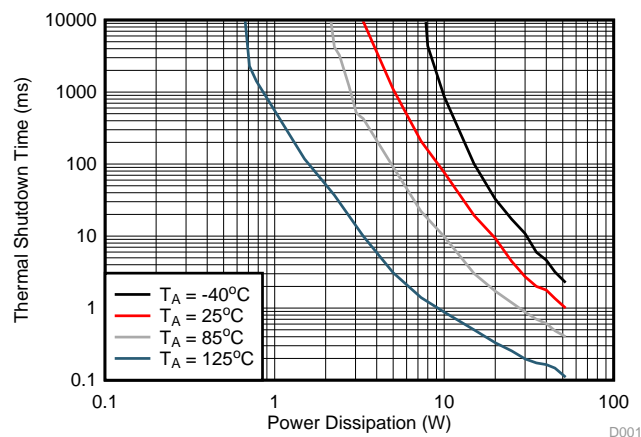
Total current during startup is given by:

$$I_{(STARTUP)} = I_{(INRUSH)} + I_L(t) \quad (11)$$

If  $I_{(STARTUP)} > I_{OL}$ , the device limits the current to  $I_{OL}$  and the current limited charging time is determined by:

$$T_{dVdT(\text{Current-Limited})} = C_{OUT} \times R_{L(SU)} \times \left[ \frac{I_{OL}}{I_{(INRUSH)}} - 1 + \text{LN} \left( \frac{I_{(INRUSH)}}{I_{OL} - \frac{V_{(IN)}}{R_{L(SU)}}} \right) \right] \quad (12)$$

The power dissipation, with and without load, for selected start-up time must not exceed the shutdown limits as shown in Figure 43.



**Figure 43. Thermal Shutdown Limit Plot**

For the design example under discussion, select ramp-up capacitor  $C_{dVdT} = \text{OPEN}$ . Then, using Equation 2.

$$T_{dVdT} = 10^6 \times 12 \times (0 + 70 \text{ pF}) = 840 \text{ } \mu\text{s} \quad (13)$$

The inrush current drawn by the load capacitance ( $C_{OUT}$ ) during ramp-up using [Equation 14](#).

$$I_{(INRUSH)} = 1 \text{ } \mu\text{F} \times \frac{12}{840 \text{ } \mu\text{s}} = 15 \text{ mA} \quad (14)$$

The inrush power dissipation is calculated using [Equation 15](#).

$$P_{D(INRUSH)} = 0.5 \times 12 \times 15 \text{ m} = 90 \text{ mW} \quad (15)$$

For 90 mW of power loss, the thermal shut down time of the device must not be less than the ramp-up time  $T_{dVdT}$  to avoid the false trip at maximum operating temperature. From thermal shutdown limit graph [Figure 43](#) at  $T_A = 85^\circ\text{C}$ , for 90 mW of power, the shutdown time is infinite. So it is safe to use 0.79 ms as start-up time without any load on output.

Considering the start-up with load 4  $\Omega$ , the additional power dissipation, when load is present during start up is calculated using [Equation 9](#).

$$P_{D(LOAD)} = \frac{12 \times 12}{6 \times 4} = 6 \text{ W} \quad (16)$$

The total device power dissipation during start up is given in [Equation 17](#).

$$P_{D(STARTUP)} = 6 + 90 \text{ m} = 6.09 \text{ W} \quad (17)$$

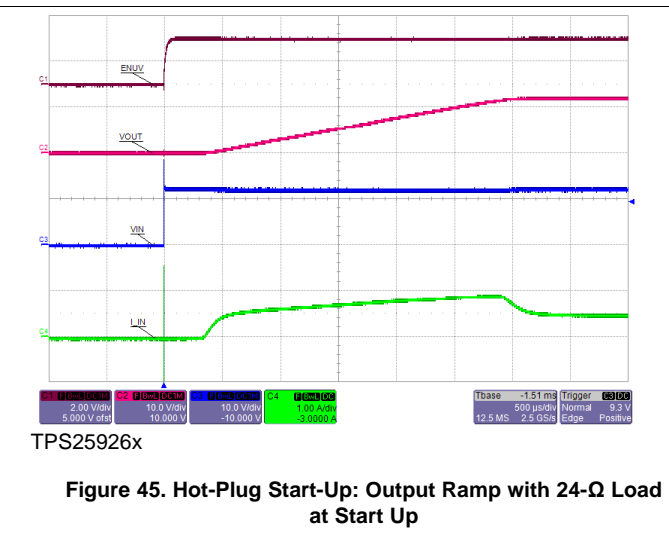
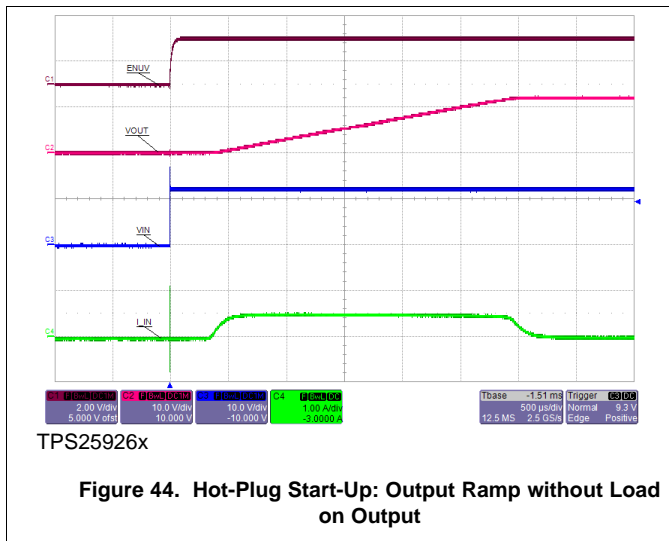
From thermal shutdown limit graph at  $T_A = 85^\circ\text{C}$ , the thermal shutdown time for 6.09 W is more than 10 ms. So it is well within acceptable limits to use no external capacitor ( $C_{dV/dT}$ ) with start-up load of 4  $\Omega$ .

If, due to large  $C_{OUT}$ , there is a need to decrease the power loss during start-up, it can be done with increase of  $C_{dV/dT}$  capacitor.

#### 9.2.2.4 Support Component Selection— $C_{VIN}$

$C_{VIN}$  is a bypass capacitor to help control transient voltages, unit emissions, and local supply noise. Where acceptable, a value in the range of 0.001  $\mu\text{F}$  to 0.1  $\mu\text{F}$  is recommended for  $C_{VIN}$ .

### 9.2.3 Application Curves



## 10 Power Supply Recommendations

The device is designed for supply voltage range of  $4.5\text{ V} \leq V_{\text{IN}} \leq 18\text{ V}$ . If the input supply is located more than a few inches from the device an input ceramic bypass capacitor higher than  $0.1\text{ }\mu\text{F}$  is recommended. Power supply must be rated higher than the current limit set to avoid voltage droops during over current and short-circuit conditions.

### 10.1 Transient Protection

In case of short circuit and over load current limit, when the device interrupts current flow, input inductance generates a positive voltage spike on the input and output inductance generates a negative voltage spike on the output. The peak amplitude of voltage spikes (transients) is dependent on value of inductance in series to the input or output of the device. Such transients can exceed the *Absolute Maximum Ratings* of the device if steps are not taken to address the issue.

Typical methods for addressing transients include:

- Minimizing lead length and inductance into and out of the device
- Using large PCB GND plane
- Schottky diode across the output to absorb negative spikes
- A low value ceramic capacitor ( $C_{\text{IN}} = 0.001\text{ }\mu\text{F}$  to  $0.1\text{ }\mu\text{F}$ ) to absorb the energy and dampen the transients. The approximate value of input capacitance can be estimated with [Equation 18](#).

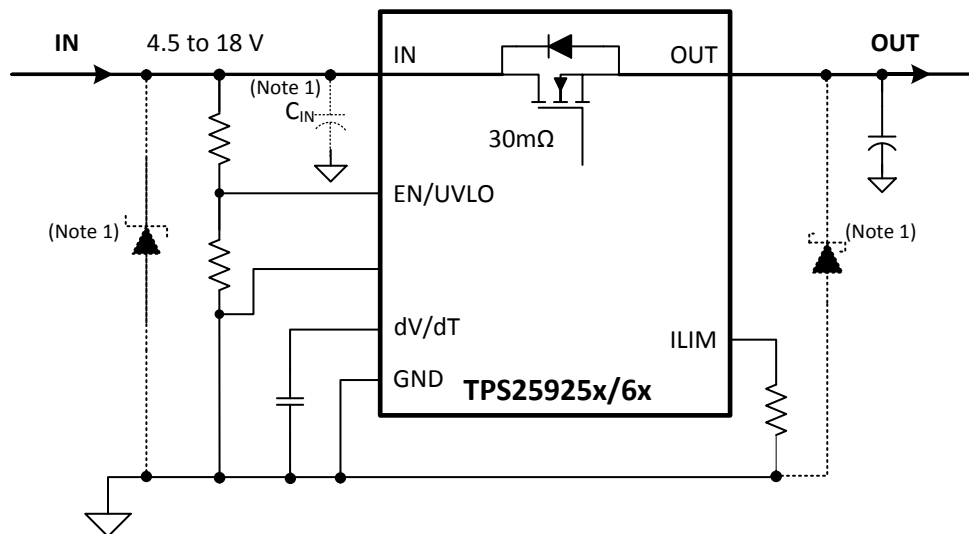
$$V_{\text{SPIKE(Absolute)}} = V_{\text{(IN)}} + I_{\text{(LOAD)}} \times \sqrt{\frac{L_{\text{(IN)}}}{C_{\text{(IN)}}}} \quad (18)$$

Where:

- $V_{\text{(IN)}}$  is the nominal supply voltage
- $I_{\text{(LOAD)}}$  is the load current
- $L_{\text{(IN)}}$  equals the effective inductance seen looking into the source
- $C_{\text{(IN)}}$  is the capacitance present at the input

Some applications may require the addition of a Transient Voltage Suppressor (TVS) to prevent transients from exceeding the *Absolute Maximum Ratings* of the device.

The circuit implementation with optional protection components (a ceramic capacitor, TVS and schottky diode) is shown in [Figure 46](#).



(1) Optional components needed for suppression of transients

**Figure 46. Circuit Implementation with Optional Protection Components**

## 10.2 Output Short-Circuit Measurements

It is difficult to obtain repeatable and similar short-circuit testing results. Source bypassing, input leads, circuit layout and component selection, output shorting method, relative location of the short, and instrumentation all contribute to variation in results. The actual short itself exhibits a certain degree of randomness as it microscopically bounces and arcs. Care in configuration and methods must be used to obtain realistic results. Do not expect to see waveforms exactly like those in the data sheet; every setup differs.

## 11 Layout

### 11.1 Layout Guidelines

- For all applications, a 0.01- $\mu$ F or greater ceramic decoupling capacitor is recommended between IN terminal and GND. For hot-plug applications, where input power path inductance is negligible, this capacitor can be eliminated/minimized.
- The optimum placement of decoupling capacitor is closest to the IN and GND terminals of the device. Care must be taken to minimize the loop area formed by the bypass-capacitor connection, the IN terminal, and the GND terminal of the IC. See [Figure 47](#) for a PCB layout example.
- High current carrying power path connections must be as short as possible and must be sized to carry at least twice the full-load current.
- The GND terminal must be tied to the PCB ground plane at the terminal of the IC. The PCB ground must be a copper plane or island on the board.
- Locate all TPS25925x/6x support components:  $R_{ILIM}$ ,  $C_{dVdT}$  and resistors for ENUV, close to their connection pin. Connect the other end of the component to the GND pin of the device with shortest trace length. The trace routing for the  $R_{ILIM}$  and  $C_{dVdT}$  components to the device must be as short as possible to reduce parasitic effects on the current limit and soft start timing. These traces must not have any coupling to switching signals on the board.
- Protection devices such as TVS, snubbers, capacitors, or diodes must be placed physically close to the device they are intended to protect, and routed with short traces to reduce inductance. For example, a protection Schottky diode is recommended to address negative transients due to switching of inductive loads, and it must be physically close to the OUT pins.
- Obtaining acceptable performance with alternate layout schemes is possible; however this layout has been shown to produce good results and is intended as a guideline.



## 11.2 Layout Example

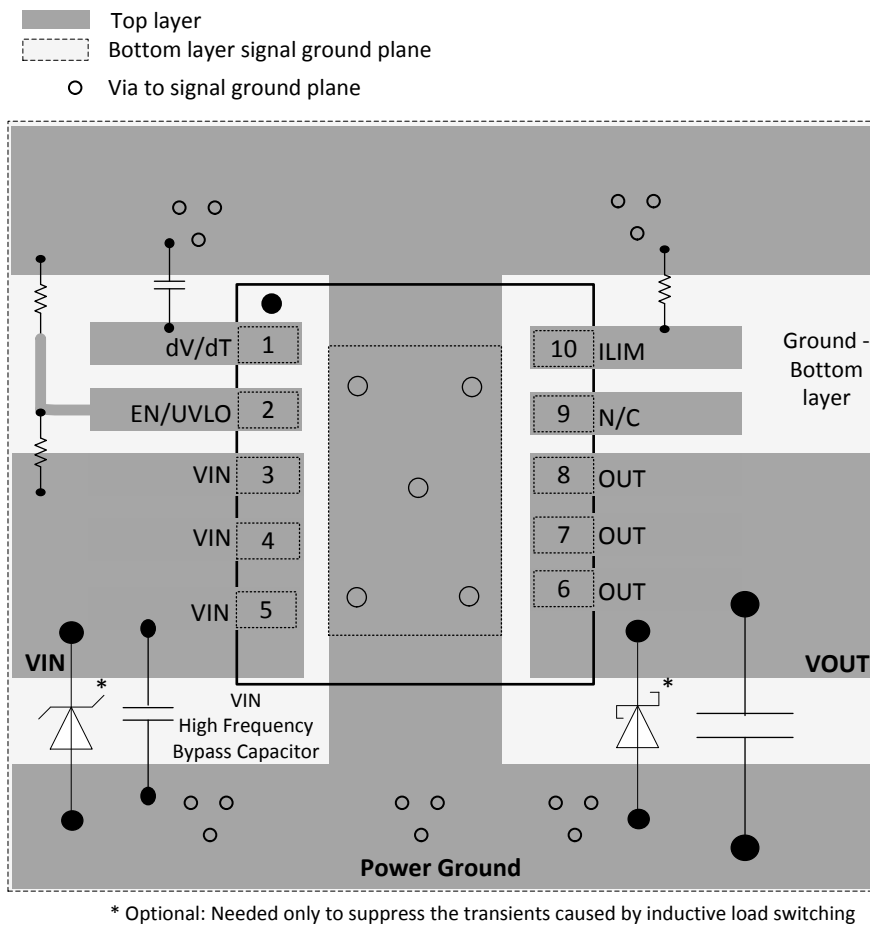


Figure 47. Layout Example

## 12 Device and Documentation Support

### 12.1 Device Support

#### 12.1.1 Third-Party Products Disclaimer

TI'S PUBLICATION OF INFORMATION REGARDING THIRD-PARTY PRODUCTS OR SERVICES DOES NOT CONSTITUTE AN ENDORSEMENT REGARDING THE SUITABILITY OF SUCH PRODUCTS OR SERVICES OR A WARRANTY, REPRESENTATION OR ENDORSEMENT OF SUCH PRODUCTS OR SERVICES, EITHER ALONE OR IN COMBINATION WITH ANY TI PRODUCT OR SERVICE.

### 12.2 Documentation Support

#### 12.2.1 Related Documentation

For related documentation see the following:

- *TPS2592xx Design Calculator*, [SLUC570](#)
- *TPS259250-61EVM: Evaluation Module for TPS259250/61*, [SLUUB64](#)

#### 12.3 Related Links

The table below lists quick access links. Categories include technical documents, support and community resources, tools and software, and quick access to sample or buy.

**Table 2. Related Links**

PARTS	PRODUCT FOLDER	SAMPLE & BUY	TECHNICAL DOCUMENTS	TOOLS & SOFTWARE	SUPPORT & COMMUNITY
TPS259250	<a href="#">Click here</a>	<a href="#">Click here</a>	<a href="#">Click here</a>	<a href="#">Click here</a>	<a href="#">Click here</a>
TPS259251	<a href="#">Click here</a>	<a href="#">Click here</a>	<a href="#">Click here</a>	<a href="#">Click here</a>	<a href="#">Click here</a>
TPS259260	<a href="#">Click here</a>	<a href="#">Click here</a>	<a href="#">Click here</a>	<a href="#">Click here</a>	<a href="#">Click here</a>
TPS259261	<a href="#">Click here</a>	<a href="#">Click here</a>	<a href="#">Click here</a>	<a href="#">Click here</a>	<a href="#">Click here</a>

#### 12.4 Receiving Notification of Documentation Updates

To receive notification of documentation updates, navigate to the device product folder on [ti.com](http://ti.com). In the upper right corner, click on Alert me to register and receive a weekly digest of any product information that has changed. For change details, review the revision history included in any revised document

#### 12.5 Community Resources

The following links connect to TI community resources. Linked contents are provided "AS IS" by the respective contributors. They do not constitute TI specifications and do not necessarily reflect TI's views; see TI's [Terms of Use](#).

**TI E2E™ Online Community** *TI's Engineer-to-Engineer (E2E) Community*. Created to foster collaboration among engineers. At [e2e.ti.com](http://e2e.ti.com), you can ask questions, share knowledge, explore ideas and help solve problems with fellow engineers.

**Design Support** *TI's Design Support* Quickly find helpful E2E forums along with design support tools and contact information for technical support.

#### 12.6 Trademarks

E2E is a trademark of Texas Instruments.  
All other trademarks are the property of their respective owners.

#### 12.7 Electrostatic Discharge Caution



This integrated circuit can be damaged by ESD. Texas Instruments recommends that all integrated circuits be handled with appropriate precautions. Failure to observe proper handling and installation procedures can cause damage.

ESD damage can range from subtle performance degradation to complete device failure. Precision integrated circuits may be more susceptible to damage because very small parametric changes could cause the device not to meet its published specifications.

## 12.8 Glossary

[SLYZ022](#) — *TI Glossary*.

This glossary lists and explains terms, acronyms, and definitions.

## 13 Mechanical, Packaging, and Orderable Information

The following pages include mechanical, packaging, and orderable information. This information is the most current data available for the designated devices. This data is subject to change without notice and revision of this document. For browser-based versions of this data sheet, refer to the left-hand navigation.

**PACKAGING INFORMATION**

Orderable Device	Status (1)	Package Type	Package Drawing	Pins	Package Qty	Eco Plan (2)	Lead finish/ Ball material (6)	MSL Peak Temp (3)	Op Temp (°C)	Device Marking (4/5)	Samples
TPS259250DRCR	ACTIVE	VSON	DRC	10	3000	RoHS & Green	NIPDAU	Level-2-260C-1 YEAR	-40 to 85	259250	<a href="#">Samples</a>
TPS259250DRCT	ACTIVE	VSON	DRC	10	250	RoHS & Green	NIPDAU	Level-2-260C-1 YEAR	-40 to 85	259250	<a href="#">Samples</a>
TPS259251DRCR	ACTIVE	VSON	DRC	10	3000	RoHS & Green	NIPDAU	Level-2-260C-1 YEAR	-40 to 85	259251	<a href="#">Samples</a>
TPS259251DRCT	ACTIVE	VSON	DRC	10	250	RoHS & Green	NIPDAU	Level-2-260C-1 YEAR	-40 to 85	259251	<a href="#">Samples</a>
TPS259260DRCR	ACTIVE	VSON	DRC	10	3000	RoHS & Green	NIPDAU	Level-2-260C-1 YEAR	-40 to 85	259260	<a href="#">Samples</a>
TPS259260DRCT	ACTIVE	VSON	DRC	10	250	RoHS & Green	NIPDAU	Level-2-260C-1 YEAR	-40 to 85	259260	<a href="#">Samples</a>
TPS259261DRCR	ACTIVE	VSON	DRC	10	3000	RoHS & Green	NIPDAU	Level-2-260C-1 YEAR	-40 to 85	259261	<a href="#">Samples</a>
TPS259261DRCT	ACTIVE	VSON	DRC	10	250	RoHS & Green	NIPDAU	Level-2-260C-1 YEAR	-40 to 85	259261	<a href="#">Samples</a>

(1) The marketing status values are defined as follows:

**ACTIVE:** Product device recommended for new designs.

**LIFEBUY:** TI has announced that the device will be discontinued, and a lifetime-buy period is in effect.

**NRND:** Not recommended for new designs. Device is in production to support existing customers, but TI does not recommend using this part in a new design.

**PREVIEW:** Device has been announced but is not in production. Samples may or may not be available.

**OBSELETE:** TI has discontinued the production of the device.

(2) **RoHS:** TI defines "RoHS" to mean semiconductor products that are compliant with the current EU RoHS requirements for all 10 RoHS substances, including the requirement that RoHS substance do not exceed 0.1% by weight in homogeneous materials. Where designed to be soldered at high temperatures, "RoHS" products are suitable for use in specified lead-free processes. TI may reference these types of products as "Pb-Free".

**RoHS Exempt:** TI defines "RoHS Exempt" to mean products that contain lead but are compliant with EU RoHS pursuant to a specific EU RoHS exemption.

**Green:** TI defines "Green" to mean the content of Chlorine (Cl) and Bromine (Br) based flame retardants meet JS709B low halogen requirements of <=1000ppm threshold. Antimony trioxide based flame retardants must also meet the <=1000ppm threshold requirement.

(3) MSL, Peak Temp. - The Moisture Sensitivity Level rating according to the JEDEC industry standard classifications, and peak solder temperature.

(4) There may be additional marking, which relates to the logo, the lot trace code information, or the environmental category on the device.

(5) Multiple Device Markings will be inside parentheses. Only one Device Marking contained in parentheses and separated by a "~" will appear on a device. If a line is indented then it is a continuation of the previous line and the two combined represent the entire Device Marking for that device.

<sup>(6)</sup> Lead finish/Ball material - Orderable Devices may have multiple material finish options. Finish options are separated by a vertical ruled line. Lead finish/Ball material values may wrap to two lines if the finish value exceeds the maximum column width.

**Important Information and Disclaimer:** The information provided on this page represents TI's knowledge and belief as of the date that it is provided. TI bases its knowledge and belief on information provided by third parties, and makes no representation or warranty as to the accuracy of such information. Efforts are underway to better integrate information from third parties. TI has taken and continues to take reasonable steps to provide representative and accurate information but may not have conducted destructive testing or chemical analysis on incoming materials and chemicals. TI and TI suppliers consider certain information to be proprietary, and thus CAS numbers and other limited information may not be available for release.

In no event shall TI's liability arising out of such information exceed the total purchase price of the TI part(s) at issue in this document sold by TI to Customer on an annual basis.

**TAPE AND REEL INFORMATION**

**QUADRANT ASSIGNMENTS FOR PIN 1 ORIENTATION IN TAPE**


\*All dimensions are nominal

Device	Package Type	Package Drawing	Pins	SPQ	Reel Diameter (mm)	Reel Width W1 (mm)	A0 (mm)	B0 (mm)	K0 (mm)	P1 (mm)	W (mm)	Pin1 Quadrant
TPS259250DRCR	VSON	DRC	10	3000	330.0	12.4	3.3	3.3	1.1	8.0	12.0	Q2
TPS259250DRCT	VSON	DRC	10	250	180.0	12.4	3.3	3.3	1.1	8.0	12.0	Q2
TPS259251DRCR	VSON	DRC	10	3000	330.0	12.4	3.3	3.3	1.1	8.0	12.0	Q2
TPS259251DRCT	VSON	DRC	10	250	180.0	12.4	3.3	3.3	1.1	8.0	12.0	Q2
TPS259251DRCT	VSON	DRC	10	250	180.0	12.4	3.3	3.3	1.1	8.0	12.0	Q2
TPS259260DRCR	VSON	DRC	10	3000	330.0	12.4	3.3	3.3	1.1	8.0	12.0	Q2
TPS259260DRCT	VSON	DRC	10	250	180.0	12.4	3.3	3.3	1.1	8.0	12.0	Q2
TPS259261DRCR	VSON	DRC	10	3000	330.0	12.4	3.3	3.3	1.1	8.0	12.0	Q2
TPS259261DRCT	VSON	DRC	10	250	180.0	12.4	3.3	3.3	1.1	8.0	12.0	Q2
TPS259261DRCT	VSON	DRC	10	250	180.0	12.4	3.3	3.3	1.1	8.0	12.0	Q2

**TAPE AND REEL BOX DIMENSIONS**


\*All dimensions are nominal

Device	Package Type	Package Drawing	Pins	SPQ	Length (mm)	Width (mm)	Height (mm)
TPS259250DRCR	VSON	DRC	10	3000	367.0	367.0	35.0
TPS259250DRCT	VSON	DRC	10	250	210.0	185.0	35.0
TPS259251DRCR	VSON	DRC	10	3000	367.0	367.0	35.0
TPS259251DRCR	VSON	DRC	10	3000	367.0	367.0	35.0
TPS259251DRCT	VSON	DRC	10	250	210.0	185.0	35.0
TPS259251DRCT	VSON	DRC	10	250	210.0	185.0	35.0
TPS259260DRCR	VSON	DRC	10	3000	367.0	367.0	35.0
TPS259260DRCT	VSON	DRC	10	250	210.0	185.0	35.0
TPS259261DRCR	VSON	DRC	10	3000	367.0	367.0	35.0
TPS259261DRCR	VSON	DRC	10	3000	367.0	367.0	35.0
TPS259261DRCT	VSON	DRC	10	250	210.0	185.0	35.0
TPS259261DRCT	VSON	DRC	10	250	210.0	185.0	35.0

## GENERIC PACKAGE VIEW

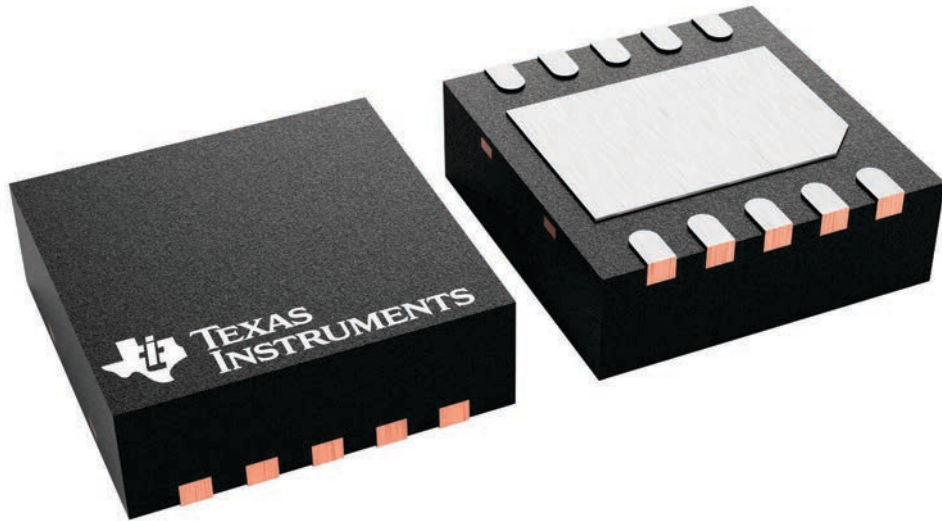
**DRC 10**

**VSON - 1 mm max height**

3 x 3, 0.5 mm pitch

PLASTIC SMALL OUTLINE - NO LEAD

This image is a representation of the package family, actual package may vary.  
Refer to the product data sheet for package details.



4226193/A





# EXAMPLE BOARD LAYOUT

DRC0010J

VSON - 1 mm max height

PLASTIC SMALL OUTLINE - NO LEAD



LAND PATTERN EXAMPLE  
EXPOSED METAL SHOWN  
SCALE:20X



SOLDER MASK DETAILS

4218878/B 07/2018

NOTES: (continued)

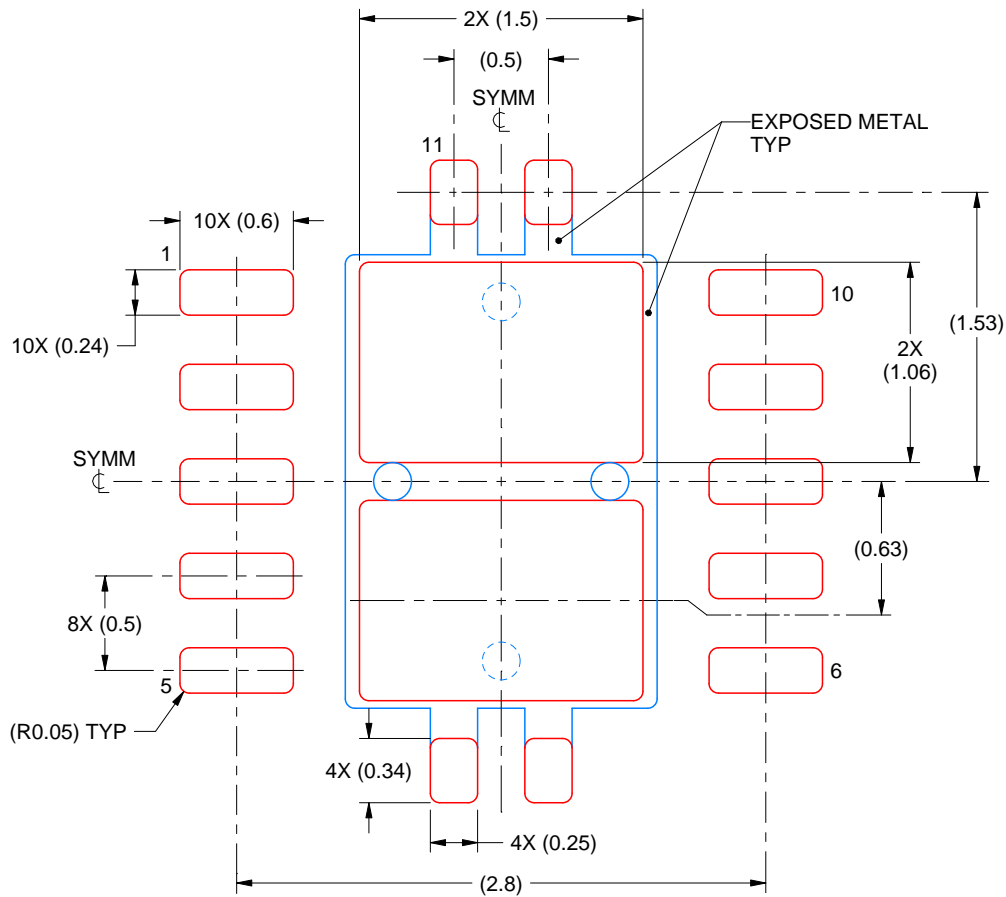
4. This package is designed to be soldered to a thermal pad on the board. For more information, see Texas Instruments literature number SLUA271 ([www.ti.com/lit/sluea271](http://www.ti.com/lit/sluea271)).
5. Vias are optional depending on application, refer to device data sheet. If any vias are implemented, refer to their locations shown on this view. It is recommended that vias under paste be filled, plugged or tented.

# EXAMPLE STENCIL DESIGN

DRC0010J

VSON - 1 mm max height

PLASTIC SMALL OUTLINE - NO LEAD



SOLDER PASTE EXAMPLE  
BASED ON 0.125 mm THICK STENCIL

EXPOSED PAD 11:  
80% PRINTED SOLDER COVERAGE BY AREA  
SCALE:25X

4218878/B 07/2018

NOTES: (continued)

6. Laser cutting apertures with trapezoidal walls and rounded corners may offer better paste release. IPC-7525 may have alternate design recommendations.

## IMPORTANT NOTICE AND DISCLAIMER

TI PROVIDES TECHNICAL AND RELIABILITY DATA (INCLUDING DATA SHEETS), DESIGN RESOURCES (INCLUDING REFERENCE DESIGNS), APPLICATION OR OTHER DESIGN ADVICE, WEB TOOLS, SAFETY INFORMATION, AND OTHER RESOURCES "AS IS" AND WITH ALL FAULTS, AND DISCLAIMS ALL WARRANTIES, EXPRESS AND IMPLIED, INCLUDING WITHOUT LIMITATION ANY IMPLIED WARRANTIES OF MERCHANTABILITY, FITNESS FOR A PARTICULAR PURPOSE OR NON-INFRINGEMENT OF THIRD PARTY INTELLECTUAL PROPERTY RIGHTS.

These resources are intended for skilled developers designing with TI products. You are solely responsible for (1) selecting the appropriate TI products for your application, (2) designing, validating and testing your application, and (3) ensuring your application meets applicable standards, and any other safety, security, regulatory or other requirements.

These resources are subject to change without notice. TI grants you permission to use these resources only for development of an application that uses the TI products described in the resource. Other reproduction and display of these resources is prohibited. No license is granted to any other TI intellectual property right or to any third party intellectual property right. TI disclaims responsibility for, and you will fully indemnify TI and its representatives against, any claims, damages, costs, losses, and liabilities arising out of your use of these resources.

TI's products are provided subject to [TI's Terms of Sale](#) or other applicable terms available either on [ti.com](https://www.ti.com) or provided in conjunction with such TI products. TI's provision of these resources does not expand or otherwise alter TI's applicable warranties or warranty disclaimers for TI products.

TI objects to and rejects any additional or different terms you may have proposed.

Mailing Address: Texas Instruments, Post Office Box 655303, Dallas, Texas 75265  
Copyright © 2023, Texas Instruments Incorporated